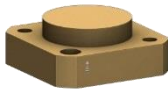

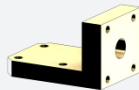
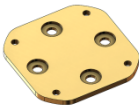
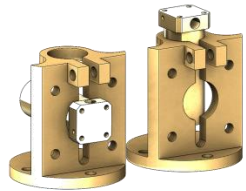

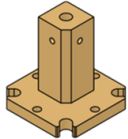
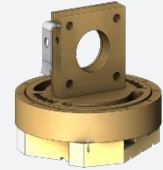



Types of Sample Mounts

Last Updated: July 28, 2015

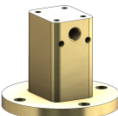
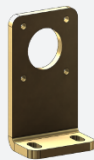
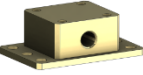


Image	Name	P/N	Base*	Top*	Height (mm)
FACE MOUNTS					
	CB 12 button	4100-006	MI small	flat	4.23
ADAPTERS					
	ANP stack adapter	4100-381	MI 101	MI small	5
	ANP stack adapter	4100-389	MI 101	MI small	6
	ANP stack adapter	4100-384	MI 101	MI small	10
	ANP stack adapter	4100-371	MI 101	MI small	11
	ANP stack adapter	4100-375A3	MI 101	MI small	15
	ANP stack adapter	4100-375A2	MI 101	MI small	17
	ANP stack adapter	4100-385	MI 101	MI small	17
	Right angle adapter	4100-475	MI small	MI small	
	Adapter under 101 stack	4100-360	Platform	MI 101	2
ADJUSTABLE MOUNTS					
	Standard mount (two shown)	4200-129	Platform	MI small	13 side, 39 to 58 top
	Adjustable Horizontal or Vertical	4100-1162	MI 101	MI small	31-43
	Adjustable Horizontal or Vertical	4100-1219	MI 101 or platform	MI small	
	Manual rotary	4100-1131	MI 101	MI small	9
ELECTRICAL MOUNTS					
Multiple styles available for both low voltage and high frequency connections. See Electrical Sample Mount Options .					
FLEX LINKS					
	51 series short, 12-20mm	4100-1107	Platform	MI 51	stack + 5mm
	51 series short, 20-30mm	4100-1212	Platform	MI 51	stack + 5mm
	51 series tall, 30-45mm	4100-1108	Platform	MI 51	stack + 5mm
	51 series tall, 45-60mm	4100-1110	Platform	MI 51	stack + 5mm

Types of Sample Mounts

Last Updated: July 28, 2015

	51 series narrow, for side by side	4100-1170	Platform	MI 51	stack + 5mm
	101 series short, 10-20mm	4100-1234	Platform	MI 101	stack + 7mm
	101 series medium, 20-40mm	4100-195	Platform	MI 101	stack + 7mm
	101 series tall, 40-65mm	4100-162	Platform	MI 101	stack + 7mm
	101 series, 10-20mm, Ext X	4100-1236	Platform	MI 101	stack + 7mm
	101 series, 30-45mm, Ext X	4100-1260	Platform	MI 101	stack + 7mm
	101 series, 45-65mm, Ext X	4100-1198	Platform	MI 101	stack + 7mm
	NW 101 series			MI 101	stack + 7mm

MAGNETO-OPTIC MOUNTS


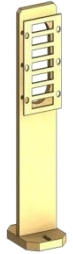

	MO support	4101-204	Platform		
	Standard flange for Magneto-Optic slide	4101-205		MI small	6
	adapter MI small	4101-241	MI 101	MI small	2
	Thin post for rotator, sample normal to field	4101-270	MI 101	Flat	6
	Thin post, sample parallel to field	4101-272		Flat	5

CASTLE MOUNTS

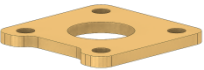
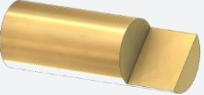

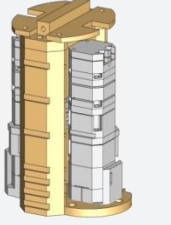
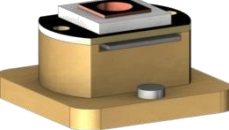
	Tall Rectangular Castle	4100-329/330/331	Platform	MI small	
--	-------------------------	------------------	----------	----------	--

Types of Sample Mounts

Last Updated: July 28, 2015

	High NA Castle	4100-517/518	Platform		
	High NA Castle	4100-514/515	MI 101		
	Round Castle	4100-SM13	Platform		

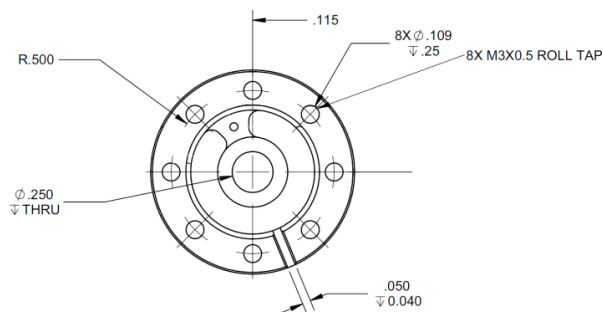
MISCELLANEOUS

	transmission plate	4200-436			1
	Post with step	4200-437	Post		
	Undamped post	4200-462	Post	MI Small	
	Dual 51 stack	4100-SM57	Platform		
	top/side pkg	4100-SM32			14

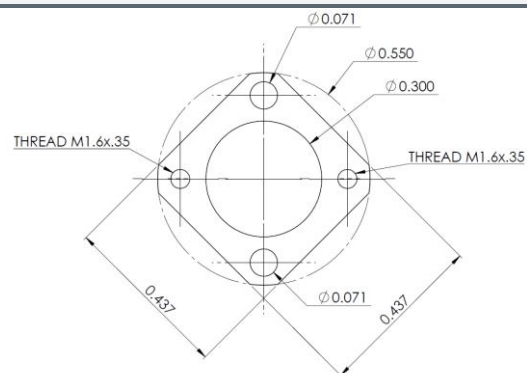
This is intended to simply show the variety of styles available, not to have the user choose the exact size or interface pattern involved. If the user is designing a custom interface, please contact Montana Instruments for help on product use. Drawings of these parts are available for end users.

*Base and top patterns are shown on the following page.

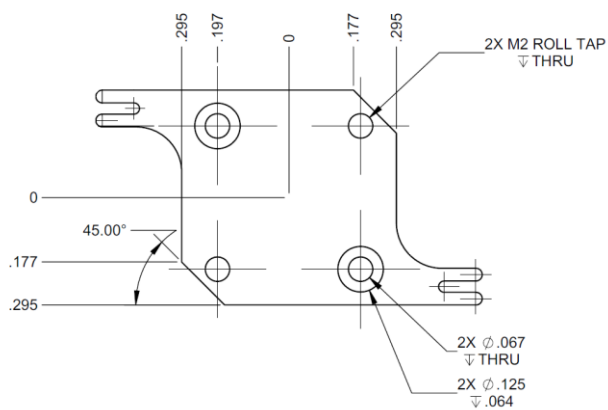
MOUNTING PATTERNS



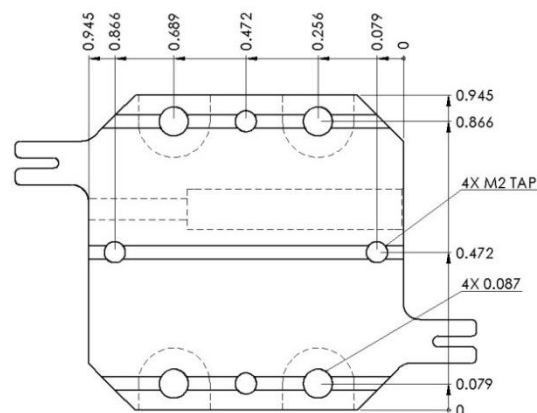
Platform



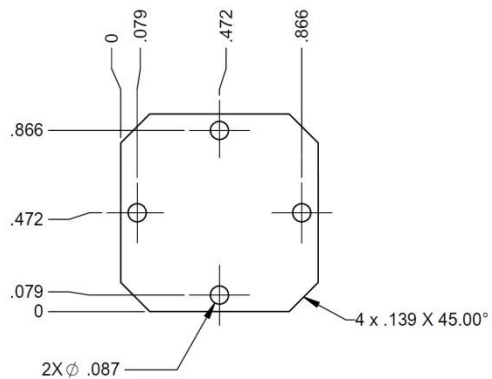
MI Main



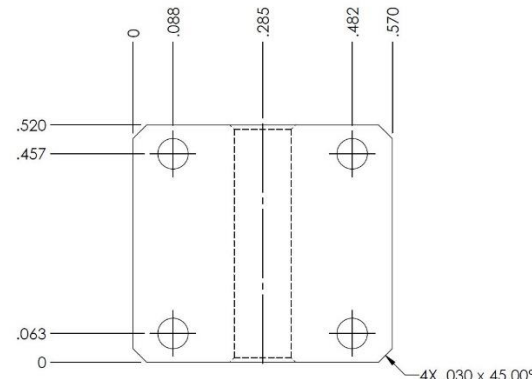
MI 51 Threaded



MI 101 Threaded



MI 101



MI Small

Note: Product specifications are based on a standard system; various options, configurations, and/or custom modifications may cause slight differences. Specifications and other information subject to change without notice.