



VSP-30
May 20, 1981

VENDOR SERVICE PUBLICATION

To: All Piper Distributors and CORPAC's

Subject: Bendix Service Bulletins 599A, 609A, 610,
613, 614

The attached publications may affect Bendix equipment installed in Piper airplanes .

Refer to each publication for identification of specific equipment affected and for detailed information regarding compliance .



**Electrical
Components
Division**

Sidney, N. Y. 13838

SERVICE BULLETIN NO. 599A
(Supersedes Service Bulletin No. 599)
Engineering Aspects are
FAA Approved

Printed June 1980
Page 1 of 3 Pages

AIRCRAFT

SUBJECT: Inspection and replacement of impulse couplings and stop pins at periodic intervals during "in service" use.

REASON FOR BULLETIN: To provide an inspection procedure to detect wear of impulse coupling components and associated stop pins. To require replacement of impulse coupling as required by inspection.

EQUIPMENT AFFECTED: All Bendix S-20, S-1200 and D-2000 series magnetos having impulse couplings.

Maintenance (Spare) Parts Affected:
None

Compliance:

1. Inspection must occur after no more than 500 operating hours and at 500 hour intervals thereafter.
2. Impulse coupling must be replaced as required by inspection.

General Information:

Impulse couplings and stop pins are subject to wear during continued use. If wear is excessive and is not detected, impulse coupling failure may occur and cause engine failure.

Removal of the magneto and inspection of the impulse coupling in accordance with this bulletin will alert operators to the described condition. Compliance with the revised instructions provided in this bulletin is intended to prevent impulse coupling failure.

Detailed Instructions:

1. Remove magneto from engine.
2. Check clearance between each impulse coupling flyweight and each stop pin as follows:

Note

Magnetos with two stop pins require four checks (each flyweight at each stop pin) and magnetos with four stop pins require eight checks.

- a. Bend the end of a stiff wire into a right angle 1/8 inch long, maximum.
- b. Position impulse coupling so that heel of flyweight (see figure 1) is adjacent to stop pin. Reach

between cam and flyweight with bent wire, as near as possible to the stop pin, and pull outward on the flyweight as shown in figure 2.

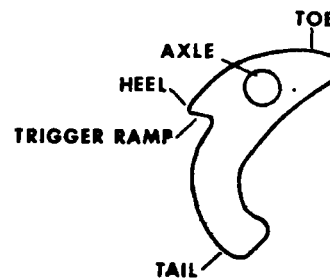

Figure 1. Terminology

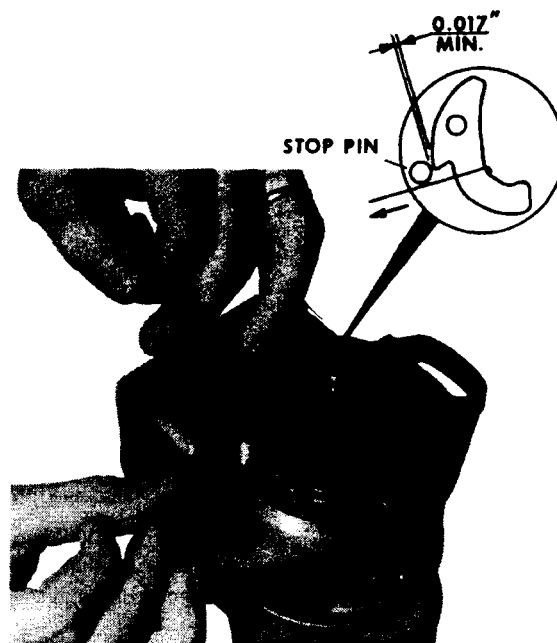

Figure 2. Checking Flyweight to Stop Pin Clearance

c. While pulling flyweight outward, insert feeler gages to measure the clearance between the heel of the flyweight and the stop pin, assuring a minimum of 0.017 inch exists.

d. If less than 0.017 inch clearance exists, this is cause for immediate rejection of the impulse coupling cam assembly, or possibly the entire impulse coupling. Refer to the applicable Magneto Overhaul Instructions for inspection procedures to determine if other impulse coupling parts are still serviceable.

CAUTION

An accurate clearance check can only be obtained by pulling the flyweight outward as described.

Note

All magnetos having the impulse coupling recessed into the magneto flange require a different procedure for holding the flyweight outward. To make a clearance check on these magnetos, use a piece of stiff wire (such as coat hanger wire) bent to an angle that can be used to push outward on the notched area of the flyweight trigger ramp section as shown in figure 3.

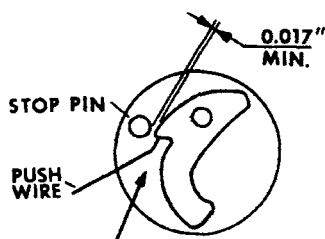

Figure 3. Checking Flyweight to Stop Pin Clearance, Recessed Impulse Coupling

e. If impulse coupling is found to be acceptable during the flyweight to stop pin clearance check, perform the additional inspection checks described in paragraphs 3 and 4.

3. The flyweight and axle wear must be checked to assure wear is within acceptable limits. The use of 11-10041 Flyweight Gage (Ref. Bendix publication L-1019, page 17) is no longer valid in view of the improved inspection procedures given in this bulletin. Perform the wear check on each flyweight as follows:

a. Rotate the impulse coupling so that the flyweight axles are adjacent to the stop pins. Pull the flyweight toward the stop pin using the same wire hook, and in the same manner as used in the preceding clearance check. (See figure 4)

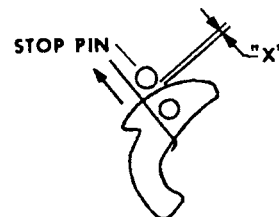

Figure 4. Flyweight/Axle Wear Check (Pull)

b. Insert feeler gages between the stop pin and flyweight to measure the clearance ("X" of figure 4) while the flyweight is held outward. Maintain constant outward pressure on the flyweight while measuring clearance to ensure an accurate clearance check is being made, and record measurement "X".

Note

The clearance measured in this check will not be the same as the clearance measured in step 2 as the flyweight is in a different position relative to the stop pin.

c. Remove the hook wire from the flyweight and insert additional feeler gages between stop pin and flyweight as required to push the flyweight directly in toward the magneto rotor shaft as far as possible. Force exerted to insert feeler gages should be limited to that required for any normal feeler gage measurement. Record the measurement obtained ("Y" of figure 5).

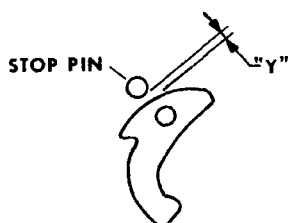

Figure 5. Flyweight/Axle Wear Check (Push)

d. Subtract measurement "X" from measurement "Y" to determine wear of flyweight and axle. If "X" - "Y" is greater than 0.016 inch, impulse coupling cam assembly must be rejected. If movement is 0.016 inch or less, flyweight and axle wear is within acceptable limits.

4. Flyweight tail condition must be given a visual examination to determine if flyweight is still serviceable. The surface at the apex of the beveled edge must blend smoothly with the outer contour of the flyweight. No flattening, denting or chipping is permissible. Any irregularity of this surface is cause for immediate rejection of the cam assembly. (See figure 6)

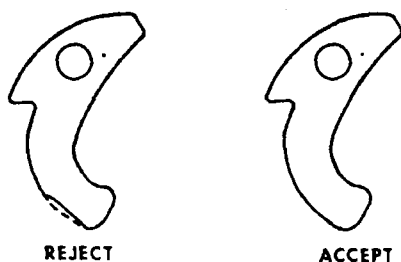

Figure 6. Flyweight Tail Condition Check

5. All magnetos with the impulse coupling recessed into the magneto flange require removal of the impulse

coupling for inspection of the flyweight tail condition. Refer to the applicable Magneto Overhaul Instructions for impulse coupling removal procedure. Disassembly of the impulse coupling for inspection may result in damage to the spring. Carefully inspect spring per the overhaul instructions, looking particularly at the ends and around spring eyes where prying may have caused nicks or scratches. Any irregularity in the spring is cause for rejection; if spring is found to be serviceable it may be reused. When impulse coupling is disassembled at magneto overhaul, spring must always be replaced.

6. If the impulse coupling is found to be unacceptable as a result of any of the preceding checks described, replace the entire impulse coupling assembly or worn parts according to instructions of applicable Bendix publications.
7. When inspection of the impulse coupling assembly is being performed, the stop pins in the magneto flange or housing must also be examined. Visible damage or wear in the area where the flyweight contacts the stop pin is cause for repair or replacement of the magneto, stop pin, housing or flange depending on magneto. (Reference latest revision of Bendix Overhaul Manuals Publication Forms L-205, L-645, L-945 and L-1019.)
8. When inspection procedures outlined in this bulletin have been completed, an appropriate notation must be made in the Engine Log Book referencing magneto serial number.

Parts Required:
As determined by inspection.

Special Tools Required:
None

Man Hours Required:
Approximately 1 hour.

Weight Change:
None



▶ AIRCRAFT

SUBJECT: Inspection of Internal timing, S-1200 Remanufactured (Blue Label) Magnetos.

REASON FOR BULLETIN: To alert users of a possible problem and provide an inspection procedure for detection.

EQUIPMENT AFFECTED: Remanufactured (Blue Label) magnetos with serial numbers 801001 through 942001.

SPARE PARTS AFFECTED:
Refer to Equipment Affected.

COMPLIANCE:
All S-1200 Series magnetos listed in "Equipment Affected" should be inspected upon receipt of this Bulletin.

GENERAL INFORMATION:
Field reports indicate that a quantity of remanufactured S-1200 magnetos have been discovered with the large distributor gear mistimed. To avoid damage to the distributor block and resultant ignition difficulty, the magnetos involved should be examined according to the applicable inspection method listed below.

DETAILED INSTRUCTIONS:
Inspection Method "A" with magneto on engine.

1. Remove plug from top of magneto housing and plug at bottom of housing on 4 and 6 cylinder magnetos. On 8 cylinder magnetos, remove top plug and which ever side plug is most accessible.

NOTE

With engine in the No. 1 firing position the timing marks on the gear, distributor block and the rotor must be clearly visible through the open plug holes. If this cannot be accomplished, it will be necessary to remove the magneto from the engine and utilize INSPECTION METHOD "B". If the timing marks can be clearly seen, follow procedure described in paragraphs 2 through 7.

2. For magnetos which do not have an impulse coupling proceed as follows:

WARNING

Place Ignition Switch In "Off" Position.

- a. Turn engine in direction of normal rotation toward the firing position of No. 1 cylinder on the compression stroke. As this point is approached the timing ribs or marks on the rotating magnet should begin to appear in the open viewing hole.
- b. Continue turning the engine slowly, still in the direction of normal rotation, until the proper timing mark on the rotating magnet is centered in the viewing hole. Figure 1 illustrates the timing mark centered for a right hand rotation magneto. A left hand rotation magneto would have the left hand mark centered. Eight cylinder magnetos will show an "R" line or an "L" line on the rotating magnet through the viewing hole.

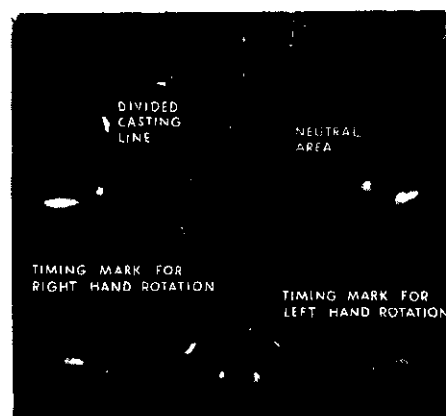

Figure 1. Alignment of Magnet Marks —
Right Hand Rotation



3. For magnetos having an impulse coupling proceed as follows:

WARNING

Place Ignition Switch In "Off" Position

- a. Turn engine in direction of normal rotation past TDC firing position until impulse coupling "clicks."
 - b. Turn engine in opposite direction slightly past the TDC firing position.
 - c. Turn engine slowly back toward number one cylinder firing position until proper timing mark on magnet is in center of the viewing hole (See figure 1).
4. Check at top timing hole in magneto to determine if proper mark on distributor gear aligns with timing rib on distributor block. Alignment tolerances are as follows:
- a. "4" and "8" Cylinder, all types – The timing rib on the distributor block MUST align within 1/2 tooth either side of the "L" or "R" mark on the gear, depending on magneto rotation. (See figure 2)

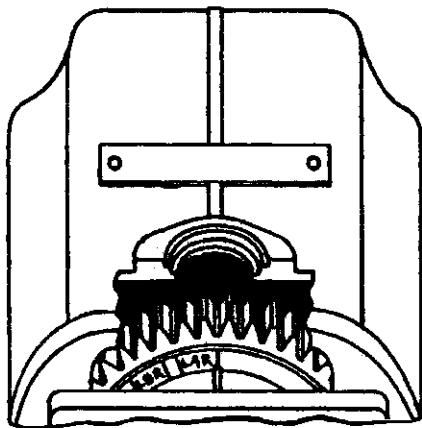

Figure 2. Alignment of Timing Marks on Distributor Gear – 4 Cylinder, Right Hand Rotation

- b. "6" Cylinder, single breaker types – The timing rib on the distributor block MUST lie between the "L" and "LB" or the "R" and "RB" marks on the gear, and should be nearer to the "L" or "R" mark, depending on magneto rotation. (See figure 3)

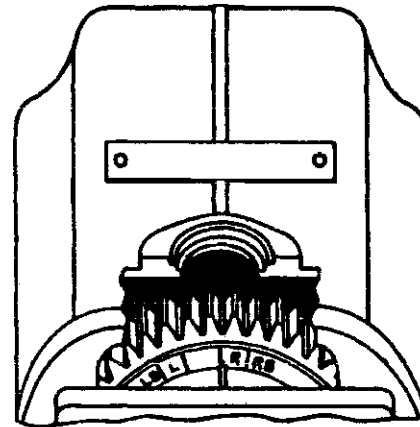

Figure 3. Alignment of Timing Marks on Distributor Gear – 6 Cylinder, Single Breaker, Right Hand Rotation

- c. "6" Cylinder, retard breaker types – The timing rib on distributor block MUST lie between the "L" and "LB" or the "R" and "RB" marks on the gear, and should be nearer to the "LB" or "RB" mark, depending on magneto rotation. (See figure 4)

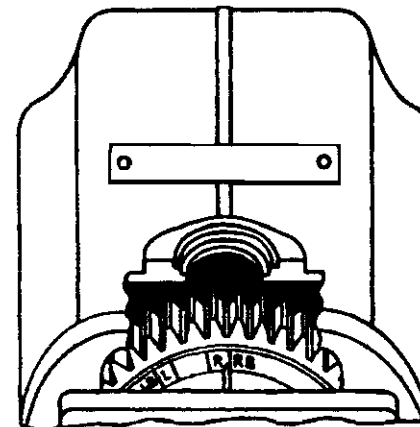

Figure 4. Alignment of Timing Mark on Distributor Gear – 6 Cylinder, Retard Breaker, Right Hand Rotation

5. If timing marks align, the magneto is internally timed correctly.
6. When procedures have been completed, compliance with this Service Bulletin should be indicated as follows:

- a. An appropriate Engine Log Book entry must be made.
- b. The magneto must be identified by painting a white dot approximately 1/4 inch in diameter on the magneto housing at the location indicated in figure 5.

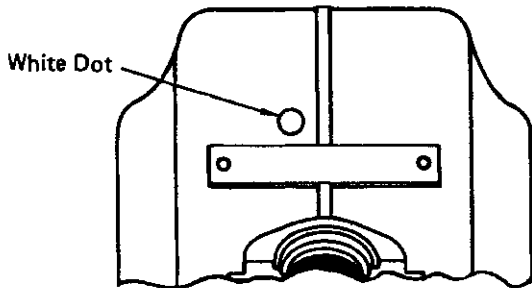

Figure 5. Typical identification mark location.

7. If timing marks are not aligned remove magneto from engine and follow instructions in Method "B".

Inspection Method "B" with magneto removed from engine.

1. Position timing mark on rotating magnet in center of viewing hole.
2. Check marks on distributor gear at top timing hole as described in Method "A" paragraphs 4 and 5.
3. If timing is incorrect remove gear from distributor block and inspect inside of block for carbon tracking or burning. If either of these conditions is noted, replace the distributor block. If block is satisfactory it may be reinstalled.
4. Correct internal timing of magneto as described in paragraph 2-55 through 2-60 of S-1200 Overhaul Manual,

Bendix publication form L-645.

5. Reinstall magneto on engine as described in Bendix Installation and Maintenance form L-609, paragraphs 3-2 through 3-5.
6. When procedures have been completed, compliance with this Service Bulletin should be indicated as follows:
 - a. An appropriate Engine Log Book entry must be made.
 - b. The magnetos must be identified by painting a white dot approximately 1/4 inch in diameter on the magneto housing at the location indicated in figure 5.

Compensation for the work and replacement parts involved in complying with this Service Bulletin will be made upon the submission of a Warranty Claim submitted through a currently Authorized Bendix Electrical Components Division Distributor. Compensation will be made in accordance with established Bendix Warranty procedures.

Authorized Distributors are listed in Bendix Publication, form L-606 contained in the Bendix Electrical Components Aircraft Master Manual.

Special Tools Required:

Refer to Bendix Overhaul publication form L-645.

Man Hours Required:

Will vary with Aircraft Installation and Inspection Method used.

Weight Change:

None



AIRCRAFT

SUBJECT: 10-682014 and 10-682016 Insulated Distributor Gear Kits For D-2000/D-2200 Series Magnetos.

REASON FOR BULLETIN: To announce availability of an improved insulated distributor gear (kit) for the subject magnetos.

EQUIPMENT AFFECTED: All D-2000/D-2200 Series Magnetos.

Spare Parts Affected:

Distributor gears and related parts for units listed in "Equipment Affected."

Compliance:

At users discretion or at next magneto overhaul.

General Information:

This bulletin announces availability of an improved, insulated distributor gear in kit form which is interchangeable between the D-2000/D-2200 & D-3000/D-3200 series magnetos. The kit includes all parts (except distributor block) as identified in figure 1.

Identification of the gear kit part number is defined in Table 1.

TABLE 1

GEAR TYPE	KIT P/N
4 cyl.	10-682014
6 cyl.	10-682016
8 cyl.	10-682014

Assembly sequence of the gear kit to distributor block is shown in Figure 1.

CAUTION

When timing magneto on bench or when re-installing magneto on engine, no gear holding timing device should be used as hidden gear tooth damage may result.

Parts Required per Magneto:

- 2 kits 10-682014 4 cylinder
- 2 kits 10-682016 6 cylinder
- 2 kits 10-682014 8 cylinder

Special Tools Required:

- 11-3071* Retaining Ring Pliers

Man Hours Required:

Not Applicable

*May be obtained from Electrical Components Division or TRU-ARC Division, Waldes-Kohinoor, Inc., Long Island City, NY 11101. TRU-ARC Retaining Ring Pliers No. 2

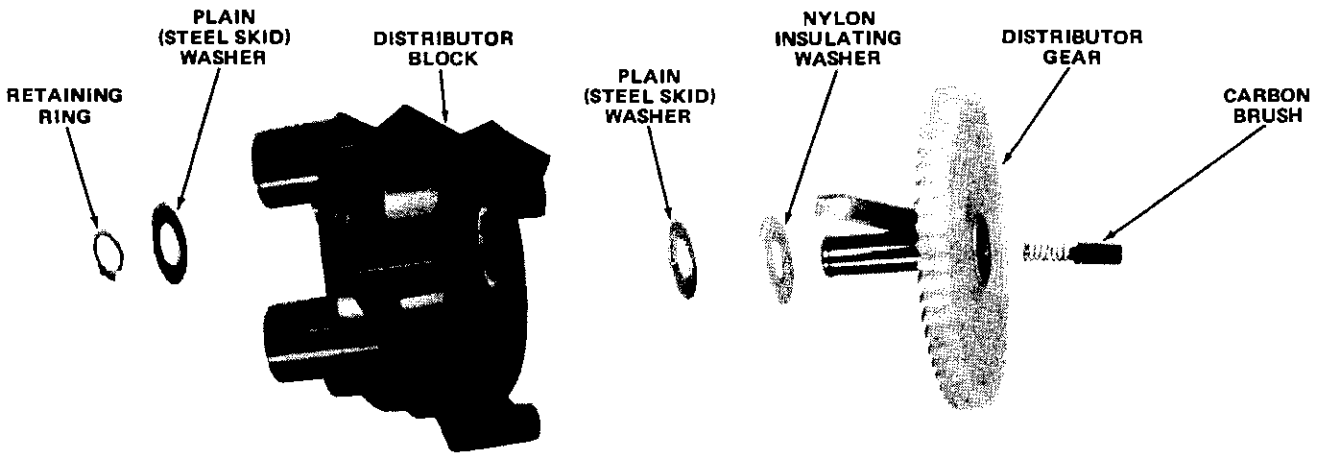

Figure 1.



Engine Products Division

Sidney, N. Y. 13838

SERVICE BULLETIN NO. 613
Engineering Aspects are
FAA Approved

Printed April 1981
Page 1 of 5 Pages

AIRCRAFT

SUBJECT: Inspection and / or replacement of green distributor blocks in S-1200 Series Magnetos.

REASON FOR BULLETIN:

1. To announce the availability of an improved Diallyl Phthalate (DAP) green distributor block incorporating a new design "Gripper" oilite bushing.
2. To alert users of a possible loose oilite bushing in the original green DAP distributor block. Field reports indicate that the bronze oilite bushing in the current green distributor block may become loose and turn within the block. This condition could wear the block enough to cause the distributor gear to become mistimed resulting in rough engine operation.
3. To provide instructions for inspection and/or replacement of the original green distributor blocks with the new "Gripper Bushing" green distributor blocks as required.

EQUIPMENT AFFECTED:

1. All S-1200 Series Magnetos below serial number A279075 (red label) or 8114001 (blue label) with factory installed green distributor blocks and identified as P/N 10-349xxx-xxD but without the letter "R" stamped on the identification plate as indicated in figure 7 of this Service Bulletin.

Note: "D" after the part number indicates the magneto has a green DAP distributor block.

2. All S-1200 Series Magnetos with field installed green DAP distributor blocks. (Ref. Bendix Service Bulletin No. 573) without the letter "R" stamped on the identification plate as indicated in figure 7 of this Service Bulletin.
3. All S-1200 Series green distributor blocks not identified as indicated in figure 1 of this Service Bulletin.
4. All green distributor blocks and block kits identified in Maintenance (Spare) Parts Affected.

Maintenance (Spare) Parts Affected:

Block	Block Kit	
10-391331	10-391424	4 cylinder
10-391319	10-391426	6 cylinder
10-391361	10-391428	8 cylinder

2. All magnetos having a green distributor block with 1000 or more operating hours must have this block inspected (or replaced at owner's option) per the instructions in this Service Bulletin at the next regularly scheduled inspection period. This block must be replaced at the next magneto overhaul or engine overhaul, whichever occurs first.

Compliance:

1. All magnetos having a green distributor block with less than 1000 operating hours must have this block replaced with the new "Gripper Bushing" block within the next 25 operating hours or at the next regularly scheduled inspection, whichever occurs first.

General Information :

The new "Gripper Bushing" will eliminate the possibility of the bushing becoming loose. The "Gripper Bushing" block can be identified by a circular shaped mark 0.188 inch \pm 0.031 inch in diameter raised 0.010 inch to 0.030 inch above the surface of the block. This mark is located on the tower side of the block, as indicated in figure 1.

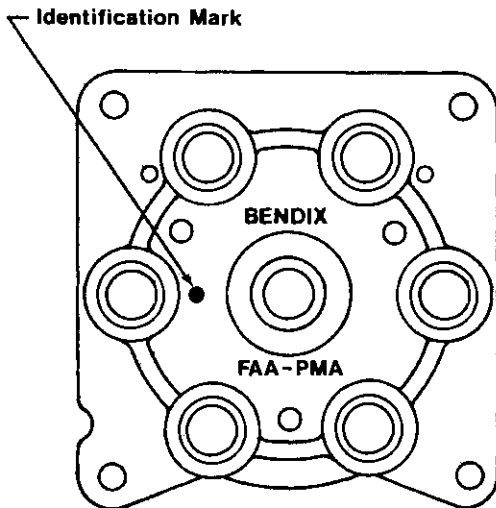

Figure 1. Location of Identification Mark

Detailed Instructions :

Distributor Block Inspection

Inspect affected S-1200 magnetos to determine if the distributor gear bearing is loose in the green distributor block as follows :

Note

Inspection of the distributor block may be performed with the magneto on the engine if accessibility permits. Otherwise, remove the magneto from the engine for the required inspection.

1. Remove the harness plate and the top timing plug from the magneto.
2. Remove the retaining ring P/N 10-92815-37 from the end of the distributor gear axle and discard.
3. Remove steel washer P/N 10-349511 and felt washer P/N 10-50752 from the gear axle.
4. Fabricate a probe of 1/4 inch round, non-metallic material, preferably wood dowel rod, approximately six inches long. The probe should be tapered at one

end to resemble a screw driver blade with a tip size approximately 1/16 inch thick and 1/4 inch wide.

CAUTION

Avoid using excessive force or prying with the fabricated probe. Excessive force could cause damage to the gear teeth or could result in breaking off a piece of the probe inside the magneto. Either condition would require complete disassembly of the magneto for repair.

5. Insert the formed end of the fabricated probe through the timing inspection hole in the magneto housing and between two teeth of the distributor gear. Using moderate force, so as not to damage the gear teeth, attempt to push the gear back and forth sideways while observing the bronze bearing in the distributor block.
6. If no looseness is detected, reassemble the magneto by reinstalling felt washer P/N 10-50752 and steel washer 10-349511 and installing a new retaining ring P/N 10-92815-37. Reinstall the magneto harness plate and the timing plug in the magneto housing.
7. If a loose distributor gear bearing is detected, replace the green block with the new "Gripper Bushing" block following procedures given in this bulletin.

Distributor Block Replacement

Note

If accessibility permits, replacement of the distributor block may be performed with the magneto on the engine.

Procedure for on engine replacement.

WARNING

Ignition switch must be in the OFF position while performing any procedures on the engine.

1. Remove the four harness retainer plate nuts, P/N 10-92873-302, and lockwashers, P/N 10-92879-43. If the magneto is pressurized, remove the packing O-ring P/N 10-90351-9 under each lock washer. Now slide the harness away from the magneto.



2. Remove the cover retaining screw and lock washer P/N 10-35937-24. If the unit is pressurized, remove the additional washer, P/N 10-55501. If necessary for cover removal, disconnect the ignition P-lead from the capacitor terminal. Carefully slide the cover off of the four distributor block securing studs and disconnect the capacitor lead flag terminal from the contact assembly post.
3. Remove the timing plug, or if a pressurized magneto, disconnect the pressure line and remove the threaded bushing from the top of the housing. On 4 and 6 cylinder magnetos, remove the side plug which is most accessible.

Note

With the engine in the No. 1 firing position, the timing marks on the distributor block and the rotor must be clearly visible through the open plug holes. If this is not possible, the magneto must be removed from the engine to replace the block and retime the magneto.

4. For magnetos which do not have an impulse coupling, proceed as follows:
 - a. Turn the engine in direction of rotation toward the firing position of the No. 1 cylinder on the compression stroke. As this point is approached, the timing ribs or marks on the rotating magnet should begin to appear in the open viewing hole.
 - b. Continue turning the engine slowly, still in the direction of normal rotation, until the proper timing mark on the rotating magnet is centered in the viewing hole. Figure 2 illustrates the timing mark centered for a right hand rotation magneto. A left hand rotation magneto would have the left hand mark centered. (See figure 2.) Eight cylinder magnetos will show an "R" line or an "L" line on the rotating magnet.
5. For magnetos with an impulse coupling proceed as follows:
 - a. Turn engine in direction of normal rotation past TDC firing position until impulse coupling "clicks".
 - b. Turn engine in opposite direction slightly past TDC firing position.
 - c. Turn engine slowly back toward normal number

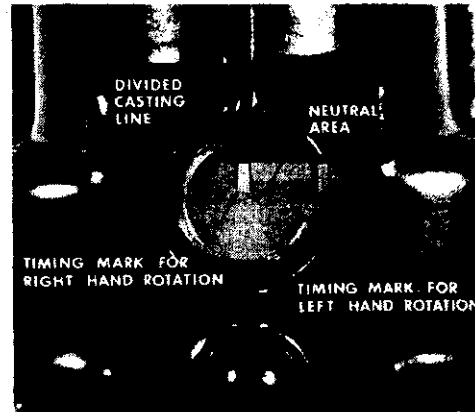

Figure 2. Alignment of Magnet Marks — Right Hand Rotation

one cylinder firing position until proper timing mark on rotating magnet is in the center of the viewing hole. (See figure 2.)

6. Check at top timing hole in magneto to determine if the proper mark on the distributor gear aligns with the timing rib on the distributor block. Alignment tolerances are as follows:
 - a. Four and eight cylinder, all types — The timing rib on the distributor block **MUST** align within 1/2 tooth either side of the "L" or "R" mark on the gear, depending on magneto rotation. (See figure 3.)

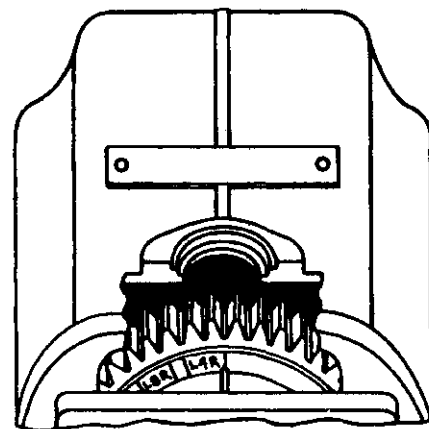

Figure 3. Alignment of Timing Marks on Distributor Gear — 4 Cylinder, Right Hand Rotation



b. Six cylinder, single breaker types – The timing rib on the distributor block MUST lie between the "L" and "LB" or the "R" and "RB" marks on the gear, and should be nearer to the "L" or "R" mark, depending on magneto rotation. See figure 4.

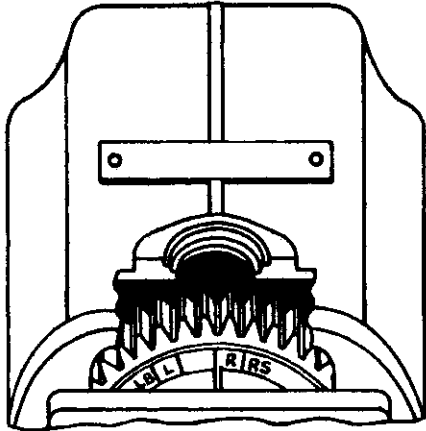

Figure 4. Alignment of Timing Marks on Distributor Gear – 6 Cylinder, Single Breaker, Right Hand Rotation

c. Six cylinder, retard breaker types – The timing rib on the distributor block MUST lie between the "L" and "LB" or the "R" and "RB" marks on the gear, and should be nearer to the "LB" or "RB" mark, depending on magneto rotation. (See figure 5.)

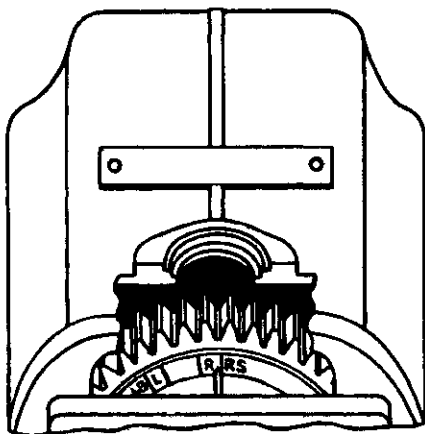

Figure 5. Alignment of Timing Marks on Distributor Gear – 6 Cylinder, Retard Breaker. Right Hand Rotation

7. Once proper timing mark alignment is obtained, continue the disassembly process as follows:

a. Remove the four distributor block retaining studs, P/N 10-349221.

b. Slide the distributor block and gear assembly out of the magneto housing.

c. Separate gear assembly from distributor block by removing and discarding gear axle retaining ring, P/N 10-92816-37, then sliding the gear out of the block bore.

d. Remove the felt washer, P/N 10-50752 from the "old" block and discard the block.

e. Wipe all oil off the gear assembly axle, the nylon washer, P/N 10-391309, and the two steel washers, P/N 10-349511. Wipe all excess grease from the faces of the gear, leaving a thin coating of grease on the gear teeth only.

f. Inspect all parts for excessive wear and replace parts as necessary.

B. For reassembly, reference figure 6 and proceed as follows:

a. Place gear assembly on a clean cloth on a flat surface, with the gear axle upward.

b. Slide the nylon washer, P/N 10-391309, then one steel washer, P/N 10-349511 onto the gear axle.

c. Insure that the gear axle and surrounding area is free of any lubricant and foreign particles.

Note

It is no longer necessary to lubricate the gear axle during assembly, as the distributor block bushing is impregnated with a lubricant during the manufacturing process.

d. Remove the "Gripper Bushing" distributor block and re-lubricate if necessary with Bendix Distributor Block Lubricant, P/N 10-391200.

e. Install the felt washer, P/N 10-50752, in the block and re-lubricate if necessary with Bendix Distributor Block Lubricant, P/N 10-391200.

f. Place the second steel washer, P/N 10-349511, onto the gear axle.

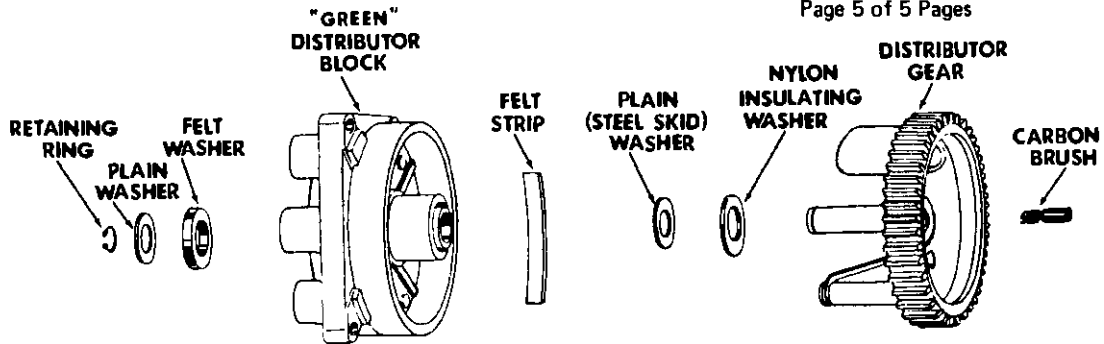

Figure 6. Distributor Gear/Block Exploded View

g. Complete the gear and block assembly by installing a new retaining ring, P/N 10-92B15-37, onto the end of the gear axle.

h. For assembly of the magneto and setting the internal timing, refer to Bendix Publication L-645-1 Overhaul Manual.

block must be replaced with the "Gripper Bushing" block as directed in this Service Bulletin. At that time the letter "R" must be stamped over the letter "I" to indicate the block has been replaced.

Procedure for Off Engine Replacement

If it is impossible to remove and replace the distributor block with the magneto mounted on the engine, proceed as follows:

1. Remove the magneto from the engine.
2. Comply with paragraphs 1 through 8 of Distributor Block Inspection in the Detailed Instructions of this bulletin.
3. Refer to Bendix Publication L-609-3 Installation, Operation and Maintenance, Paragraphs 3-2 through 3-5 for reinstalling magneto on engine.

Identification

When procedures have been completed, compliance with this Service Bulletin should be indicated as follows:

1. An appropriate Engine Log Book entry must be made, referencing magneto serial number.
2. Magnetos in which the block has been replaced must be identified by stamping the letter "R" in the lower left corner of the identification plate, below the drive screw securing the plate to the housing (See figure 7).
3. Magnetos in which the block has been inspected, but not replaced, must be identified by stamping the letter "I" in the location indicated in figure 7.

Note

At engine overhaul or magneto overhaul the



Figure 7. Location of Identification Letter(s) on Identification Plate

Warranty Coverage

S-1200 Series Magnetos with 1000 hours or less of accumulated operating time and having been in service one year or less, will have full warranty coverage.

Compensation

Compensation for the work involved in complying with this Service Bulletin for those magnetos under warranty will be made upon submission of a Warranty Claim submitted through a currently Authorized Bendix Engine Products Division Distributor. Compensation will be made in accordance with established Bendix Warranty procedures.

Authorized Distributors are listed in Bendix Publication L-606, available at no charge by request to the Bendix Corporation, Engine Products Division, Sidney, N.Y. 13838.

Special Tools Required:

Refer to Bendix Publication L-645-1 Overhaul Manual.

Man Hours Required:

1.5 hours per magneto on engine
0.5 hour per magneto on shelf

Weight Change:

None