



evolution wireless G4 100 P series

Instruction Manual

Sennheiser electronic GmbH & Co. KG

SENNHEISER

Am Labor 1, 30900 Wedemark, Germany, www.sennheiser.com
ew 100 P G4 - v2.0



Overview 6

ew 100 P G4 series products 7

- EK 100 G4 diversity receiver 8
- SKM 100 G4 handheld transmitter 9
- SK 100 G4 bodypack transmitter 10
- SKP 100 G4 plug-on transmitter 11

Accessories 12

- Microphones and cables 13
 - Microphone modules 13
 - Headset and Lavalier microphones 13
 - Line connecting cable 15
- Rechargeable battery and charger 16
 - BA 2015 rechargeable battery 16
 - L 2015 charger 16
- Accessories for camera mounting 17
 - CA 2 camera adapter 17
- Additional accessories 18
 - Color labeling set 18
 - Microphone clamp 18

The frequency bank system 19

Installing ew 100 P G4 series devices 20

Installing the EK 100 G4 21

- Inserting and removing the batteries/rechargeable batteries 21
 - Battery status 22
- Attaching the diversity receiver to a camera 23
- Connecting the diversity receiver to a camera 26

Installing the SKM 100 G4 28

- Inserting and removing the batteries/rechargeable batteries 29
 - Battery status 30
- Replacing the microphone module 31
- Changing the colored ring 32

Installing the SK 100 G4 33

- Inserting and removing the batteries/rechargeable batteries 34
 - Battery status 35
- Connecting a microphone to the SK 100 G4 36
- Connecting an instrument or line source to the SK 100 G4 37
- Attaching the bodypack transmitter to clothing 38

Installing the SKP 100 G4 39

- Inserting and removing the batteries/rechargeable batteries 40
 - Battery status 41
- Attaching the plug-on transmitter to the microphone 42

Using ew 100 P G4 series devices 43

Using the EK 100 G4 45

- Operating elements of the EK 100 G4 diversity receiver 46



- Switching the EK 100 G4 on and off 47
- Lock-off function 48
- Displays on the EK 100 G4 display panel 49
- Buttons for navigating through the menu 50
- Home screen 52
 - Frequency/Name** standard display 52
 - Frequency Bank/Channel/Name** standard display 53
- Setting options in the menu 54
- Menu structure 55
- Sync menu item 56
- Squelch menu item 57
- Easy Setup menu item 59
- Frequency Preset menu item 61
- Name menu item 62
- AF Out menu item 63
- Auto Lock menu item 64
- Advanced menu item 65
- Advanced -> Tune menu item 66
 - Only adjusting the frequency 66
 - Setting the channel and frequency 66
- Advanced -> Pilot Tone menu item 66
- Advanced -> LCD Contrast menu item 67
- Advanced -> Reset menu item 67
- Advanced -> Software Revision menu item 67

Using the SKM 100 G4 68

- Operating elements of the SKM 100 G4 handheld transmitter 69
- Switching the SKM 100 G4 handheld transmitter on and off 70
- Muting the handheld transmitter (AF mute) 71
 - SKM 100 G4 71
 - SKM 100 G4-S 71
- Deactivating the RF signal (RF mute) 72
- Lock-off function 73
- Displays on the SKM 100 G4 handheld transmitter display panel 74
 - Select a standard display 75
- Buttons for navigating the SKM 100 G4 menu 76
 - Navigating through the menu 76
 - Making changes in a menu item 76
- Setting options in the menu 77
- Sensitivity menu item 78
- Frequency Preset menu item 79
- Name menu item 79
- Auto Lock menu item 80
- Advanced menu item 81
- Advanced > Tune menu item 82
 - Only adjusting the frequency 82
 - Setting the channel and frequency 82
- Advanced > Mute Mode menu item (SKM 100 G4-S only) 83
- Advanced > Pilot Tone menu item 83



- Advanced > LCD Contrast menu item 83
- Advanced > Reset menu item 84
- Advanced > Software Revision menu item 84

Using the SK 100 G4 85

- Operating elements of the SK 100 G4 bodypack transmitter 86
- Switching the SK 100 G4 bodypack transmitter on and off 87
- Muting the bodypack transmitter (AF mute) 88
- Deactivating the RF signal (RF mute) 89
 - Deactivating the RF signal with the **MUTE** switch 89
 - Deactivating the RF signal with the **ON/OFF** button 91
- Lock-off function 92
- Displays on the SK 100 G4 bodypack transmitter display panel 93
 - Select a standard display 94
- Buttons for navigating the SK 100 G4 menu 95
 - Navigating through the menu 95
 - Making changes in a menu item 95
- Setting options in the menu 96
- Sensitivity menu item 97
- Frequency Preset menu item 97
- Name menu item 98
- Auto Lock menu item 98
- Advanced menu item 99
- Advanced > Tune menu item 100
 - Only adjusting the frequency 100
 - Setting the channel and frequency 100
- Advanced > Mute Mode menu item 101
- Advanced > Cable Emulation menu item 101
- Advanced > Pilot Tone menu item 102
- Advanced > LCD Contrast menu item 102
- Advanced > Reset menu item 102
- Advanced > Software Revision menu item 102

Using the SKP 100 G4 103

- Operating elements of the SKP 100 G4 plug-on transmitter 104
- Switching the SKP 100 G4 plug-on transmitter on and off 105
- Muting the plug-on transmitter (AF mute) 106
- Deactivating the RF signal (RF mute) 107
 - Deactivating the RF signal with the **MUTE** switch 107
 - Deactivating the RF signal with the **ON/OFF** button 108
- Lock-off function 109
- Displays on the SKP 100 G4 plug-on transmitter display panel 110
 - Select a standard display 111
- Buttons for navigating the SKP 100 G4 menu 112
 - Navigating through the menu 112
 - Making changes in a menu item 112
- Setting options in the menu 113



- Sensitivity menu item 114
- Frequency Preset menu item 114
- Name menu item 115
- Auto Lock menu item 115
- Advanced menu item 116
- Advanced > Tune menu item 117
 - Only adjusting the frequency 117
 - Setting the channel and frequency 117
- Advanced > Mute Mode menu item 118
- Advanced > Pilot Tone menu item 118
- Advanced > LCD Contrast menu item 118
- Advanced > Reset menu item 119
- Advanced > Software Revision menu item 119

Establishing a radio link 120

- Setting notes 120

Synchronizing devices 121

Overview 122

Product variants 123

- EK 100 G4 product variants 123
 - Made in Germany 123
 - Assembled in the USA 123
- SKM 100 G4 product variants 124
 - Made in Germany 124
 - Assembled in the USA 124
- SK 100 G4 product variants 125
 - Made in Germany 125
 - Assembled in the USA 125
- SKP 100 G4 product variants 126
 - Made in Germany 126
 - Assembled in the USA 126

Frequency tables 127

Specifications 128

- EK 100 G4 129
 - RF characteristics 129
 - AF characteristics 130
 - Overall device 130
- SKM 100 G4 131
 - RF characteristics 131
 - AF characteristics 131
 - Overall device 132
- SK 100 G4 133
 - RF characteristics 133
 - AF characteristics 133
 - Overall device 134
- SKP 100 G4 135
 - RF characteristics 135
 - AF characteristics 136
 - Overall device 136

Pin assignment 137

- 3.5 mm stereo jack plug 137



3.5 mm mic jack plug 137

3.5 mm line jack plug 137

6.3 mm stereo jack plug, balanced (audio in/loop out)
137

6.3 mm mono jack plug, unbalanced 138

6.3 mm stereo jack plug for headphone jack 138

XLR-3 plug, balanced 138

Hollow jack plug for power supply 138

Cleaning and maintenance 139

Cleaning the sound inlet basket of the microphone module 139



PRODUCT INFORMATION

Overview

You can find information about the individual products in the ew 100 P G4 series under “ew 100 P G4 series products”.

For information about the available accessories, see “Accessories”.

You can find information about the ew 100 P G4 series frequency bank system under “The frequency bank system”.





ew 100 P G4 series products



You can also find more information here:

- A variety of **frequency variants** are available from the individual products. You can find more information under “Product variants”.
 - You can find **technical specifications** about the individual products under “Specifications”.
 - You can find information about **installing** the products under “Installing ew 100 P G4 series devices”.
 - You can find information about **operating** the products under “Using ew 100 P G4 series devices”.
-



EK 100 G4 diversity receiver



i You can find more detailed information about the EK 100 G4 in the following sections:

- **Installation and Startup:** “Installing the EK 100 G4”
 - **Operation:** “Using the EK 100 G4”
 - **Technical Data:** “EK 100 G4”
-



SKM 100 G4 handheld transmitter



SKM 100 G4 variant:



SKM 100 G4-S variant:



The SKM 100 G4 handheld transmitter is also available in the SKM 100 G4-S variant with an integrated mute switch.



You can find more detailed information about the SKM 100 G4 in the following sections:

- **Installation and Startup:** “Installing the SKM 100 G4”
- **Operation:** “Using the SKM 100 G4”
- **Technical Data:** “SKM 100 G4”



SK 100 G4 bodypack transmitter



i You can find more detailed information about the SK 100 G4 in the following sections:

- **Installation and Startup:** “Installing the SK 100 G4”
 - **Operation:** “Using the SK 100 G4”
 - **Technical Data:** “SK 100 G4”
-



SKP 100 G4 plug-on transmitter



i You can find more detailed information about the SKP 100 G4 in the following sections:

- **Installation and Startup:** “Installing the SKP 100 G4”
 - **Operation:** “Using the SKP 100 G4”
 - **Technical Data:** “SKP 100 G4”
-



Accessories

A variety of accessories are available for the ew 100 P G4 series.



Microphones and cables

Microphone modules

We recommend using the following microphone modules with the SKM 100 G4 and SKM 100 G4-S handheld transmitters.

Module	Features	Article no.
MMD 835-1 BK	Dynamic, cardioid, black	502575
MMD 845-1 BK	Dynamic, super-cardioid, black	502576
MME 865-1 BK	Capacitor, super-cardioid, black	502581
MMD 935-1 BK	Dynamic, cardioid, black	502577
MMD 945-1 BK	Dynamic, super-cardioid, black	502579
MMK 965-1 BK	Capacitor, switchable Cardioid/super-cardioid, black	502582
MMK 965-1 NI	Capacitor, switchable Cardioid/super-cardioid, nickel	502584
MMD 42-1	Dynamic, omni-directional, black	506772

i You can find more information about the individual microphone modules on their respective product pages at www.sennheiser.com.

Headset and Lavalier microphones

We recommend using the following Lavalier microphones and headset microphones with the SK 100 G4 bodypack transmitter.

Microphone	Features	Article no.
ME 2-II	Lavalier microphone, omni-directional, black	507437
ME 3-II	Headset microphone, cardioid, black	506295
ME 4-N	Lavalier microphone, cardioid, black	005020
MKE 1-ew	Lavalier microphone, omni-directional, black	502876
MKE 1-ew-3	Lavalier microphone, omni-directional, beige	502879
MKE 2-ew Gold	Lavalier microphone, omni-directional, black	009831
MKE 2 ew-3 Gold	Lavalier microphone, omni-directional, beige	009832
MKE 40-ew	Lavalier microphone, cardioid, black	500527



Microphone	Features	Article no.
SL Headmic 1 BE	Headband microphone, omni-directional, beige	506272
SL Headmic 1 BK	Headband microphone, omni-directional, black	506271
SL Headmic 1 SB	Headband microphone, omni-directional, silver	506904

 You can find more information about the individual microphones on their respective product pages at www.sennheiser.com.



Line connecting cable

The following cables can be used to connect cameras to the EK 100 G4 diversity receiver:

- **CL 1**
3.5 mm jack plug on lockable 3.5 mm jack plugs
Article no. 005022



- **CL 100**
XLR-3 on a 3.5 mm jack plug
Article no. 087046





Rechargeable battery and charger

BA 2015 rechargeable battery

The BA 2015 rechargeable battery is designed for use with evolution wireless G4 series handheld transmitters, bodypack transmitters and bodypack receivers.

Article no. 009950



L 2015 charger

The BA 2015 rechargeable battery can be charged in the L 2015 charger on its own or inside of the bodypack transmitter/bodypack receiver.

Article no. 009828





Accessories for camera mounting

CA 2 camera adapter

Camera adapter with hot shoe for portable bodypack transmitters/receivers from the ew G1, G2, G3 and G4 series.

Article no. 009986





Additional accessories

Color labeling set

- **KEN 2**, color labeling set for SKM handheld transmitters
Article no. 530195



Microphone clamp

- **MZQ 1**, microphone clamp for SKM handheld transmitters
Article no. 076670





The frequency bank system

There are different frequency ranges in the UHF band available for transmission.

The following frequency ranges are available for the **ew 100 G4** series:

- **A1 range:** 470 – 516 MHz
- **A range:** 516 – 558 MHz
- **AS range:** 520 – 558 MHz
- **G range:** 566 – 608 MHz
- **GB range:** 606 – 648 MHz
- **B range:** 626 – 668 MHz
- **C range:** 734 – 776 MHz
- **D range:** 780 – 822 MHz
- **TH range:** 794 – 806 MHz
- **JB range:** 806 – 810 MHz
- **E range:** 823 – 865 MHz
- **K+ range:** 925 – 937.5 MHz

Every frequency range has **21 frequency banks** with up to 12 channels:

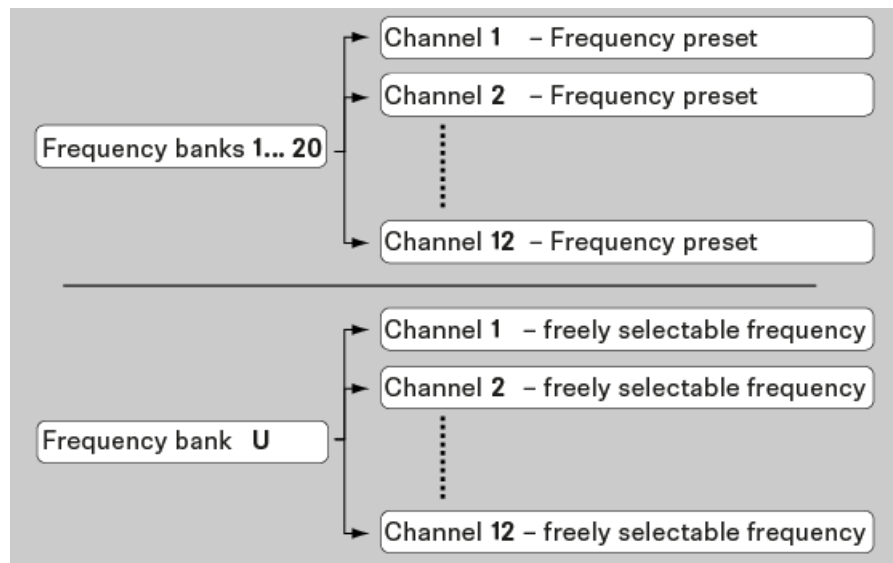

i You can find information about the frequency presets in the frequency tables of the respective frequency ranges under “Frequency tables”.



INSTALLATION

Installing ew 100 P G4 series devices

You can find information about installing and connecting ew 100 P G4 series devices in the following sections.



- **EK 100 G4** diversity receiver >> “Installing the EK 100 G4”



- **SKM 100 G4** handheld transmitter >> “Installing the SKM 100 G4”

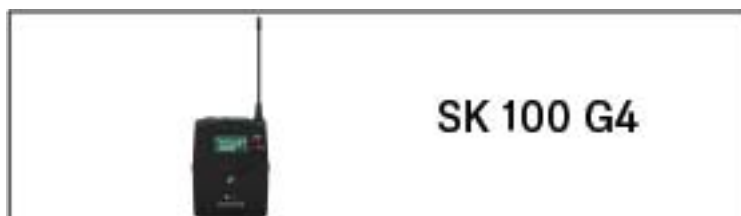

- **SK 100 G4** bodypack transmitter >> “Installing the SK 100 G4”



- **SKP 100 G4** plug-on transmitter >> “Installing the SKP 100 G4”



You can find information about **operating** the products under “Using ew 100 P G4 series devices”.



Installing the EK 100 G4

These sections contain detailed information about installing the EK 100 G4.

You can find information about operating the EK 100 G4 under “Using the EK 100 G4”.

Inserting and removing the batteries/rechargeable batteries

You can operate the diversity receiver either with batteries (AA, 1.5 V) or with the rechargeable Sennheiser BA 2015 battery.

- ▷ Press the two catches and open the battery compartment cover.
- ▷ Insert the batteries or the rechargeable battery as shown below. Please observe correct polarity when inserting the batteries.









- ▷ Close the battery compartment.
The cover locks into place with an audible click.



Battery status

Charge status of the batteries:

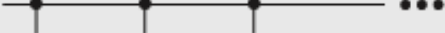
	100 %	> 8 h
	70 %	4 - 6 h
	30 %	2 - 3 h
LOW BATT 	  	

Charge status is critical (LOW BATT):

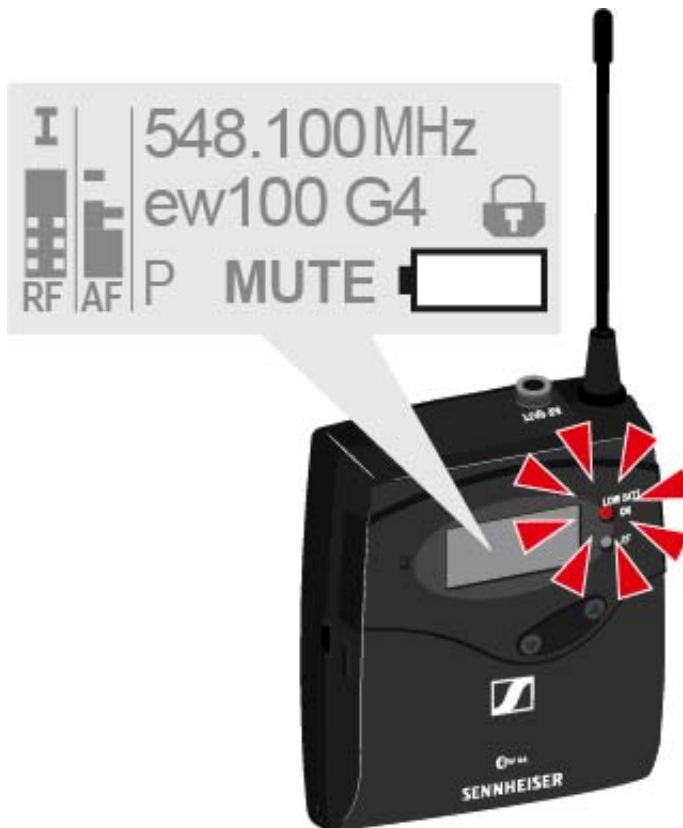



Attaching the diversity receiver to a camera

You can attach the diversity receiver on the hot shoe of the camera with the included CA 2 camera kit.

To attach the EK 100 G4 diversity receiver to a camera:

- ▷ Determine where on the perforated plate you need to attach the hot shoe adapter so that the diversity receiver can be optimally attached to the camera.
- ▷ Place a square nut under the perforated plate at this position.
- ▷ Affix the hot shoe adapter to the perforated plate with the square nut.

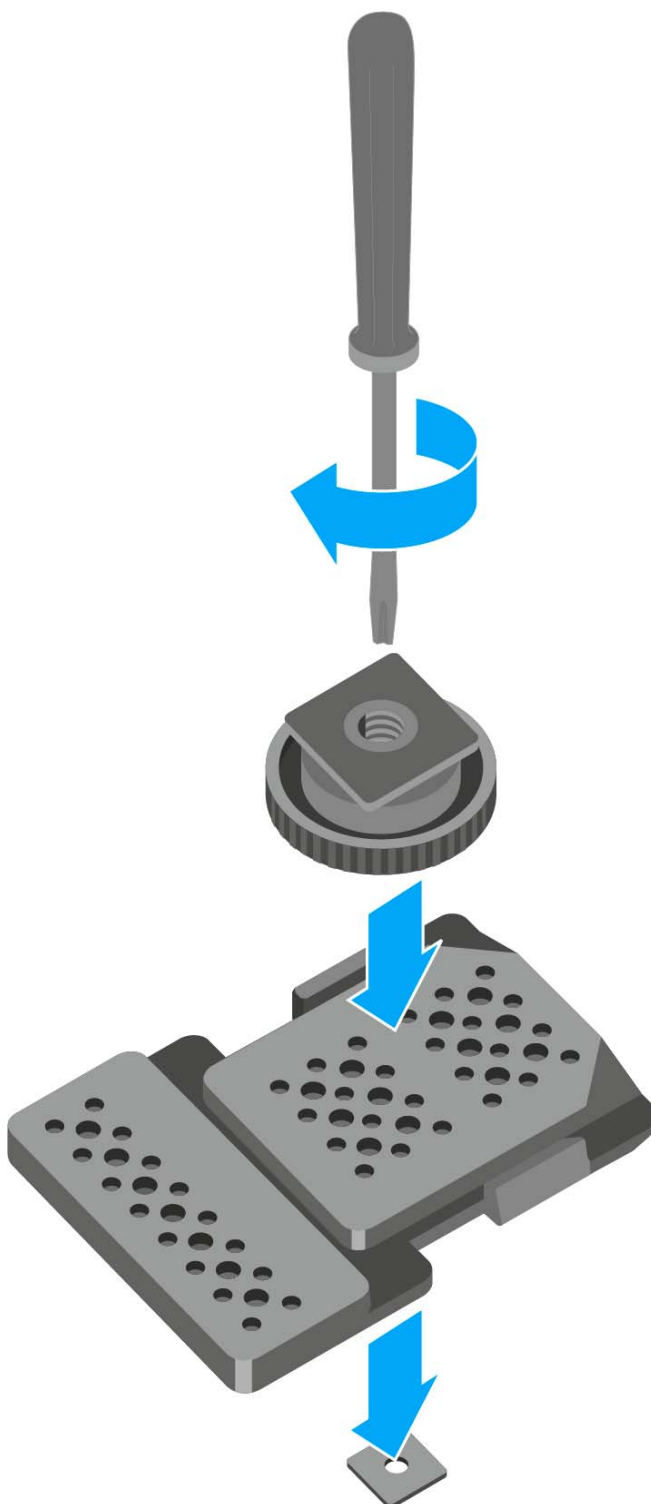



- ▷ Lift the belt clip.
- ▷ Press one side of the clip downward on the fixing hole and pull it out of the housing.
- ▷ Do the same thing on the other side.

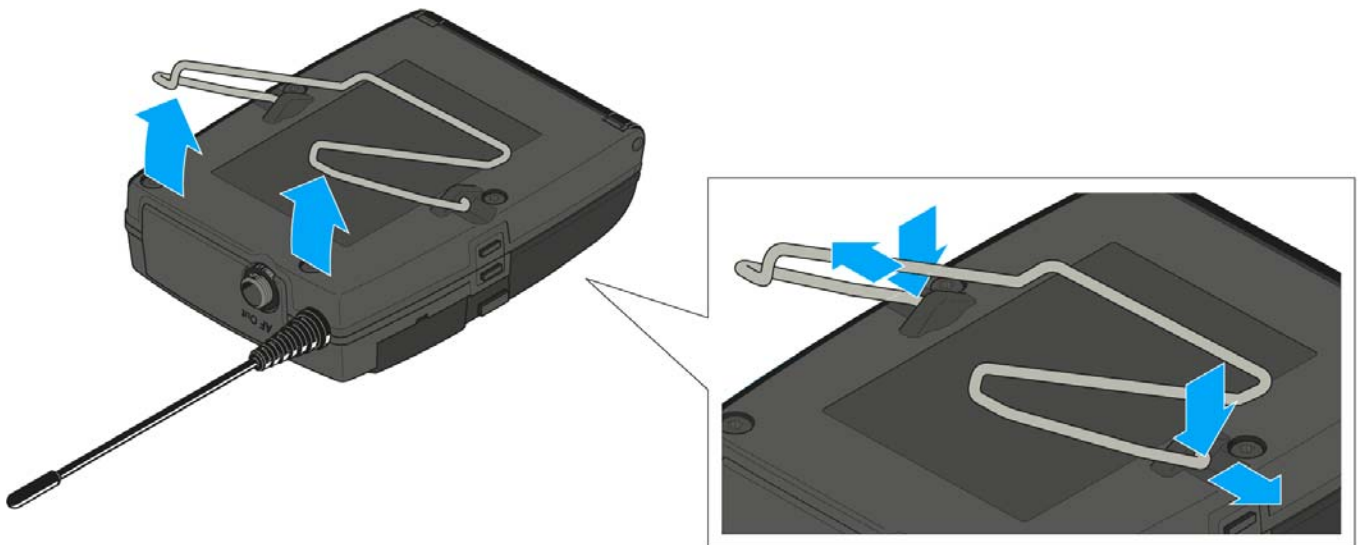

- ▷ Place the perforated plate on the rear side of the diversity receiver.
- ▷ Reattach the clip.

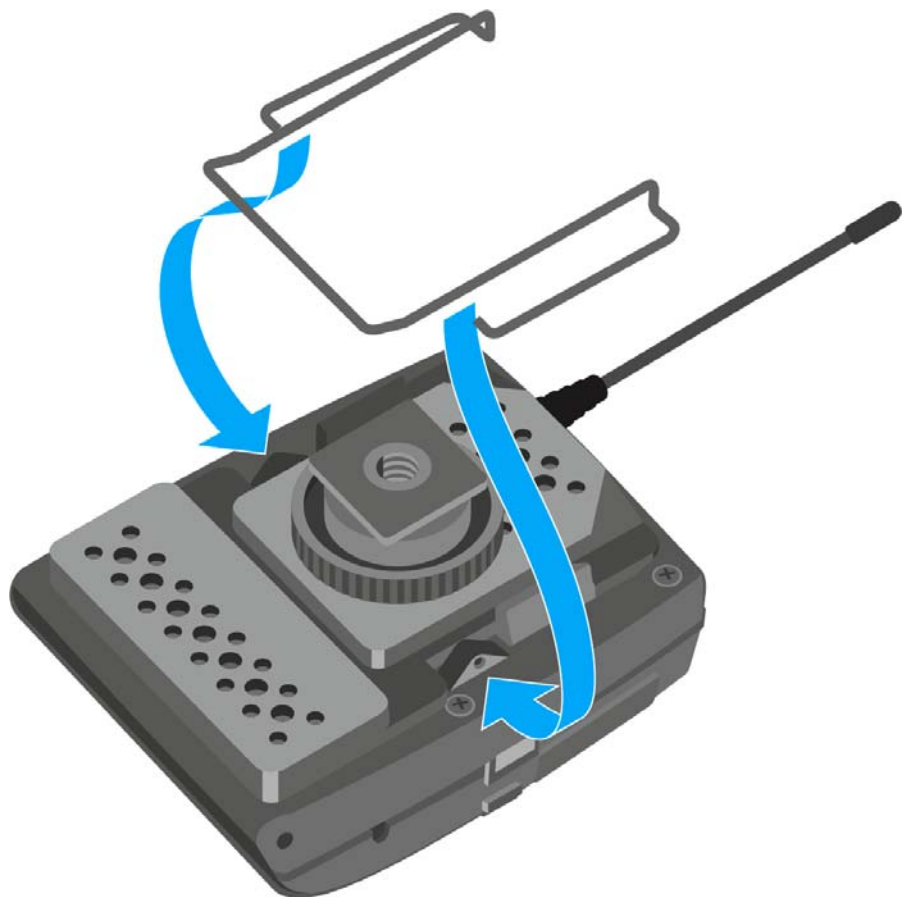



▷ Slide the receiver onto a camera.

◀ OR ▶

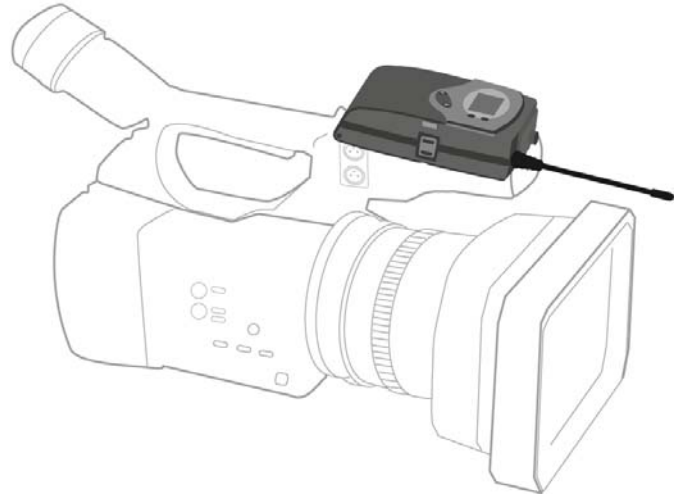
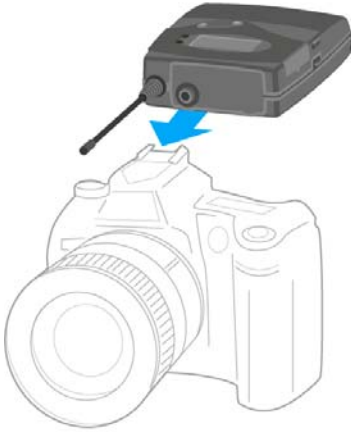



Connecting the diversity receiver to a camera

To connect the diversity receiver to a camera:

- ▷ Attach the line input of the camera to the jack socket of the receiver using one of the enclosed line connecting cables.





◀ OR ▶

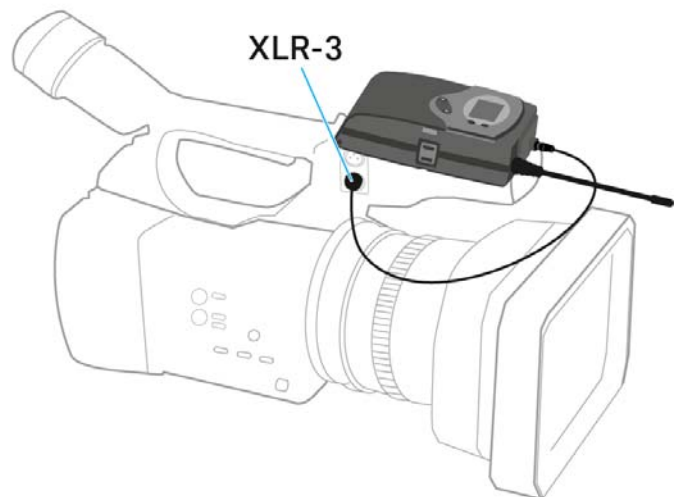
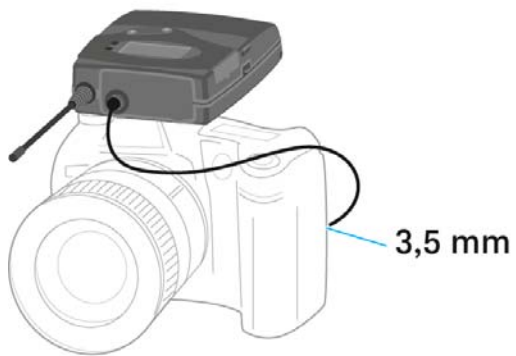

- ▶ Adjust the level of the **AF Out** audio output in the operating menu of the diversity receiver based on the input level of the camera (see “AF Out menu item”).

i The shielding of the line cable acts as an antenna for the second diversity branch. For details on the pin assignment, see “Pin assignment”.



Installing the SKM 100 G4

These sections contain detailed information about installing and starting up the SKM 100 G4.

You can find information about operating the SKM 100 G4 under “Using the SKM 100 G4”.



Inserting and removing the batteries/rechargeable batteries

You can operate the wireless microphone either with batteries (AA, 1.5 V) or with the rechargeable Sennheiser BA 2015 battery.

- ▷ Screw the rear part of the wireless microphone in the direction of the arrow (counter-clockwise) off of the handle of the wireless microphone.

i When you remove the wireless microphone during operation, mute is automatically activated. **MUTE** appears in the display panel. When you screw the microphone back together, mute is deactivated.

- ▷ Pull the rear part of the wireless microphone all the way out.
- ▷ Open the cover of the battery compartment.
- ▷ Place the batteries or the BA 2015 rechargeable battery in the battery compartment as shown on the cover. Please observe correct polarity when inserting the batteries/accupack.

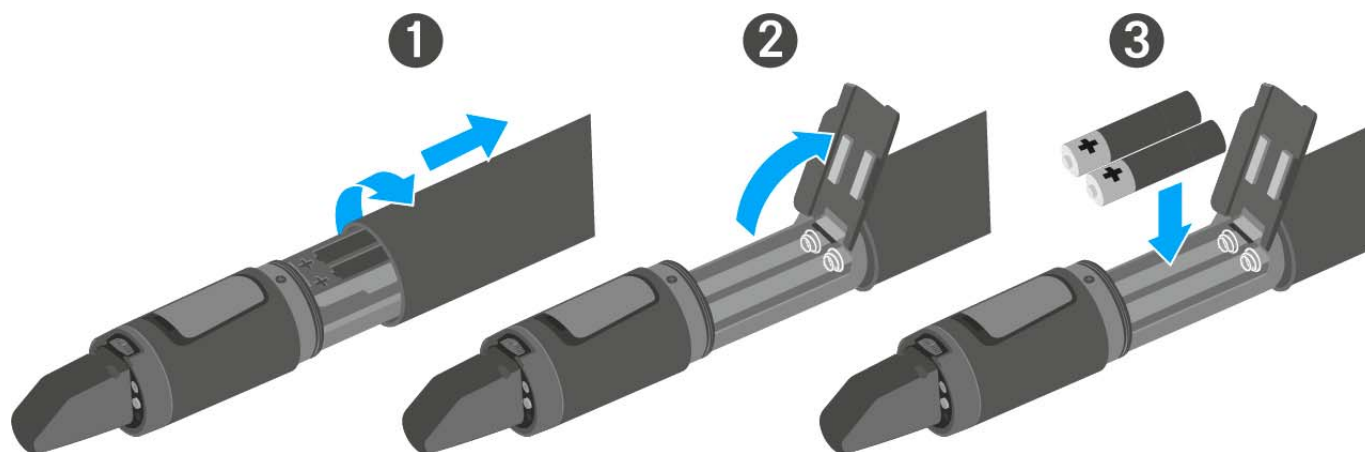







- ▷ Close the cover.
- ▷ Push the battery compartment into the handle of the wireless microphone.
- ▷ Screw the rear part of the wireless microphone back onto the handle.



Battery status

Charge status of the batteries:

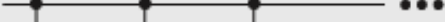
	100 %	> 8 h
	70 %	4 - 6 h
	30 %	2 - 3 h
LOW BATT 	  	

Charge status is critical (LOW BATT):

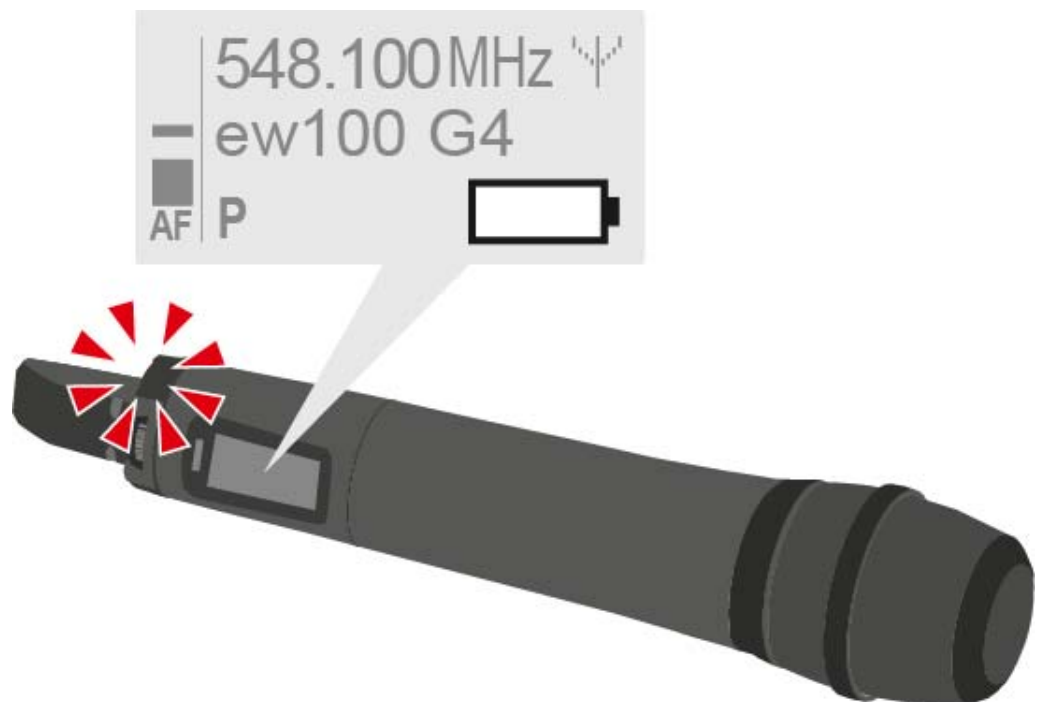



Replacing the microphone module

You can find a list of the recommended microphone modules for the handheld transmitter under “Microphones and cables”.

To change the microphone module:

- ▷ Unscrew the microphone module.
- ▷ Screw the desired microphone module on.



i Do not touch the wireless microphone contacts or the microphone module contacts. If you touch the contacts, they may become dirty or bent.

When you unscrew the microphone module during operation, mute is automatically activated. **MUTE** appears in the display panel. When you screw the microphone module back on, mute is deactivated.



Changing the colored ring

To change the colored ring:

- ▷ Pull the colored ring off as shown in the diagram.

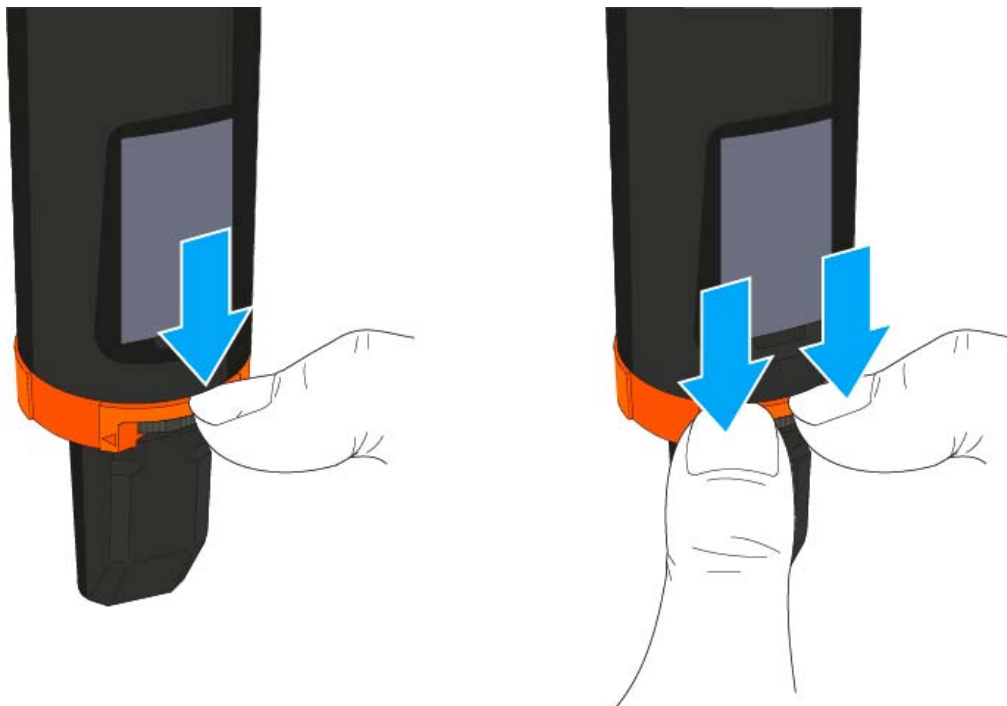

- ▷ Attached a colored ring in the color you want as shown in the diagram.

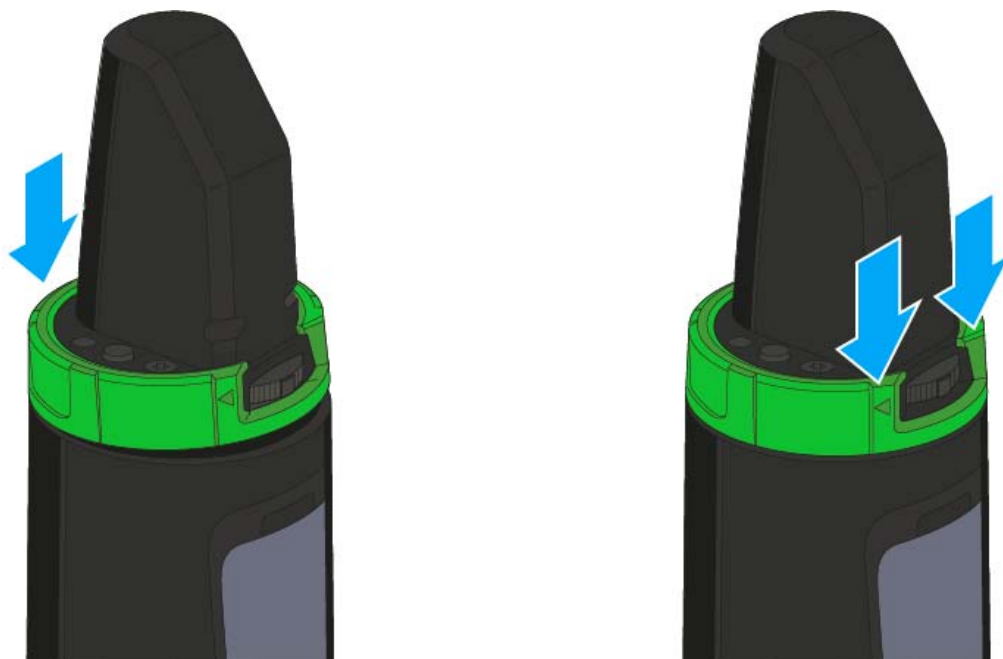



Installing the SK 100 G4

These sections contain detailed information about installing and starting up the SK 100 G4.

You can find information about operating the SK 100 G4 under “Using the SK 100 G4”.



Inserting and removing the batteries/rechargeable batteries

You can operate the bodypack transmitter either with batteries (AA, 1.5 V) or with the rechargeable Sennheiser BA 2015 battery.

- ▷ Press the two catches and open the battery compartment cover.
- ▷ Insert the batteries or the rechargeable battery as shown below. Please observe correct polarity when inserting the batteries.









- ▷ Close the battery compartment.
The cover locks into place with an audible click.



Battery status

Charge status of the batteries:

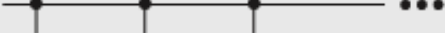
	100 %	> 8 h
	70 %	4 - 6 h
	30 %	2 - 3 h
LOW BATT 	  	

Charge status is critical (LOW BATT):

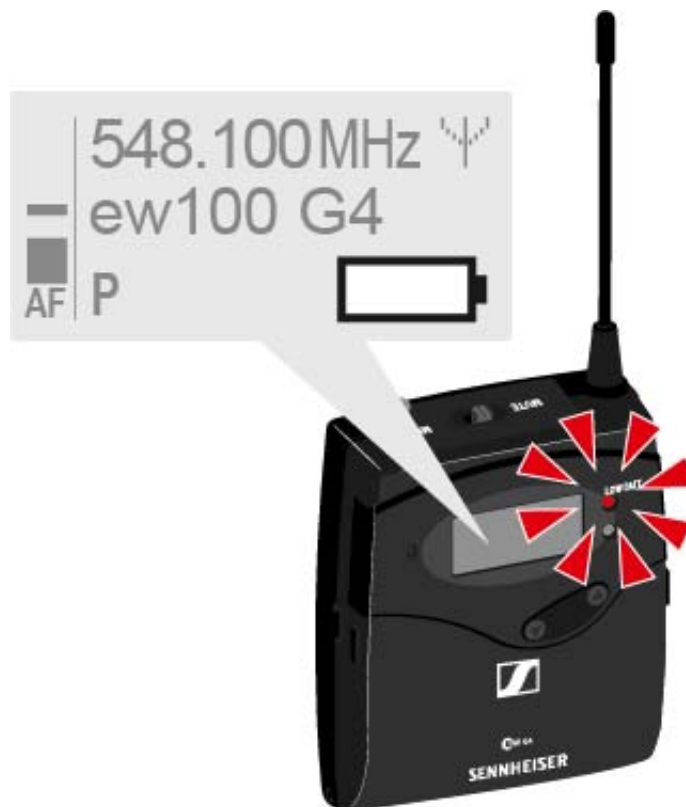



Connecting a microphone to the SK 100 G4

You can find a list of recommended Lavalier and headset microphones for the bodypack transmitter under “Microphones and cables”.

To connect a microphone to the bodypack transmitter:

- ▷ Insert the cable’s 3.5 mm jack plug into the MIC/LINE socket on the bodypack transmitter as shown in the diagram.
- ▷ Screw the plug’s coupling ring onto the audio socket thread of the bodypack transmitter.





Connecting an instrument or line source to the SK 100 G4

You can connect instruments or audio sources with a line level to the bodypack transmitter.

To do this, you will need the **Ci 1-N** (6.3 mm jack plug on a lockable 3.5 mm jack plug) or **CL 2** (XLR-3F plug on lockable 3.5 mm jack plug) Sennheiser cables.

To connect an instrument or line source to bodypack transmitter:

- ▷ Insert the cable's 3.5 mm jack plug into the MIC/LINE socket on the bodypack transmitter as shown in the diagram.
- ▷ Screw the plug's coupling ring onto the audio socket thread of the bodypack transmitter.





Attaching the bodypack transmitter to clothing

You can use the belt clip to attach the bodypack transmitter to your waistband or on a guitar strap.

The belt clip is detachable so that you can also attach the bodypack transmitter with the antenna pointing downwards. To do so, withdraw the belt clip from its fixing points and attach it the other way round.

The belt clip is secured so that it cannot slide out of its fixing points accidentally.



To detach the belt clip:

- ▷ Lift the belt clip as shown in the diagram.
- ▷ Press one side of the clip downward on the fixing hole and pull it out of the transmitter housing.
- ▷ Do the same thing on the other side.

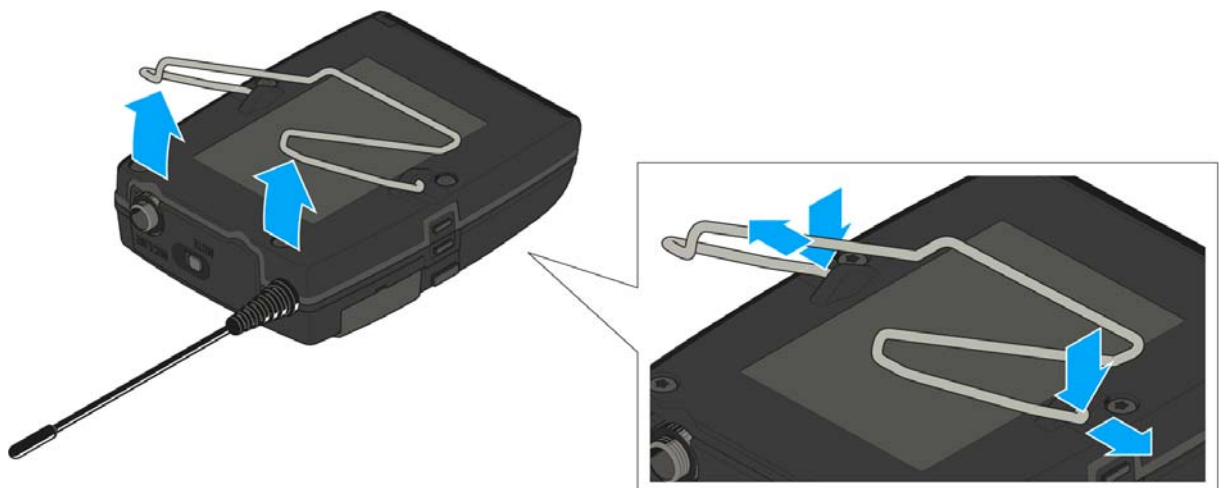



Installing the SKP 100 G4

These sections contain detailed information about installing the SKP 100 G4.

You can find information about operating the SKP 100 G4 under “Using the SKP 100 G4”.



Inserting and removing the batteries/rechargeable batteries

You can operate the plug-on transmitter either with batteries (AA, 1.5 V) or with the rechargeable Sennheiser BA 2015 battery.

- ▷ Slide the battery compartment cover in the direction of the embossed arrow and open the cover.
- ▷ Insert the batteries or the accupack as shown below. Please observe correct polarity when inserting the batteries/accupack.

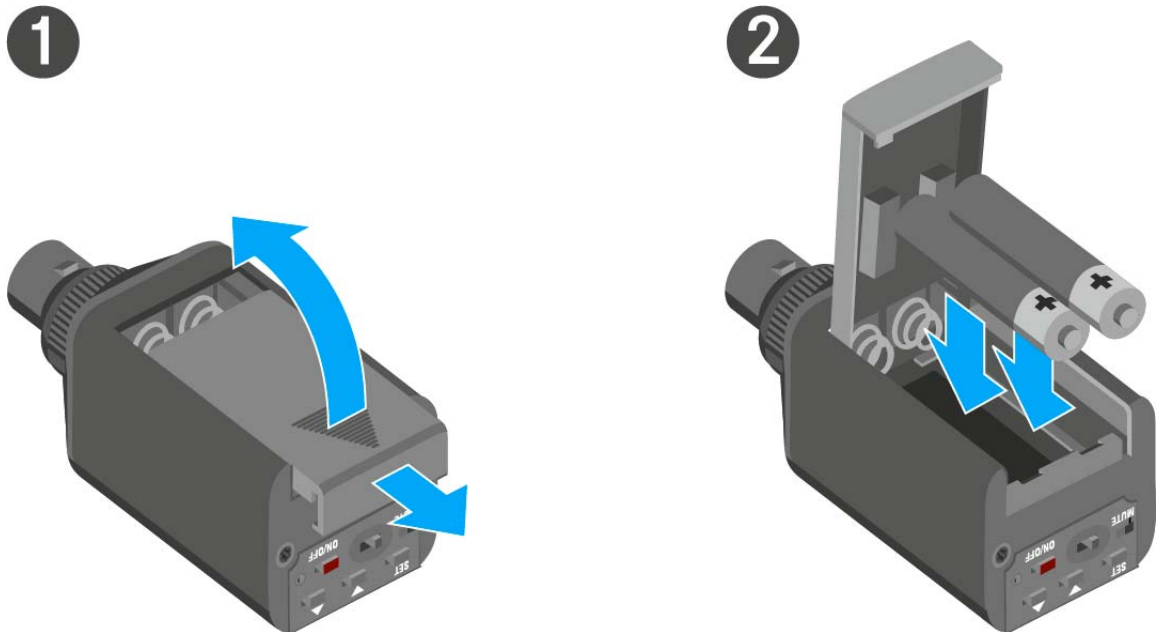







- ▷ Close the battery compartment.
The cover locks into place with an audible click.



Battery status

Charge status of the batteries:

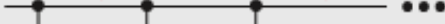
	100 %	> 8 h
	70 %	4 - 6 h
	30 %	2 - 3 h
LOW BATT 	  	

Charge status is critical (LOW BATT):





Attaching the plug-on transmitter to the microphone

i Microphones with a metal casing should be used for optimal signal transmission.

- ▷ Loosen the locking ring (2) by rotating it in the clockwise direction past the center point.
This unlocks the XLR-3 plug (1) of the plug-on transmitter.
- ▷ Connect the plug-on transmitter's XLR-3 plug (1) to the XLR-3 socket of the microphone.
- ▷ Tighten the locking ring (2) by rotating it counter-clockwise in the direction of the arrow.

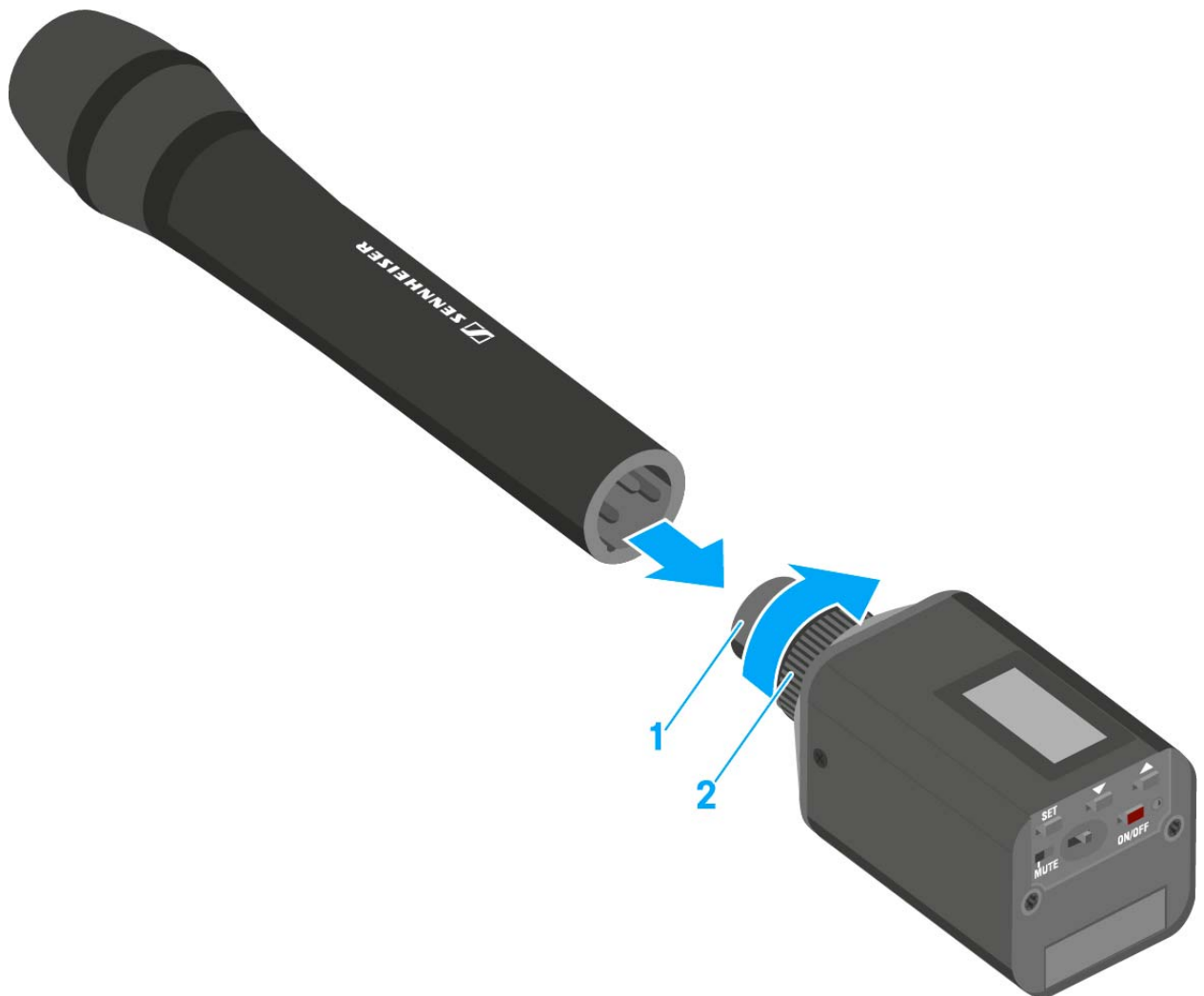



OPERATION

Using ew 100 P G4 series devices

You can find information about using ew 100 P G4 series devices in the following sections.



EK 100 G4

- **EK 100 G4** diversity receiver >> “Using the EK 100 G4”

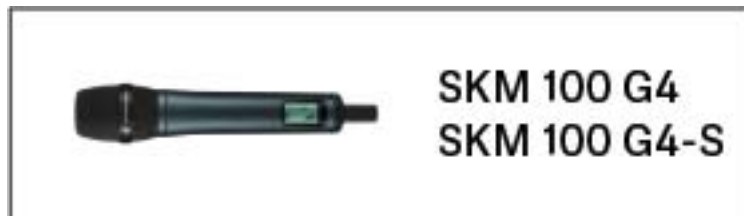

SKM 100 G4
SKM 100 G4-S

- **SKM 100 G4** handheld transmitter >> “Using the SKM 100 G4”



SK 100 G4

- **SK 100 G4** bodypack transmitter >> “Using the SK 100 G4”



SKP 100 G4

- **SKP 100 G4** plug-on transmitter >> “Using the SKP 100 G4”

i You can find information about **installing** the products under “Installing ew 100 P G4 series devices”.



In the sections below, you can find important **information about specific use cases**.



- Establishing a **radio link** between the transmitter and receiver >> “Establishing a radio link”

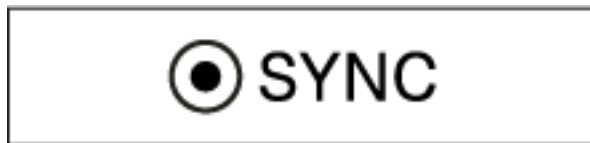

- **Synchronizing** the receiver **settings** to the transmitter >> “Synchronizing devices”

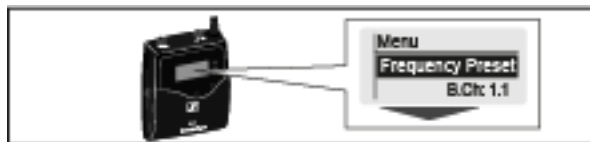

- Using the **menu** of the diversity **receiver** >> “Displays on the EK 100 G4 display panel”

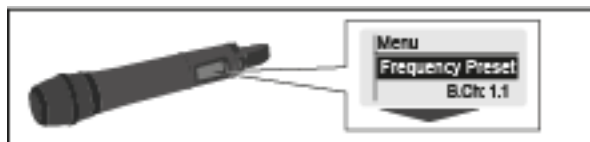

- Using the **menu** of the **handheld transmitter** >> “Displays on the SKM 100 G4 handheld transmitter display panel”

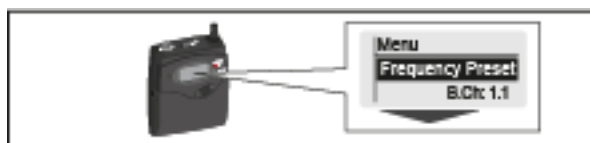

- Using the **menu** of the **bodypack transmitter** >> “Displays on the SK 100 G4 bodypack transmitter display panel”

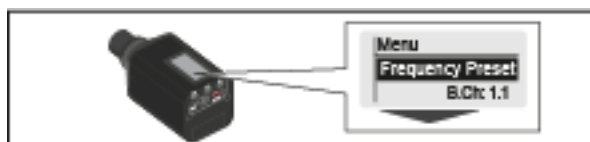

- Using the menu of the **plug-on transmitter** >> “Displays on the SKP 100 G4 plug-on transmitter display panel”



Using the EK 100 G4

These sections contain detailed information about using the EK 100 G4.

You can find information about installing the EK 100 under “Installing the EK 100 G4”.



Operating elements of the EK 100 G4 diversity receiver



- 1** Display panel
 - See “Displays on the EK 100 G4 display panel”
- 2** Operation and battery indicator, red LED
 - illuminated = ON
See “Switching the EK 100 G4 on and off”
 - flashing = LOW BATTERY
See “Inserting and removing the batteries/rechargeable batteries”
- 3** Wireless reception indicator, green LED
 - illuminated = RF
- 4** UP button
 - See “Buttons for navigating through the menu”
- 5** SET button
 - See “Buttons for navigating through the menu”
- 6** DOWN button
 - See “Buttons for navigating through the menu”



7 **ON/OFF** button with ESC function in the operating menu

- Switch the transmitter on or off
See “Switching the EK 100 G4 on and off”
- Escape function in the menu
See “Buttons for navigating through the menu”

8 Infra-red interface

- See “Synchronizing devices”

9 3.5 mm jack socket

- lockable
See “Connecting the diversity receiver to a camera”

Switching the EK 100 G4 on and off

- ▷ Press the two catches and open the battery compartment cover.

To switch the receiver on:

- ▷ Hold down the **ON/OFF** button until the Sennheiser logo appears on the display.



To switch the receiver off:

- ▷ Hold down the **ON/OFF** button until the display goes off.



Lock-off function

You can set the automatic lock-off function in the **Auto lock** menu (see “Auto Lock menu item”).

When you have switched on the lock-off function, you will have to turn the transmitter off and on again in order to operate it.

To temporarily deactivate the lock-off function:

- ▷ Press the **SET** button.
Locked appears in the display panel.
- ▷ Press the **UP** or **DOWN** button.
Unlock? appears in the display panel.
- ▷ Press the **SET** button.
Lock-off function is now temporarily deactivated.

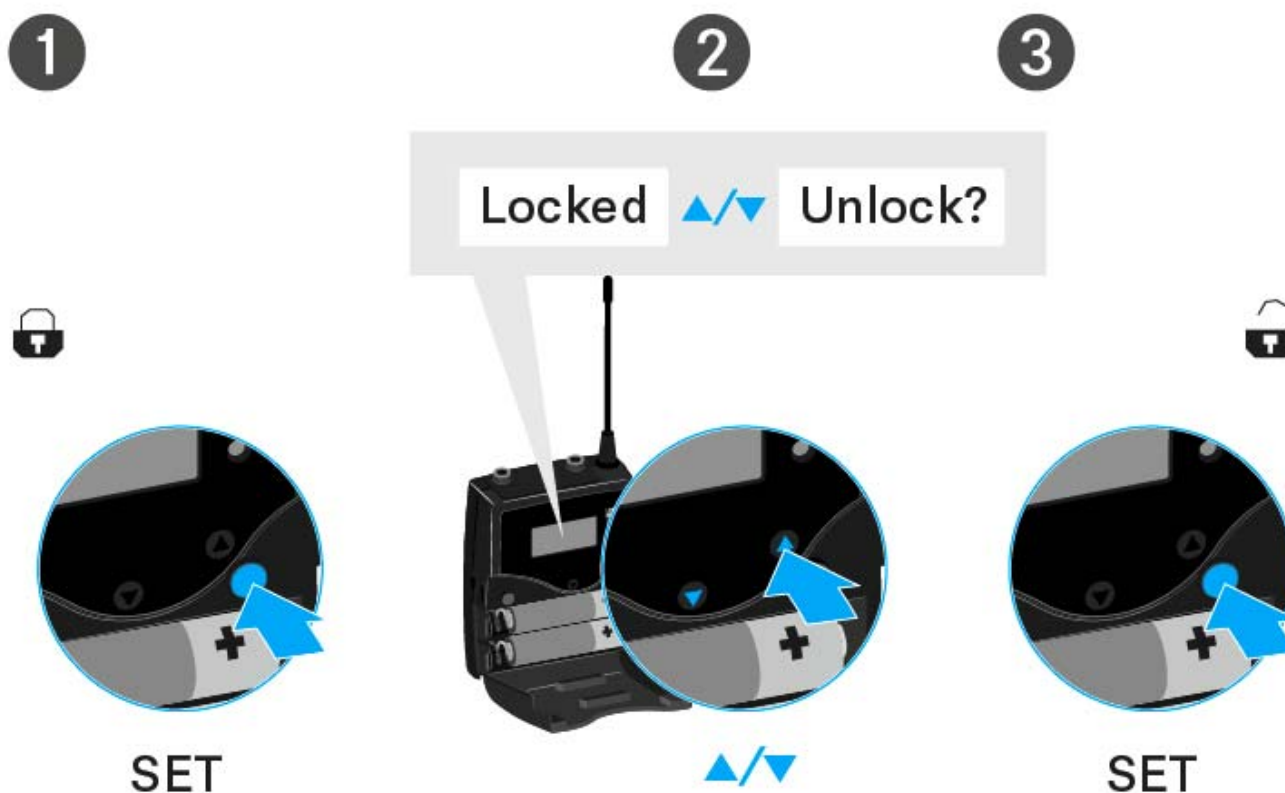

When you are in the operating menu

>> Lock-off function is deactivated long enough for you to work in the operating menu.

When one of the standard displays is shown

>> Lock-off function is automatically activated after 10 seconds.

The Lock-off function icon flashes while the lock-off function is being activated again.



Displays on the EK 100 G4 display panel

Status information such as reception quality, battery status, audio level, etc. is displayed on the **home screen** of the display panel. See “Home screen”.

The display panel also displays the **operating menu** which you can use to configure all of the **settings**. See “Setting options in the menu”.



Buttons for navigating through the menu

To navigate through the EK 100 G3 operating menu, you need the following buttons.



ON/OFF



Press the **ON/OFF** button

- ESC function: Cancels the entry and returns to the current standard display
- Selects a standard display (see “Home screen”)

SET



Press the **SET** button

- Changes from the current standard display to the operating menu
- Calls up a menu item
- Changes to a submenu
- Stores the settings and returns to the operating menu



Press the **UP** or **DOWN** button

- Changes to the previous or next menu item
 - Changes the setting of a menu item
-



Home screen

After you switch on the receiver, the display panel initially displays the Sennheiser logo. After a short time, the home screen is then displayed.

The home screen has two different standard displays.

- ▷ Short-press the **ON/OFF** button to switch between the standard displays.

Frequency/Name standard display

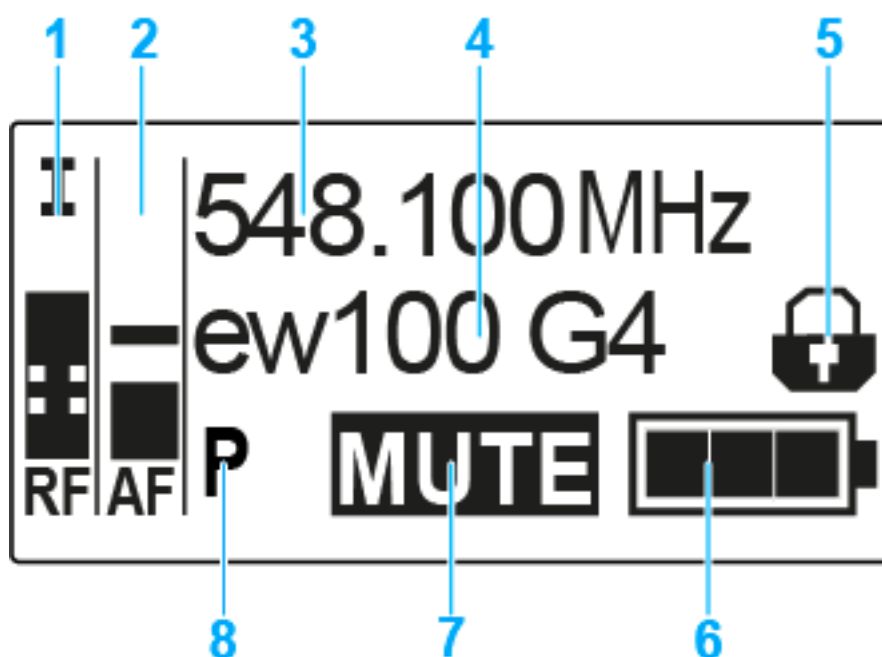

- 1** RF level (radio frequency)
 - RF signal level display
 - including the display of the squelch threshold (see "Squelch menu item")
- 2** AF audio level (audio frequency)
 - Displays the audio level of the received transmitter
 - When the display shows full deflection, the audio input level is excessively high.
 - See "AF Out menu item"
- 3** Frequency
 - Current receiving frequency
 - See "Frequency Preset menu item"
- 4** Name
 - Freely selectable name of the receiver
 - See "Name menu item"
- 5** Lock-off function
 - Lock-off function is activated on the receiver
 - See "Lock-off function"



- 6** Battery status of the receiver
 - See “Inserting and removing the batteries/rechargeable batteries”
- 7 MUTE** muting function
 - No RF signal received
- 8 P** pilot tone
 - P = Activated pilot tone evaluation
 - No symbol = Evaluation is deactivated
 - P is black = Pilot tone is being received on the current frequency
 - See “Advanced -> Pilot Tone menu item”

Frequency Bank/Channel/Name **standard display**

The Frequency Bank/Channel/Name standard display shows the level of the line output **AF Out** instead of the **MUTE** muting function.

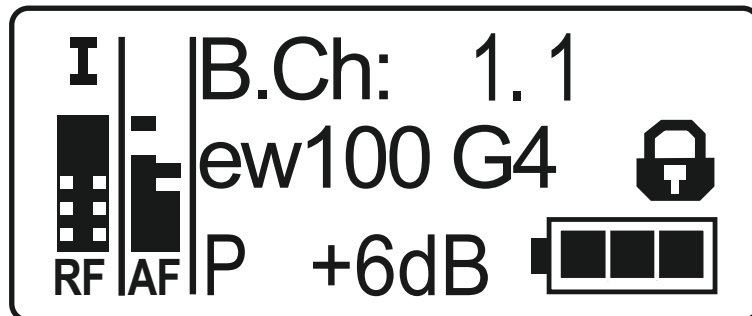



Setting options in the menu

In the EK 100 G4 menu, you can configure the following settings.

Synchronizing the transmitter with the diversity receiver

- ▷ See “Sync menu item”
-

Adjusting the squelch threshold

- ▷ See “Squelch menu item”
-

Scanning for unused frequency presets, releases and selects frequency presets

- ▷ See “Easy Setup menu item”
-

Setting the frequency bank and the channel

- ▷ See “Frequency Preset menu item”
-

Entering a freely selectable name

- ▷ See “Name menu item”
-

Adjusting the audio output level

- ▷ See “AF Out menu item”
-

Activate/deactivate the automatic lock-off function

- ▷ See “Auto Lock menu item”
-

Configuring enhanced settings in the [Advanced Menu](#):

- Adjusting the receiving frequencies for the U frequency bank
 - Activating/deactivating the pilot tone evaluation
 - Adjusting the contrast of the display panel
 - Resetting the receiver
 - Displaying the current software revision
 - ▷ See “Advanced menu item”
-



Menu structure

The figure shows the complete EK 100 G4 menu structure in an overview.

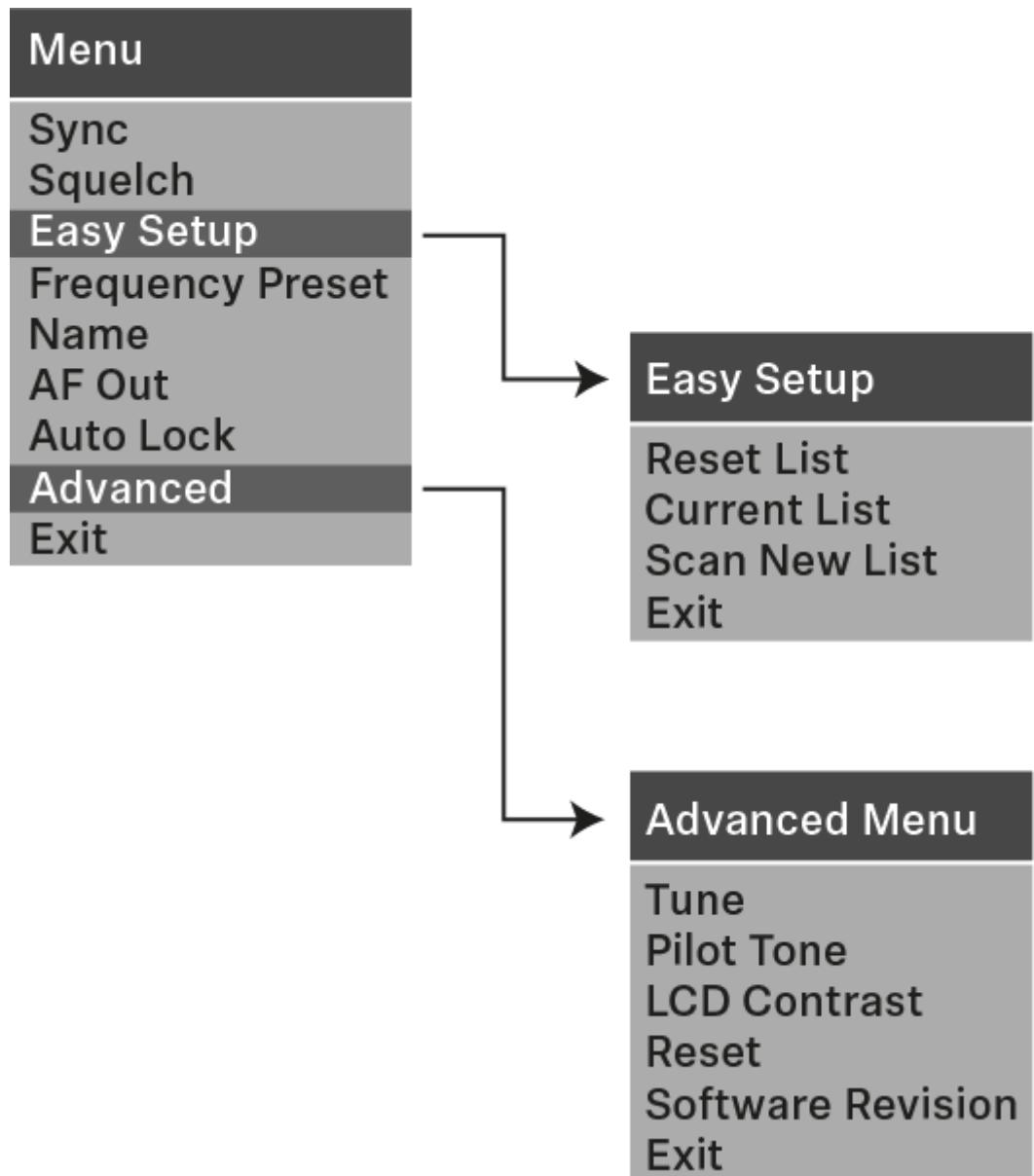



Sync menu item

In the **Sync** menu item you can synchronize ew 100 P G4 series transmitters and receivers.



For more information, see “Establishing a radio link”.



Squelch menu item

You can adjust the squelch threshold in the **Squelch** menu item.

Setting range:

- **Low** >> 5 dB μ V
- **Middle** >> 15 dB μ V
- **High** >> 25 dB μ V

The squelch threshold is displayed on the home screen in the RF signal level area.

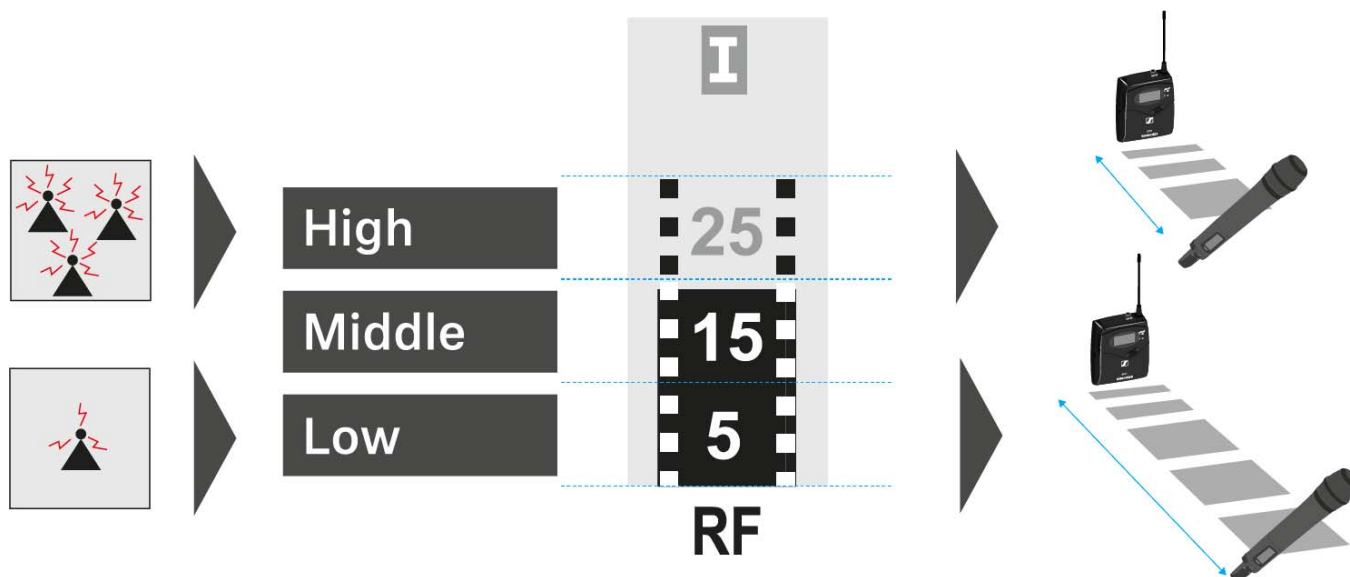

To open the **Squelch** menu item:

- ▷ On the home screen, press the **SET** button to open the operating menu.
- ▷ Press the **UP** or **DOWN** button until the **Squelch** menu item appears in the selection frame.
- ▷ Press the **SET** button to open the menu item.
- ▷ Adjust the settings as desired.

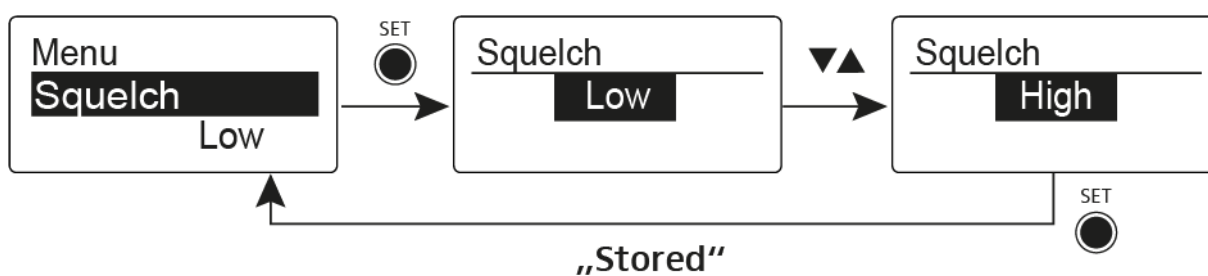

- ▷ Press the **SET** button to save the changes you made to the settings.
or
- ▷ Press the **ON/OFF** button to cancel the entry without saving the settings.



CAUTION**Risk of hearing and material damage**

If you set the squelch threshold to a very low value, a very loud hissing noise can occur in the receiver. This hissing noise can be loud enough to cause hearing damage or overload your system's loudspeakers.

- ▷ Before adjusting the squelch threshold, set the volume of the audio output to the minimum.
 - ▷ Never change the squelch threshold during a live transmission.
-



Easy Setup menu item

You can scan for unused frequencies using the **Easy Setup** menu item.



Switch off all transmitters before you perform the scan. If transmitters are still switched on, they are detected as unavailable frequencies and the frequencies that are actually available cannot then be used.

To open the **Easy Setup** menu item:

- ▷ On the home screen, press the **SET** button to open the operating menu.
- ▷ Press the **UP** or **DOWN** button until the **Easy Setup** menu item appears in the selection frame.
- ▷ Press the **SET** button to open the menu item.
- ▷ Adjust the settings as desired.

- **Scan New List:** Automatically searches for unused receiving frequencies (frequency preset scan):

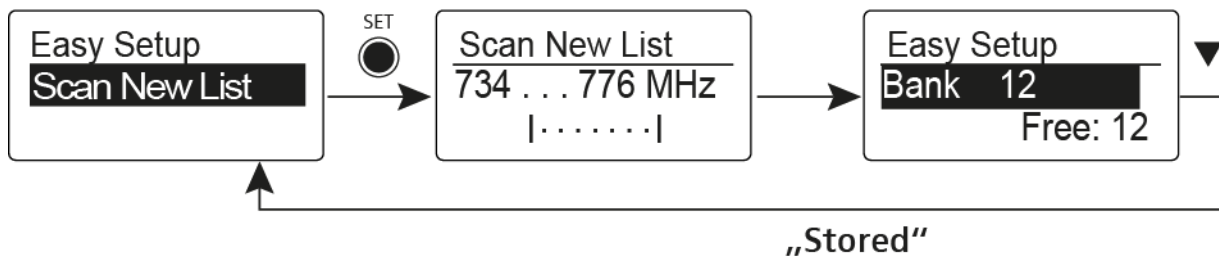

- **Current List:** Selects an unused frequency preset:

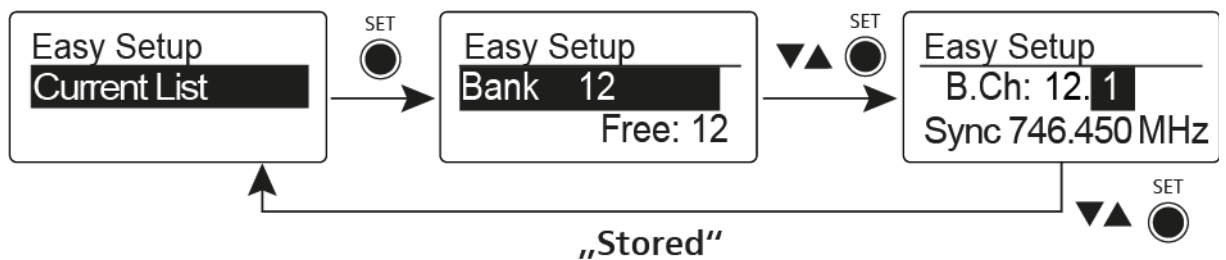

- **Reset List:** Releases all occupied frequency presets and selects an unused frequency preset:

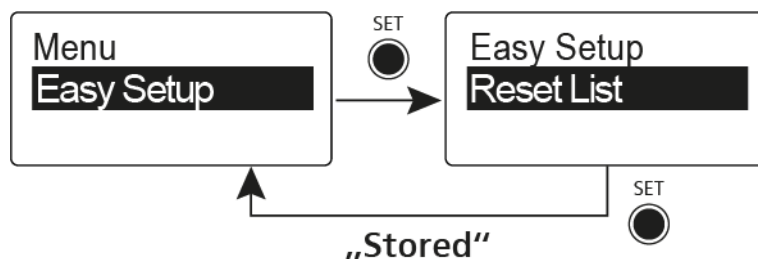



- ▷ Press the **SET** button to save the changes you made to the settings.
or
- ▷ Press the **ON/OFF** button to cancel the entry without saving the settings.



Frequency Preset menu item

In the **Frequency Preset** menu item, you can adjust the receiving frequency of the receiver by adjusting the frequency bank and the channel.

To open the **Frequency Preset** menu item:

- ▷ On the home screen, press the **SET** button to open the operating menu.
- ▷ Press the **UP** or **DOWN** button until the **Frequency Preset** menu item appears in the selection frame.
- ▷ Press the **SET** button to open the menu item.
- ▷ Adjust the settings as desired.

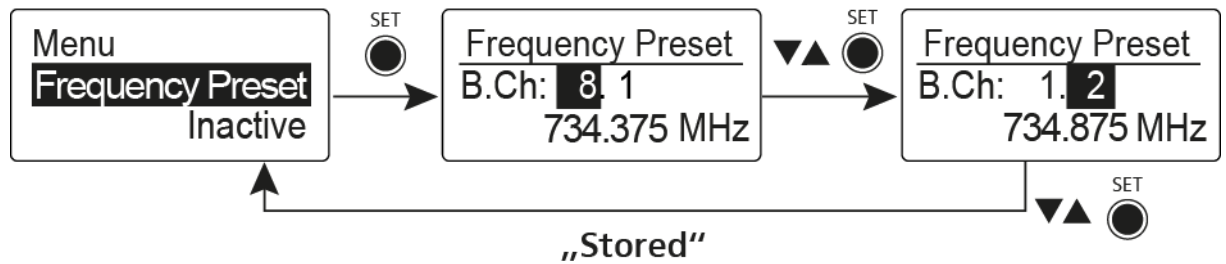

- ▷ Press the **SET** button to save the changes you made to the settings.
or
- ▷ Press the **ON/OFF** button to cancel the entry without saving the settings.



Name menu item

In the **Name** menu item you can enter a name for the radio link.

To open the **Name** menu item:

- ▷ On the home screen, press the **SET** button to open the operating menu.
- ▷ Press the **UP** or **DOWN** button until the **Name** menu item appears in the selection frame.
- ▷ Press the **SET** button to open the menu item.
- ▷ Adjust the settings as desired.

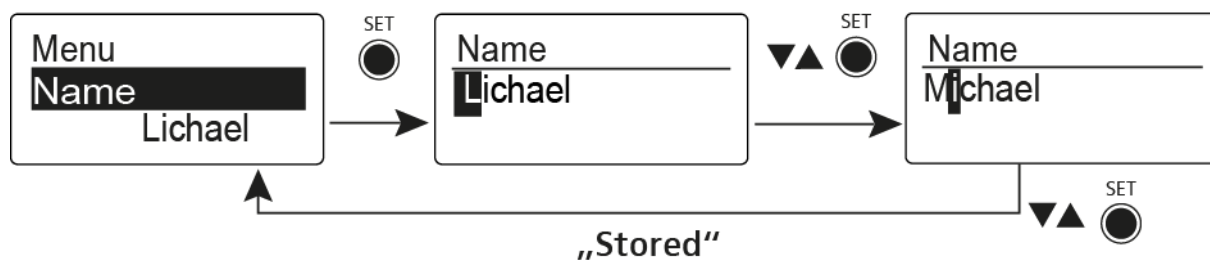

- ▷ Press the **SET** button to save the changes you made to the settings.
or
- ▷ Press the **ON/OFF** button to cancel the entry without saving the settings.



AF Out menu item

In the **AF Out** menu item you can adjust the level of the line audio output based on the level of the connected camera.

Setting range:

- -30 dB to +12 dB in 6 dB steps

To open the **AF Out** menu item:

- ▷ On the home screen, press the **SET** button to open the operating menu.
- ▷ Press the **UP** or **DOWN** button until the **AF Out** menu item appears in the selection frame.
- ▷ Press the **SET** button to open the menu item.
- ▷ Adjust the settings as desired.

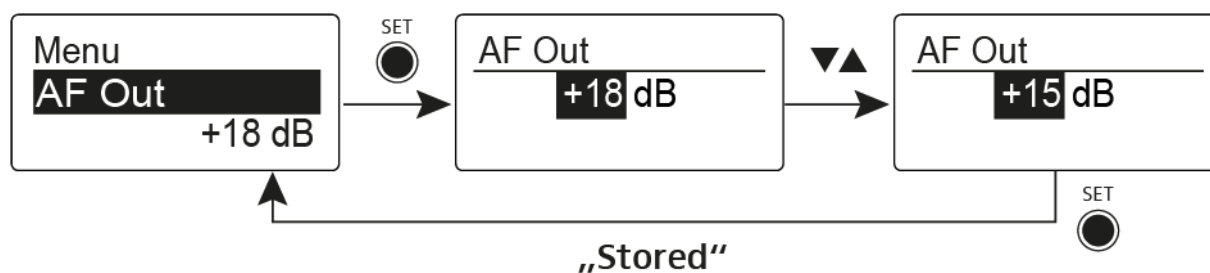

- ▷ Press the **SET** button to save the changes you made to the settings.
or
- ▷ Press the **ON/OFF** button to cancel the entry without saving the settings.



Auto Lock menu item

In the **Auto Lock** menu item you can activate or deactivate the auto lock-off function.

i You can find information about temporarily deactivating the lock-off function during operation under “Lock-off function”.

To open the **Auto Lock** menu item:

- ▷ On the home screen, press the **SET** button to open the operating menu.
- ▷ Press the **UP** or **DOWN** button until the **Auto Lock** menu item appears in the selection frame.
- ▷ Press the **SET** button to open the menu item.
- ▷ Adjust the settings as desired.

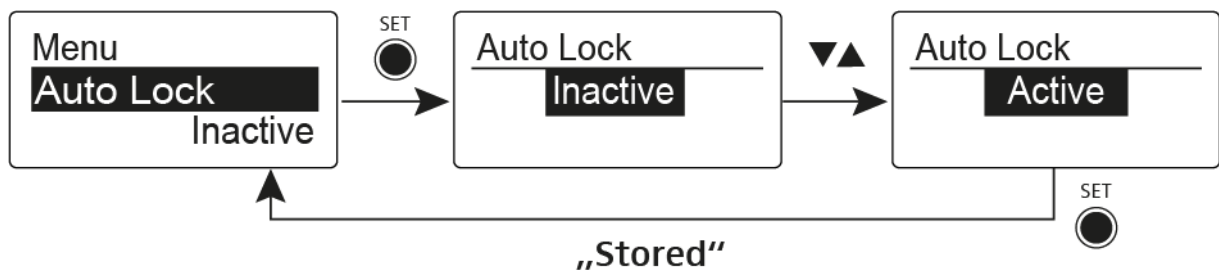

- ▷ Press the **SET** button to save the changes you made to the settings.
or
- ▷ Press the **ON/OFF** button to cancel the entry without saving the settings.



Advanced menu item

In the **Advanced** submenu you can configure enhanced settings.

To open the **Advanced** submenu:

- ▷ On the home screen, press the **SET** button to open the operating menu.
- ▷ Press the **UP** or **DOWN** button until the **Advanced** menu item appears in the selection frame.
- ▷ Press the **SET** button to open the menu item.

The following sub-items are available:

Adjusting the receiving frequency for the frequency bank U

- ▷ See “Advanced -> Tune menu item”

Activating/deactivating the pilot tone evaluation

- ▷ See “Advanced -> Pilot Tone menu item”

Adjusting the contrast of the display panel

- ▷ See “Advanced -> LCD Contrast menu item”

Resetting the receiver

- ▷ See “Advanced -> Reset menu item”

Displaying the current software revision

- ▷ See “Advanced -> Software Revision menu item”
-



Advanced -> Tune menu item

In the **Tune** menu item of the **Advanced** submenu, you can configure the receiving frequencies for the **U** frequency bank.

Only adjusting the frequency

- ▷ Open the **Tune** menu item in the **Advanced** menu.
- ▷ Adjust the settings.

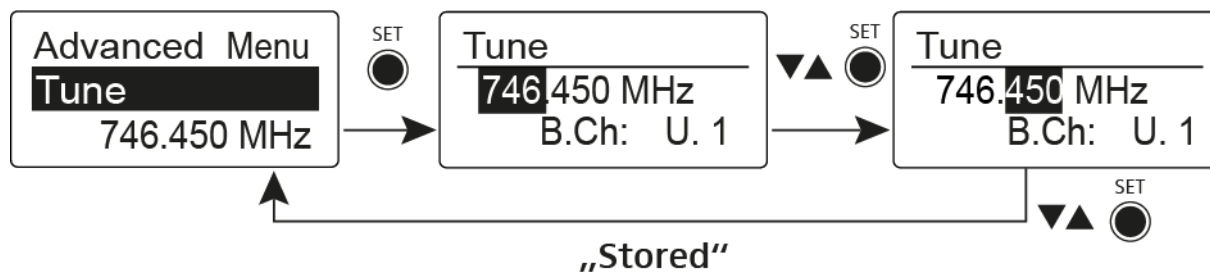

Setting the channel and frequency

- ▷ Select the menu item and call it up by holding down the **SET** button until the channel selection appears.

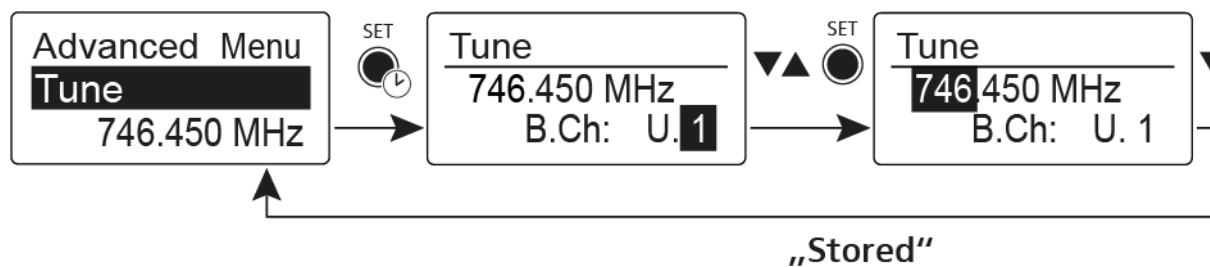

Advanced -> Pilot Tone menu item

In the **Pilot Tone** menu item of the **Advanced** submenu, you can activate and deactivate the pilot tone evaluation.

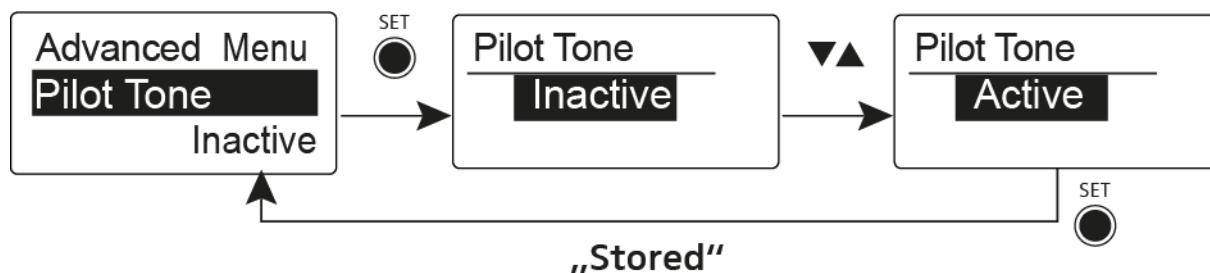

The pilot tone has an inaudible frequency that is sent from the transmitter and evaluated by the receiver. It supports the receiver's squelch function.



Advanced -> LCD Contrast menu item

In the **LCD Contrast** menu item of the **Advanced** submenu, you can adjust the display contrast of the display panel in 16 steps.

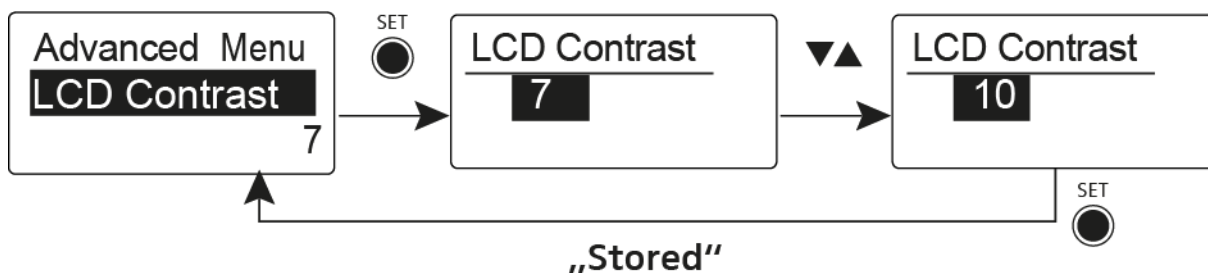

Advanced -> Reset menu item

In the **Reset** menu item of the **Advanced** submenu, you can reset the settings of the receiver.

When you reset the diversity receiver, only the selected settings of the pilot tone and the **U** frequency bank are retained.

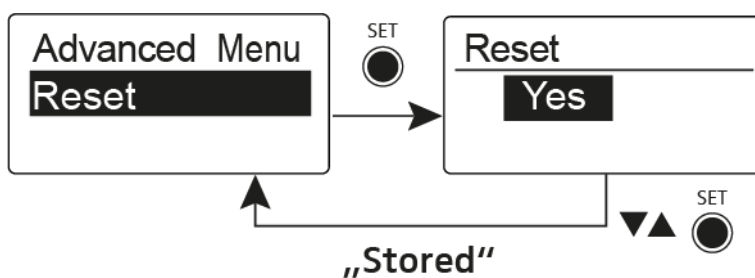

Advanced -> Software Revision menu item

In the **Software Revision** menu item of the **Advanced** submenu, you can display the current software version of the receiver.



Using the SKM 100 G4

These sections contain detailed information about using the SKM 100 G4 and SKM 100 G4-S.

You can find information on installation and startup of the SKM 100 G4 and SKM 100 G4-S under “Installing the SKM 100 G4”.



Operating elements of the SKM 100 G4 handheld transmitter

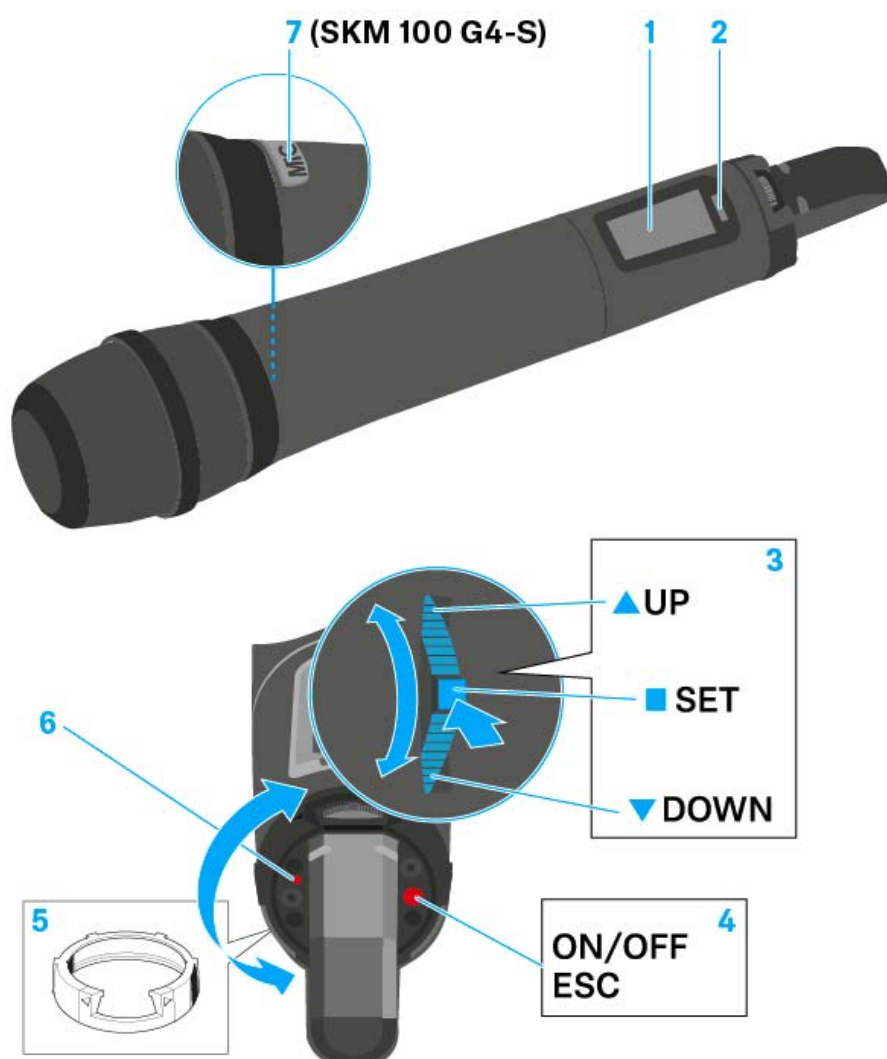

- 1** Display panel
 - See “Displays on the SKM 100 G4 handheld transmitter display panel”
- 2** Infra-red interface
 - See “Synchronizing devices”
- 3** **DOWN**, **UP** and **SET** multi-function switch
 - See “Buttons for navigating the SKM 100 G4 menu”
- 4** **ON/OFF** button with **ESC** function in the operating menu
 - Switch the transmitter on or off
See “Switching the SKM 100 G4 handheld transmitter on and off”
 - Escape function in the menu
See “Buttons for navigating the SKM 100 G4 menu”
- 5** Colored ring
 - Available in different colors (see “Additional accessories” and “Changing the colored ring”)
 - Can be turned to protect the multi-function switch



- 6** Operation and battery indicator, red LED
- illuminated = ON
See “Switching the SKM 100 G4 handheld transmitter on and off”
 - flashing = LOW BATTERY
See “Inserting and removing the batteries/rechargeable batteries”
- 7** **MIC** button (only SKM 100 G4-S)
- See “Muting the handheld transmitter (AF mute)”
 - See “Advanced > Mute Mode menu item (SKM 100 G4-S only)”

Switching the SKM 100 G4 handheld transmitter on and off

To switch on the SKM 100 G4:

- Hold down the **ON/OFF** button until the Sennheiser logo appears on the display.

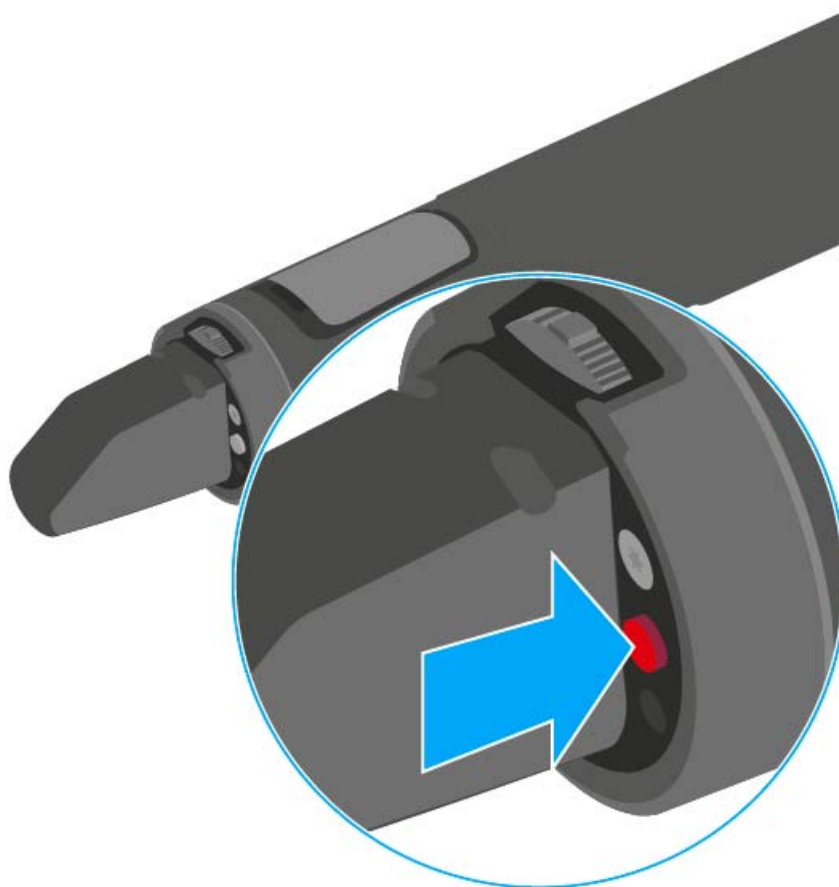

To switch off the SKM 100 G4:

- Hold down the **ON/OFF** button until the display goes off.



Muting the handheld transmitter (AF mute)

SKM 100 G4

The audio signal of the transmitter cannot be muted.

However, when you deactivate the RF signal no AF signal is output. See “Deactivating the RF signal (RF mute)”.

SKM 100 G4-S

You can mute the audio signal by pressing the **MIC** button.



- The **MIC** button lights up red: the audio signal is activated
- The **MIC** button is not lit: the audio signal is muted



Deactivating the RF signal (RF mute)

You can temporarily deactivate the RF signal when the microphone is switched on. When the RF signal is deactivated, no audio signal is output.

Use this function to save battery or when you want to prepare a microphone for use during live broadcast without interfering with the current transmission path.

To **deactivate** the RF signal:

- ▷ Short-press the **ON/OFF** button.
RF Mute On? appears.
- ▷ Press the **SET** button.

The transmission frequency is displayed, however the wireless microphone is not transmitting an RF signal. The transmission icon is not lit (see “Displays on the SKM 100 G4 handheld transmitter display panel”).

To **activate** the RF signal:

- ▷ Short-press the **ON/OFF** button.
RF Mute Off? appears.
- ▷ Press the **SET** button.

The transmission icon appears again (see “Displays on the SKM 100 G4 handheld transmitter display panel”).

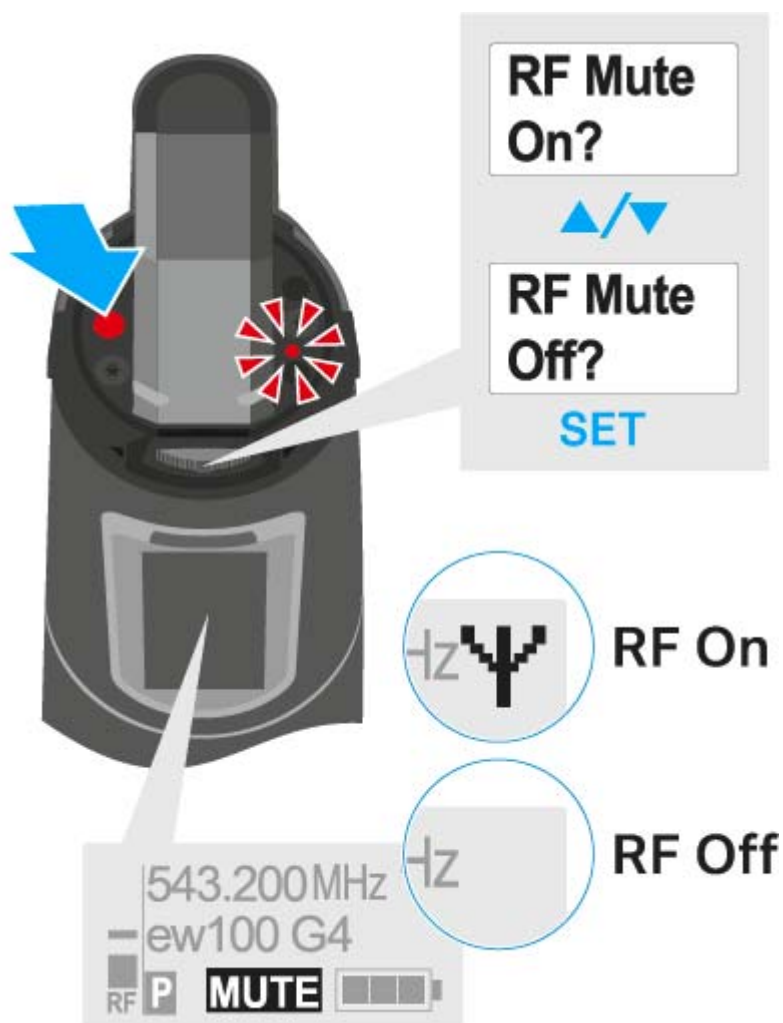



Lock-off function

You can set the automatic lock-off function in the **Auto lock** menu (see “Buttons for navigating the SKM 100 G4 menu”).

When you have switched on the lock-off function, you will have to turn the transmitter off and on again in order to operate it.

To temporarily deactivate the lock-off function:

- ▷ Press the **SET** button.
Locked appears in the display panel.
- ▷ Press the **UP** or **DOWN** button.
Unlock? appears in the display panel.
- ▷ Press the **SET** button.
Lock-off function is now temporarily deactivated.

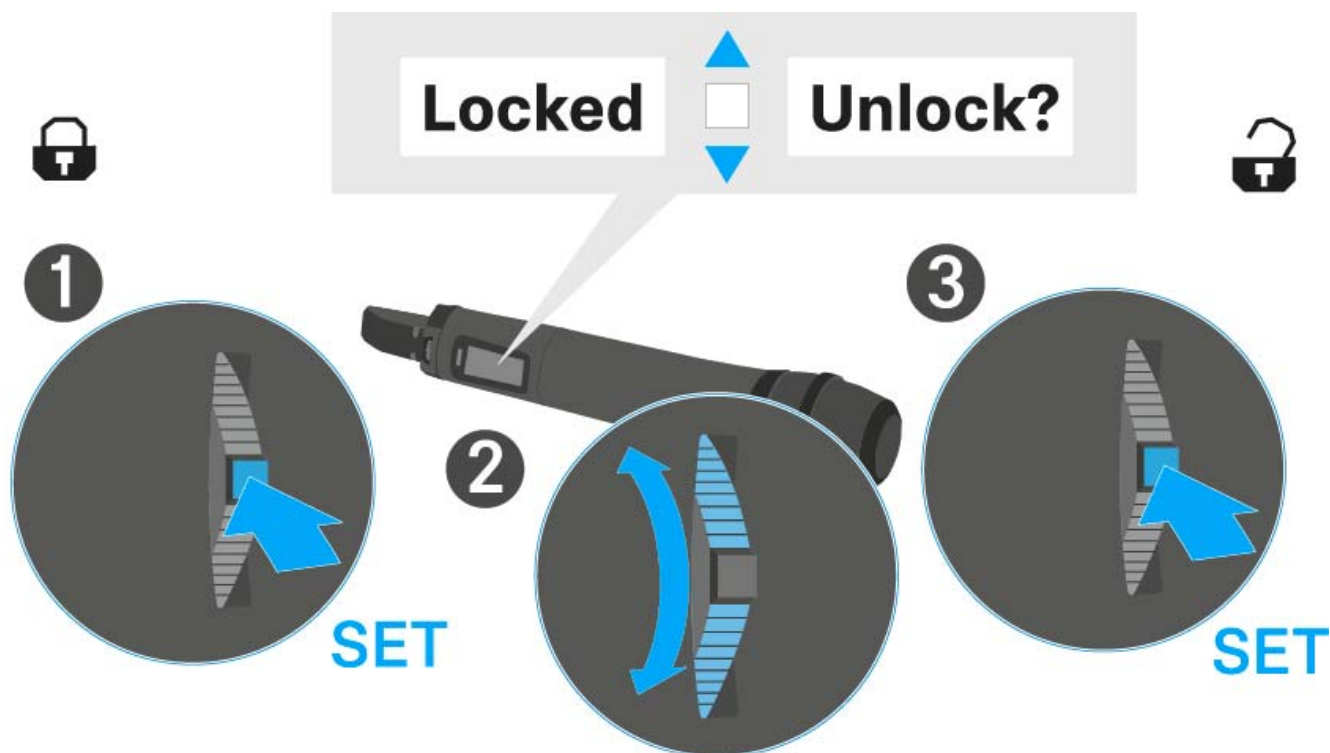



Displays on the SKM 100 G4 handheld transmitter display panel

You can view the following information on the transmitter display.

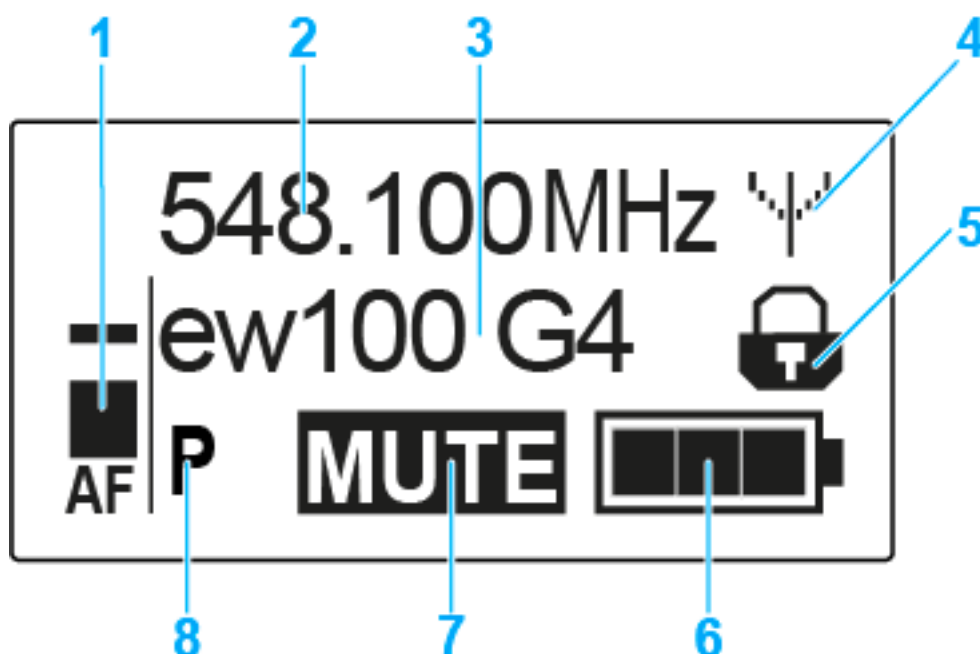

- 1 AF audio level**
 - Displays the audio level with peak hold function
 - See “Sensitivity menu item”
- 2 Frequency**
 - Configured transmission frequency
 - See “Frequency Preset menu item”
- 3 Name**
 - Freely selectable name of the receiver
 - See “Name menu item”
- 4 Transmission icon**
 - RF signal is being transmitted
 - See “Deactivating the RF signal (RF mute)”
- 5 Lock-off function**
 - Lock-off function is activated
 - See “Auto Lock menu item”
- 6 Battery status**
 - See “Battery status”
- 7 MUTE muting function**
 - The audio signal is muted
 - See “Muting the handheld transmitter (AF mute)”
 - See “Deactivating the RF signal (RF mute)”
- 8 P pilot tone**
 - Pilot tone transmission is activated
 - See “Advanced > Pilot Tone menu item”



>> “Buttons for navigating the SKM 100 G4 menu”

>> “Setting options in the menu”

Select a standard display

▷ Move the **multi-function switch** to select a standard display:

Frequency/Name standard display



Channel/Frequency standard display



Name/Channel standard display





Buttons for navigating the SKM 100 G4 menu

Navigating through the menu

To open the menu:

- ▷ Press the **SET** button.
The operating menu is shown on the transmitter display panel.

To open a menu item:

- ▷ Press the **UP** or **DOWN** buttons to navigate through the individual menu items.
- ▷ Press the **SET** button to open the selected menu item.



“Operating elements of the SKM 100 G4 handheld transmitter”

Making changes in a menu item

After you open a menu item, you can make changes as follows:

- ▷ Press the **UP** or **DOWN** buttons to set the displayed value.
- ▷ Press the **SET** button to save the setting.
- ▷ Press the **ESC (ON/OFF)** button to leave the menu item without saving the setting.



“Operating elements of the SKM 100 G4 handheld transmitter”

>> “Displays on the SKM 100 G4 handheld transmitter display panel”

>> “Setting options in the menu”



Setting options in the menu

In the SKM 100 G4 menu, you can configure the following settings.

Adjusting the input sensitivity

- ▷ See “Sensitivity menu item”

Setting the frequency bank and the channel

- ▷ See “Frequency Preset menu item”

Entering a freely selectable name

- ▷ See “Name menu item”

Activating/deactivating the automatic lock-off function

- ▷ See “Auto Lock menu item”

Configuring enhanced settings in the **Advanced Menu**:

- Adjusting the transmission frequencies for the U frequency bank
 - Defining the MIC button setting (SKM 100 G4-S only)
 - Activating/deactivating the pilot tone evaluation
 - Adjusting the contrast of the display panel
 - Resetting the transmitter
 - Displaying the current software revision
 - ▷ See “Advanced menu item”
-



Sensitivity menu item

- Adjusting the input sensitivity – **AF** audio level

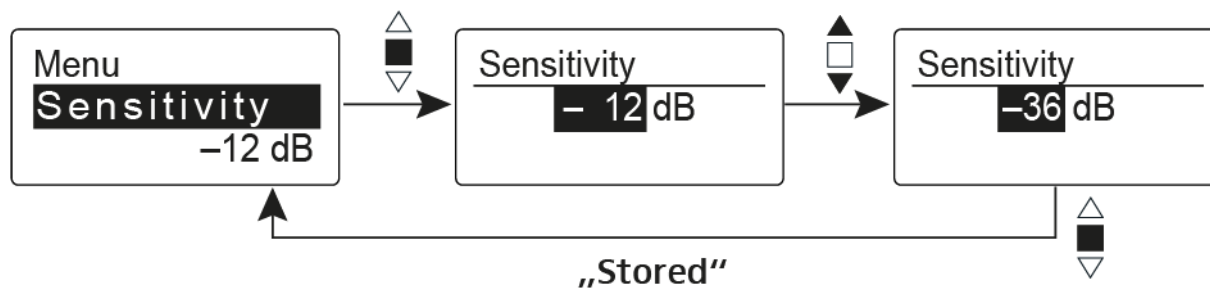

Setting range: 0 dB to -48 dB in 6 dB steps.

The **AF** audio level is also displayed when the wireless microphone is muted, e.g. to check the sensitivity before a live broadcast.

Recommended presets:

- Loud music/vocals: -48 to -18 dB
- Moderation: -18 to -12 dB
- Interviews: -12 to 0 dB



Frequency Preset menu item

- Manually selecting a frequency bank and channel

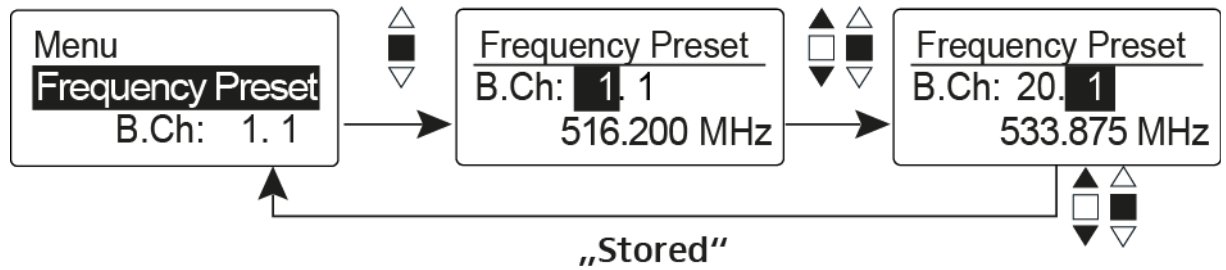

While you work in the Frequency Preset menu, the RF signal is deactivated.

Please note when creating multi-channel systems:

Only the factory-preset frequencies within one frequency bank are intermodulation-free. The wireless microphone and receiver must be set to the same frequency. Be sure to note the information on frequency selection under “Establishing a radio link”.

Name menu item

- Entering names

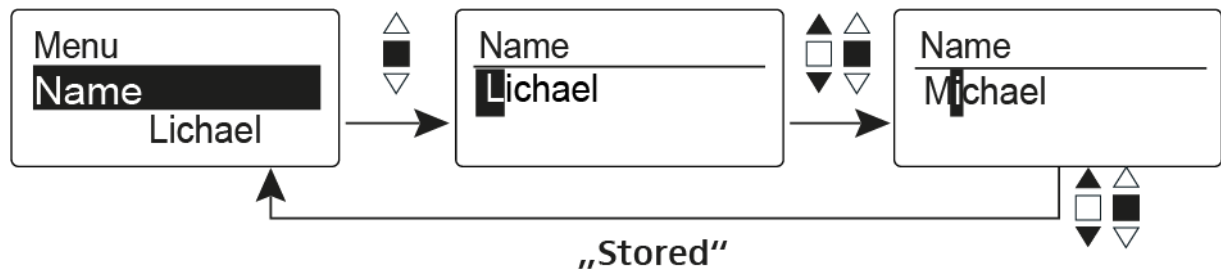

In the **Name** menu item you can enter any name you want for the wireless microphone (e.g. the names of the musicians).

The name can be shown in the [Frequency/Name](#) and [Name/Channel](#) standard displays.

The names are a maximum of 8 characters:

- All letters except umlauts.
- Numbers from 0 to 9
- Special characters and spaces

Enter the names as follows:

- ▷ Move the multi-function switch to select a character.
- ▷ Press the multi-function switch to jump to the next space or to save the name you have entered once it is complete.



Auto Lock menu item

- Switching the automatic lock-off function on and off

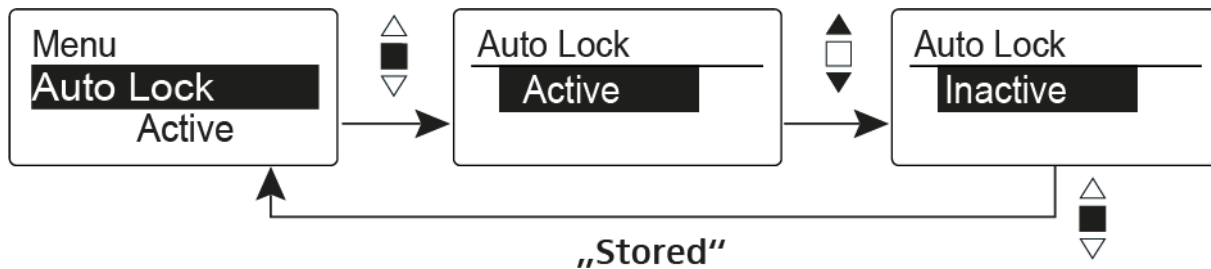

This lock prevents the wireless microphone from being unintentionally switched off and also prevents any unintentional changes to the transmitter's configuration. In the current standard display, the lock icon shows whether the lock-off function is currently switched on.

You can find information about using the lock-off function under "Lock-off function".



Advanced menu item

In the **Advanced** submenu you can configure enhanced settings.

The following sub-items are available:

Adjusting the transmission frequencies for the U frequency bank

- ▷ See “Advanced > Tune menu item”

Defining the MIC button setting (SKM 100 G4-S only)

- ▷ See “Advanced > Mute Mode menu item (SKM 100 G4-S only)”

Activating/deactivating the pilot tone evaluation

- ▷ See “Advanced > Pilot Tone menu item”

Adjusting the contrast of the display panel

- ▷ See “Advanced > LCD Contrast menu item”

Resetting the transmitter

- ▷ See “Advanced > Reset menu item”

Displaying the current software revision

- ▷ See “Advanced > Software Revision menu item”
-



Advanced > Tune menu item

- Configuring the transmission frequency and frequency bank U

When you have configured the wireless microphone to a system bank and you call up the **Tune** menu item, channel 1 of the frequency bank **U** is automatically set. The message **U.1** briefly appears in the display. In the factory settings, the channels of the frequency bank **U** are not assigned to any transmission frequency.

While you work in the **Tune** menu, the RF signal is deactivated.

You can configure a transmission frequency for the current channel or select a channel in the frequency bank **U** and configure a transmission frequency for this channel in the **Tune** menu. Be sure to note the information on frequency selection, see “Setting notes”.

Only adjusting the frequency

To configure the transmission frequency for the current channel:

- ▷ Open the **Tune** menu item in the **Advanced** menu.

The frequency selection appears.

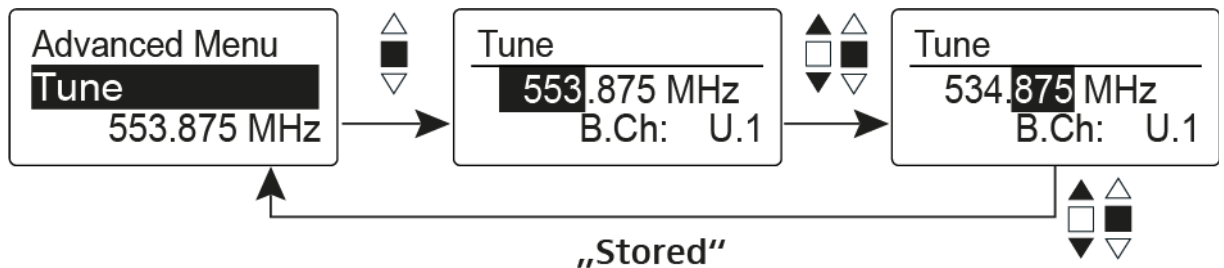

- ▷ Configure the desired frequency.
- ▷ Press the multi-function switch.
Your settings will be saved. You are now back in the operating menu.

Setting the channel and frequency

To select a **channel** and assign it a frequency:

- ▷ Move the multi-function switch until the **Tune** menu item appears.
- ▷ Hold down the multi-function switch until the frequency bank selection appears.

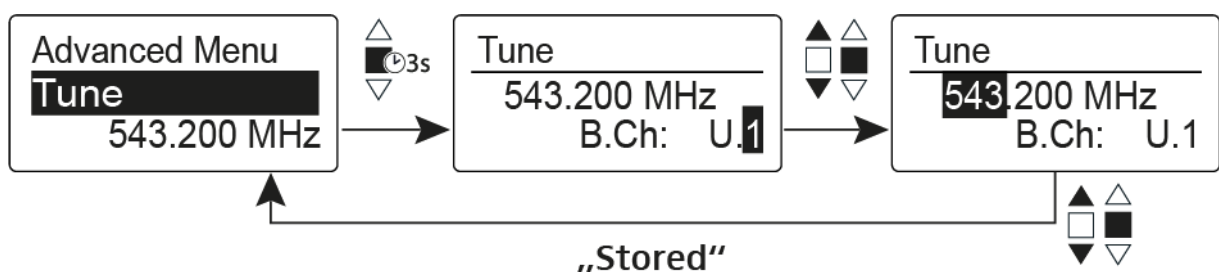

- ▷ Set the desired channel.
- ▷ Press the multi-function switch.
The frequency selection appears.
- ▷ Configure the frequency.



Advanced > Mute Mode menu item (SKM 100 G4-S only)

- Configuring the function of the **MIC** button

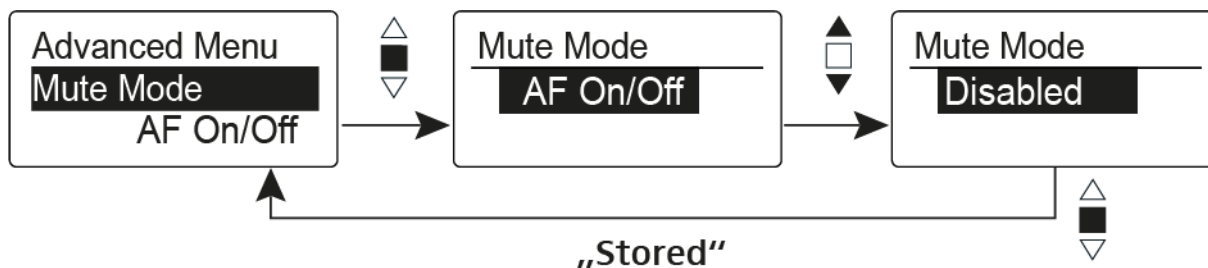

AF On/Off mode

- When you press the **MIC** button, no audio signal is transmitted.

Disabled mode

- No function

You can find information about the **MIC** button under “Muting the handheld transmitter (AF mute)”.

Advanced > Pilot Tone menu item

- Activating/deactivating pilot tone transmission

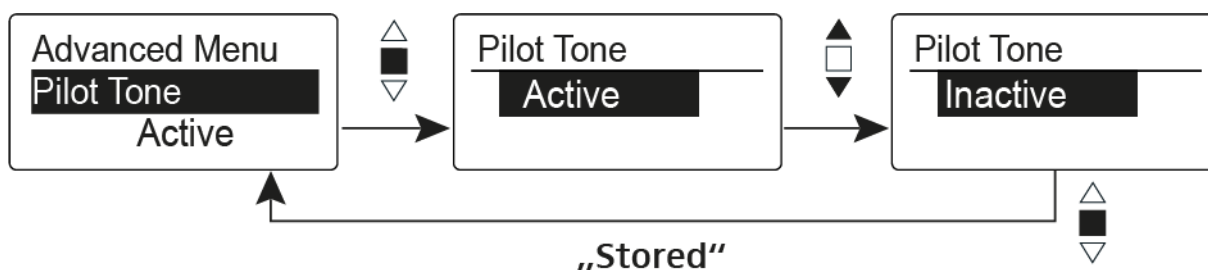

The pilot tone has an inaudible frequency that is sent from the transmitter and evaluated by the receiver. It supports the receiver’s squelch function.

Advanced > LCD Contrast menu item

- Adjusting the contrast of the display panel

You can configure the contrast of the display in 16 steps.



Advanced > Reset menu item

- Resetting the wireless microphone

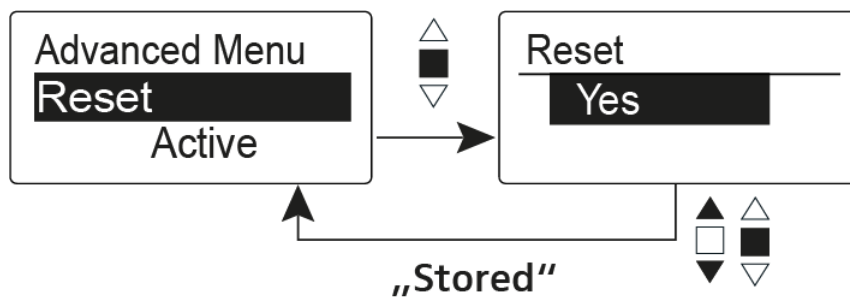

When you reset the wireless microphone, only the selected settings of the pilot tone and the **U** frequency bank are retained.

Advanced > Software Revision menu item

- Show software revision

You can display the current software revision.



Using the SK 100 G4

These sections contain detailed information about using the SK 100 G4.

You can find information on installation and startup of the SK 100 G4 under “Installing the SK 100 G4”.



Operating elements of the SK 100 G4 bodypack transmitter



- 1** Display panel
 - See “Displays on the SK 100 G4 bodypack transmitter display panel”
- 2** Operation and battery indicator, red LED
 - illuminated = ON
See “Switching the SK 100 G4 bodypack transmitter on and off”
 - flashing = LOW BATTERY
See “Inserting and removing the batteries/rechargeable batteries”
- 3** Audio overload indicator, yellow LED
 - illuminated = AF PEAK (overload)
See “Sensitivity menu item”
- 4** UP button
 - See “Buttons for navigating the SK 100 G4 menu”
- 5** SET button
 - See “Buttons for navigating the SK 100 G4 menu”
- 6** DOWN button
 - See “Buttons for navigating the SK 100 G4 menu”



7 **ON/OFF** button with ESC function in the operating menu

- Switch the transmitter on or off
See “Switching the SK 100 G4 bodypack transmitter on and off”
- Escape function in the menu
See “Buttons for navigating the SK 100 G4 menu”

8 Infra-red interface

- See “Synchronizing devices”

9 **MUTE** switch

- Deactivate and activate audio signal
See “Muting the bodypack transmitter (AF mute)”
- Deactivate and activate RF signal
See “Deactivating the RF signal (RF mute)”

Switching the SK 100 G4 bodypack transmitter on and off

- ▷ Press the two catches and open the battery compartment cover.

To switch on the SK 100 G4:

- ▷ Hold down the **ON/OFF** button until the Sennheiser logo appears on the display.

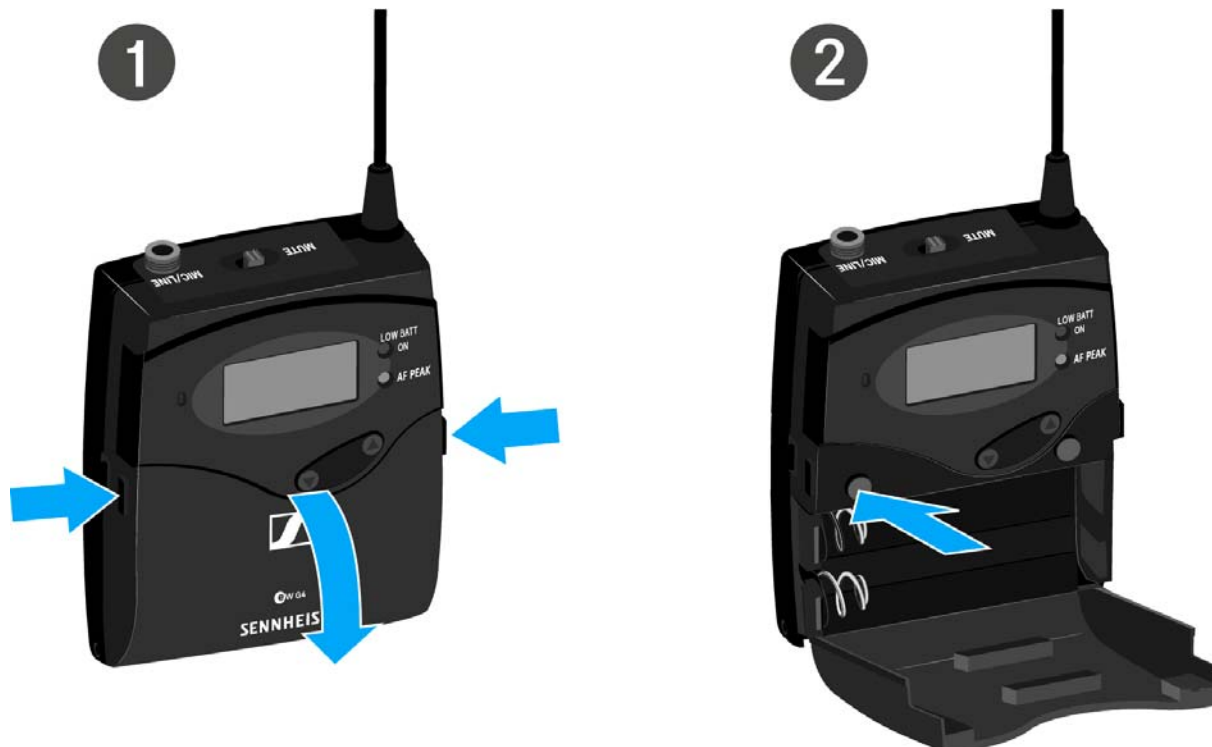

To switch off the SK 100 G4:

- ▷ Hold down the **ON/OFF** button until the display goes off.



Muting the bodypack transmitter (AF mute)

You can deactivate the audio signal with the **MUTE** switch.

To do this, the **MUTE** switch function must be configured to **AF On/Off**. You can find more information about this subject under “Advanced > Mute Mode menu item”.



- ▷ Slide the **MUTE** switch to the **MUTE** position.
The audio signal is muted. The message **MUTE** is shown on the display.



Deactivating the RF signal (RF mute)

You can deactivate the RF signal in two ways:

Deactivating the RF signal with the **MUTE** switch

You can deactivate the RF signal with the **MUTE** switch.

To do this, the **MUTE** switch function must be configured to **RF On/Off**. You can find more information about this subject under “Advanced > Mute Mode menu item”.





- ▶ Slide the **MUTE** switch to the **MUTE** position.
The RF signal is deactivated. The message **MUTE** is shown in the display and the transmission icon no longer appears.





Deactivating the RF signal with the **ON/OFF** button

You can deactivate the RF signal with the **ON/OFF** button.

To deactivate the RF signal:

- ▷ Short-press the **ON/OFF** button.
RF Mute On? appears.
- ▷ Press the **SET** button.

The RF signal is deactivated. The message MUTE is shown in the display and the transmission icon no longer appears.



To activate the RF signal:

- ▷ Short-press the **ON/OFF** button.
RF Mute Off? appears.
- ▷ Press the **SET** button.
The transmission icon appears again.



Lock-off function

You can set the automatic lock-off function in the **Auto lock** menu (see “Buttons for navigating the SK 100 G4 menu”).

When you have switched on the lock-off function, you will have to turn the transmitter off and on again in order to operate it.

To temporarily deactivate the lock-off function:

- ▷ Press the **SET** button.
Locked appears in the display panel.
- ▷ Press the **UP** or **DOWN** button.
Unlock? appears in the display panel.
- ▷ Press the **SET** button.
Lock-off function is now temporarily deactivated.

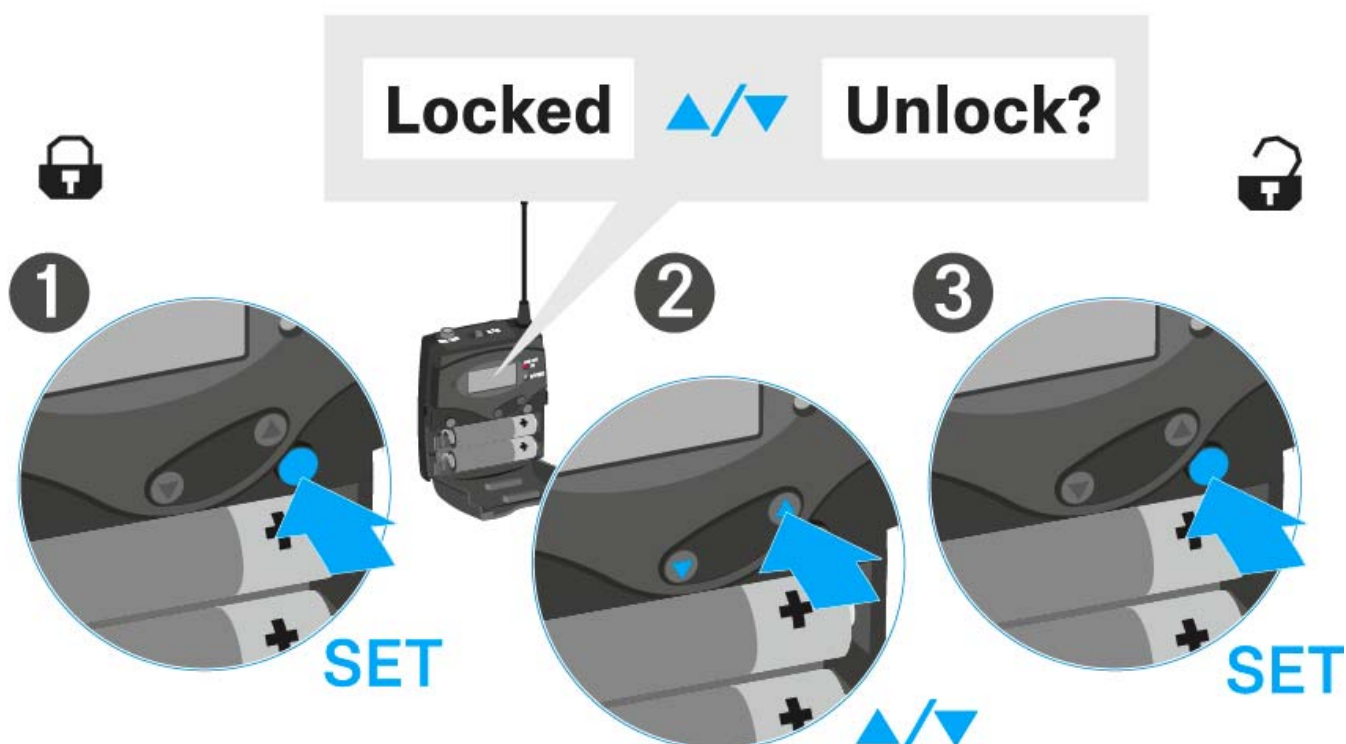



Displays on the SK 100 G4 bodypack transmitter display panel

You can view the following information on the transmitter display.

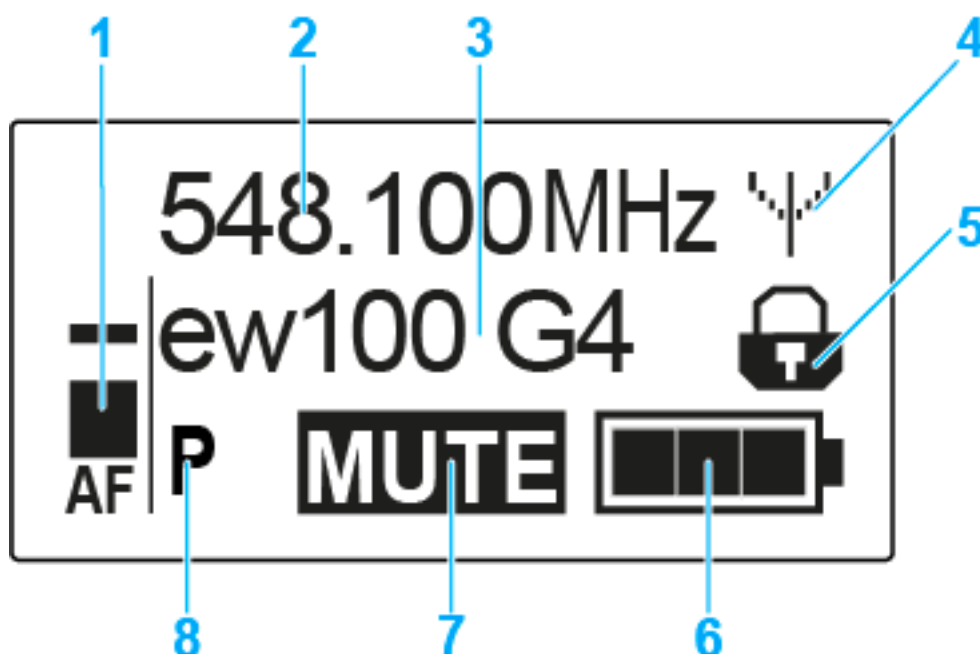

- 1 AF** audio level
 - Displays the audio level with peak hold function
 - See “Sensitivity menu item”
- 2** Frequency
 - Configured transmission frequency
 - See “Frequency Preset menu item”
- 3** Name
 - Freely selectable name of the receiver
 - See “Name menu item”
- 4** Transmission icon
 - RF signal is being transmitted
 - See “Deactivating the RF signal (RF mute)”
- 5** Lock-off function
 - Lock-off function is activated
 - See “Auto Lock menu item”
- 6** Battery status
 - See “Battery status”
- 7 MUTE** muting function
 - The audio signal is muted
 - See “Muting the bodypack transmitter (AF mute)”
 - See “Deactivating the RF signal (RF mute)”
- 8 P** pilot tone
 - Pilot tone transmission is activated
 - See “Advanced > Pilot Tone menu item”



>> “Buttons for navigating the SK 100 G4 menu”

>> “Setting options in the menu”

Select a standard display

▷ Press the **UP** or **DOWN** buttons to select a standard display.

Frequency/Name standard display



Channel/Frequency standard display



Name/Channel standard display

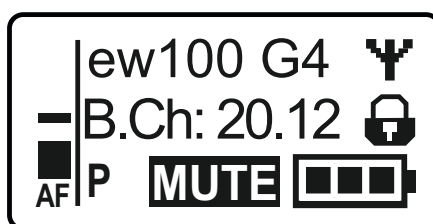



Buttons for navigating the SK 100 G4 menu

Navigating through the menu

To open the menu:

- ▷ Press the **SET** button.
The operating menu is shown on the transmitter display panel.

To open a menu item:

- ▷ Press the **UP** or **DOWN** buttons to navigate through the individual menu items.
- ▷ Press the **SET** button to open the selected menu item.



“Operating elements of the SK 100 G4 bodypack transmitter”

Making changes in a menu item

After you open a menu item, you can make changes as follows:

- ▷ Press the **UP** or **DOWN** buttons to set the displayed value.
- ▷ Press the **SET** button to save the setting.
- ▷ Press the **ESC (ON/OFF)** button to leave the menu item without saving the setting.



“Operating elements of the SK 100 G4 bodypack transmitter”

>> “Displays on the SK 100 G4 bodypack transmitter display panel”

>> “Setting options in the menu”



Setting options in the menu

In the SK 100 G4 menu, you can configure the following settings.

Adjusting the input sensitivity

- ▷ See “Sensitivity menu item”

Setting the frequency bank and the channel

- ▷ See “Frequency Preset menu item”

Entering a freely selectable name

- ▷ See “Name menu item”

Activating/deactivating the automatic lock-off function

- ▷ See “Auto Lock menu item”

Configuring enhanced settings in the **Advanced Menu**:

- Adjusting the transmission frequencies for the U frequency bank
 - Configuring the MUTE switch
 - Configuring the guitar cable emulation
 - Activating/deactivating the pilot tone evaluation
 - Adjusting the contrast of the display panel
 - Resetting the transmitter
 - Displaying the current software revision
 - ▷ See “Advanced menu item”
-



Sensitivity menu item

- Adjusting the input sensitivity – **AF** audio level

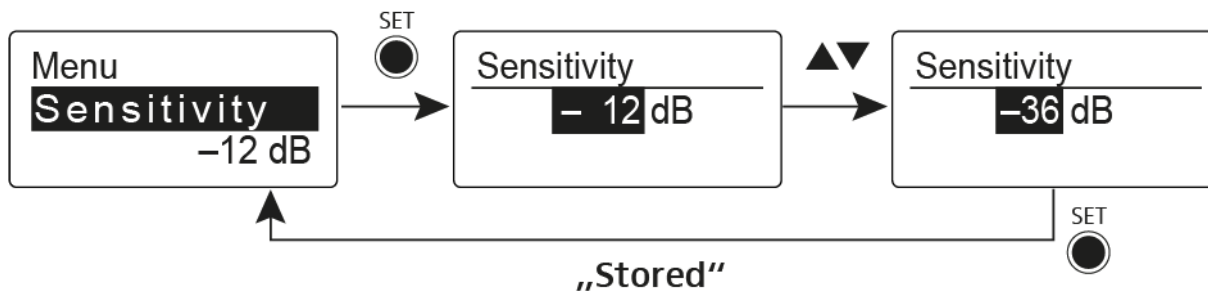

Setting range: 0 dB to -60 dB in 6 dB steps.

The **AF** audio level is also displayed when the bodypack transmitter is muted, e.g. to check the sensitivity before a live broadcast.

Recommended presets:

- Loud music/vocals: -30 to -21 dB
- Moderation: -21 to 0 dB
- Electric guitar with single-coil pickups: -30 to -24 dB
- Electric guitar with Humbucker pickups: -45 to -30 dB
- Electric guitars with active electronics: -45 to -30 dB

Frequency Preset menu item

- Manually selecting a frequency bank and channel

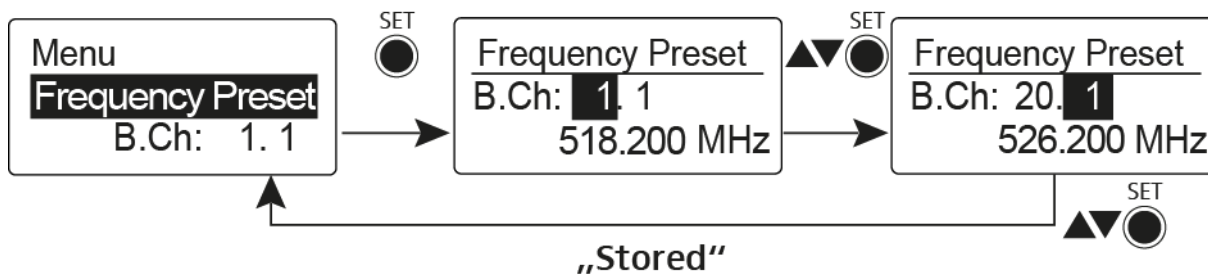

i While you work in the Frequency Preset menu, the RF signal is deactivated.

Please note when creating multi-channel systems:

Only the factory-preset frequencies within one frequency bank are intermodulation-free. The bodypack transmitter and receiver must be set to the same frequency. Be sure to note the information on frequency selection under “Establishing a radio link”.



Name menu item

- Entering names

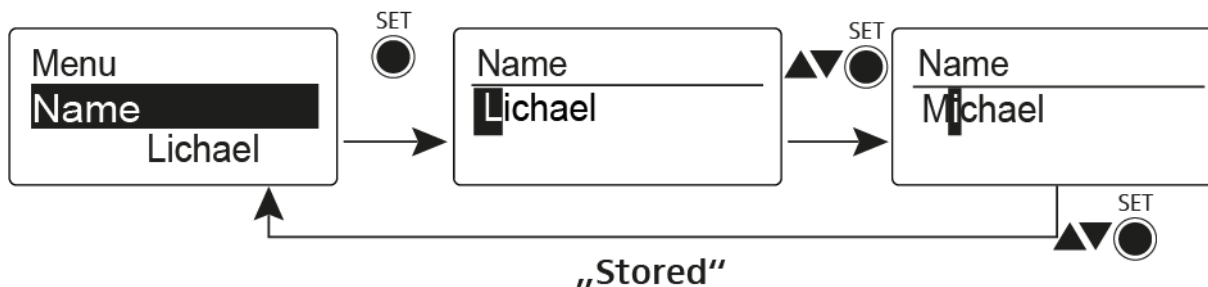

In the **Name** menu item you can enter any name you want for the bodypack transmitters (e.g. the names of the musicians).

The name can be shown in the [Frequency/Name](#) and [Name/Channel](#) standard displays.

The names are a maximum of 8 characters:

- All letters except umlauts.
- Numbers from 0 to 9
- Special characters and spaces

Enter the names as follows:

- ▷ Press the **UP** or **DOWN** buttons to select a character.
- ▷ Press the **SET** button to switch to the next space or to save the name you have entered once it is complete.

Auto Lock menu item

- Switching the automatic lock-off function on and off

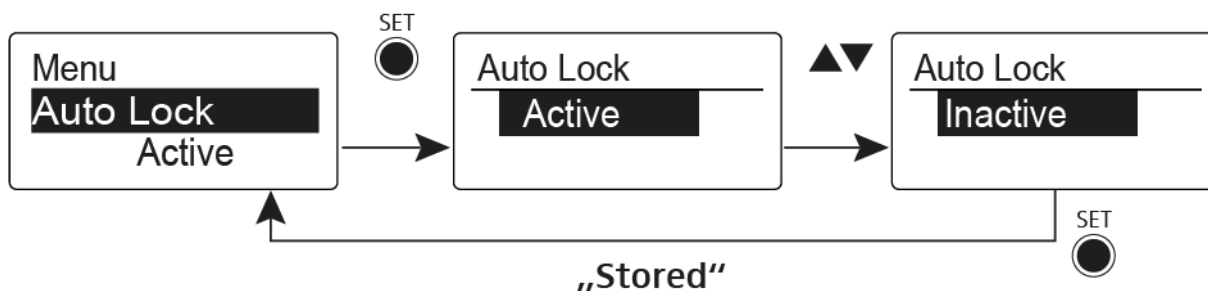

This lock prevents the wireless microphone from being unintentionally switched off and also prevents any unintentional changes to the transmitter's configuration. In the current standard display, the lock icon shows whether the lock-off function is currently switched on.

You can find information about using the lock-off function under "Lock-off function".



Advanced menu item

In the **Advanced** submenu you can configure enhanced settings.

The following sub-items are available:

Adjusting the transmission frequencies for the U frequency bank

- ▷ See “Advanced > Tune menu item”

Configuring the MUTE switch

- ▷ See “Advanced > Mute Mode menu item”

Configuring the guitar cable emulation

- ▷ See “Advanced > Cable Emulation menu item”

Activating/deactivating the pilot tone evaluation

- ▷ See “Advanced > Pilot Tone menu item”

Adjusting the contrast of the display panel

- ▷ See “Advanced > LCD Contrast menu item”

Resetting the transmitter

- ▷ See “Advanced > Reset menu item”

Displaying the current software revision

- ▷ See “Advanced > Software Revision menu item”
-



Advanced > Tune menu item

- Configuring the transmission frequency and frequency bank U

When you have configured the bodypack transmitter to a system bank and you call up the **Tune** menu item, channel 1 of the frequency bank **U** is automatically set. The message **U.1** briefly appears in the display. In the factory settings, the channels of the frequency bank **U** are not assigned to any transmission frequency.

While you work in the **Tune** menu, the RF signal is deactivated.

You can configure a transmission frequency for the current channel or select a channel in the frequency bank **U** and configure a transmission frequency for this channel in the **Tune** menu. Be sure to note the information on frequency selection, see “Setting notes”.

Only adjusting the frequency

To configure the transmission frequency for the current channel:

- ▷ Open the **Tune** menu item in the **Advanced** menu.
The frequency selection appears.

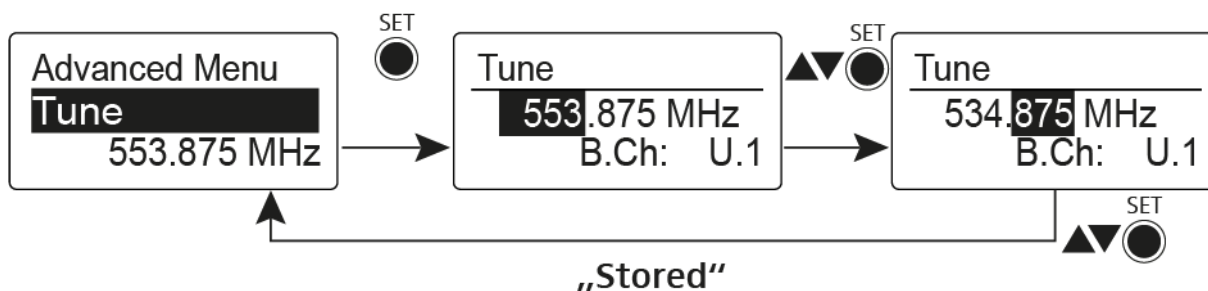

- ▷ Configure the desired frequency.
- ▷ Press the **SET** button.
Your settings will be saved. You are now back in the operating menu.

Setting the channel and frequency

To select a **channel** and assign it a frequency:

- ▷ Open the **Tune** menu item in the **Advanced** menu by pressing and holding the **SET** button until the frequency bank selection appears.

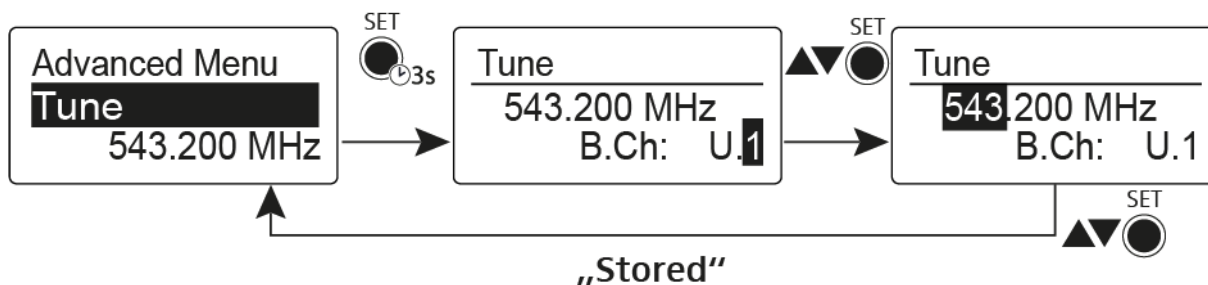

- ▷ Set the desired channel.
- ▷ Press the **SET** button.
The frequency selection appears.
- ▷ Configure the frequency.



Advanced > Mute Mode menu item

- Configuring the **MUTE** switch

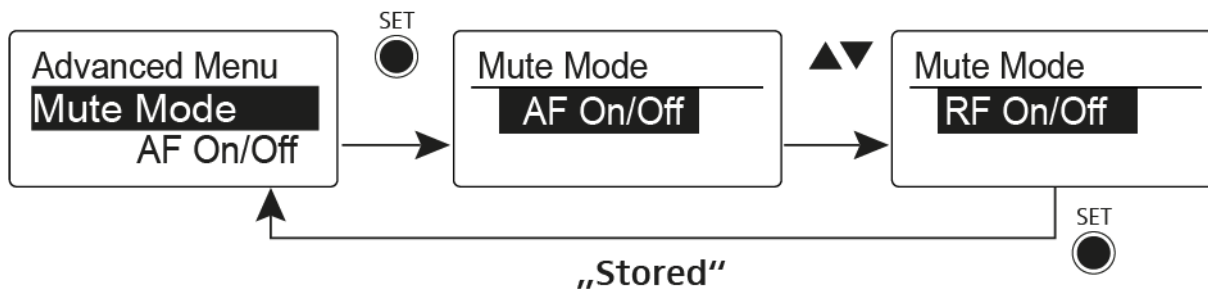

AF On/Off mode

- If set to position MUTE, the audio signal is muted.

RF On/Off mode

- If set to position MUTE, the RF signal is deactivated.

Disabled mode

- No function

You can find information about operating the mute switch under “Muting the bodypack transmitter (AF mute)” and “Deactivating the RF signal (RF mute)”.

Advanced > Cable Emulation menu item

- Emulating a guitar cable

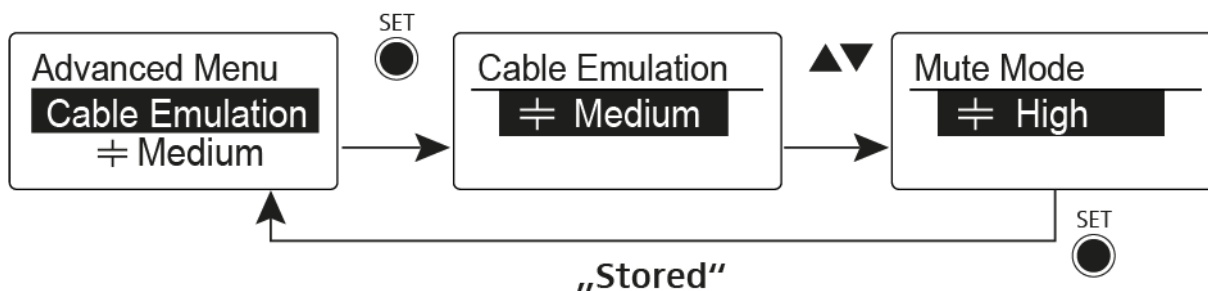

Using this menu item you can emulate the capacitances of your guitar cables and influence the sound of your guitar.



Advanced > Pilot Tone menu item

- Activating/deactivating pilot tone transmission

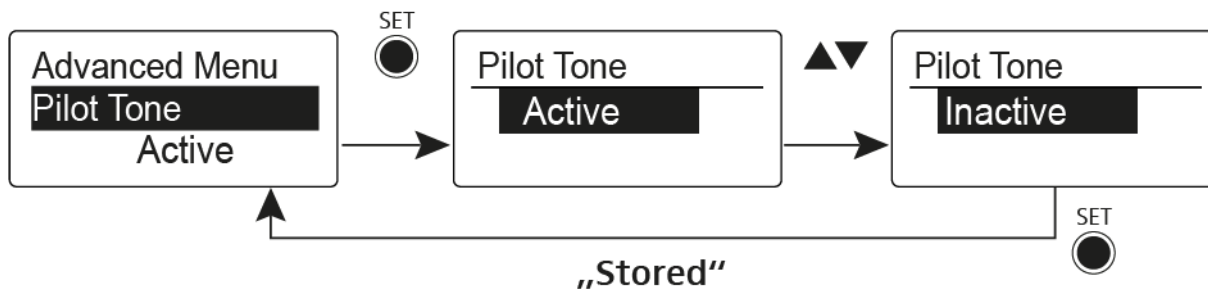

The pilot tone has an inaudible frequency that is sent from the transmitter and evaluated by the receiver. It supports the receiver's squelch function.

Advanced > LCD Contrast menu item

- Adjusting the contrast of the display panel

You can configure the contrast of the display in 16 steps.

Advanced > Reset menu item

- Resetting the bodypack transmitter

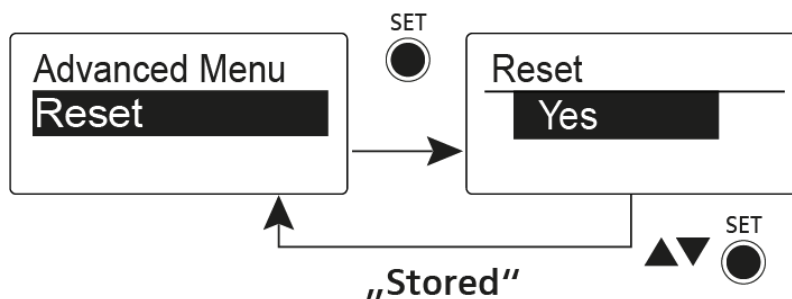

When you reset the bodypack transmitter, only the selected settings of the pilot tone and the **U** frequency bank are retained.

Advanced > Software Revision menu item

- Show software revision

You can display the current software revision.



Using the SKP 100 G4

These sections contain detailed information about using the SKP 100 G4.

You can find information on installation and startup of the SKP 100 G4 under "Installing the SKP 100 G4".



Operating elements of the SKP 100 G4 plug-on transmitter

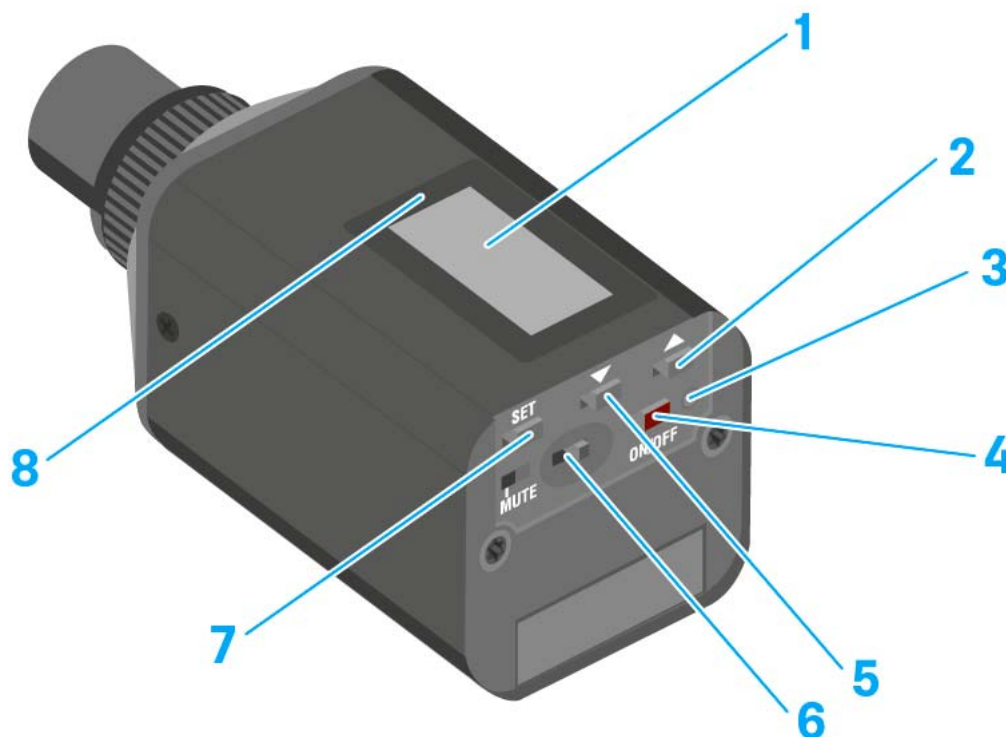

- 1** Display panel
 - See “Displays on the SKP 100 G4 plug-on transmitter display panel”
- 2** **UP** button
 - See “Buttons for navigating the SKP 100 G4 menu”
- 3** Operation and battery indicator, red LED
 - illuminated = ON
See “Switching the SKP 100 G4 plug-on transmitter on and off”
 - flashing = LOW BATTERY
See “Inserting and removing the batteries/rechargeable batteries”
- 4** **ON/OFF** button with **ESC** function in the operating menu
 - Switch the transmitter on or off
See “Switching the SKP 100 G4 plug-on transmitter on and off”
 - Escape function in the menu
See “Buttons for navigating the SKP 100 G4 menu”
- 5** **DOWN** button
 - See “Buttons for navigating the SKP 100 G4 menu”
- 6** **MUTE** switch
 - See “Muting the plug-on transmitter (AF mute)”
- 7** **SET** button
 - See “Buttons for navigating the SKP 100 G4 menu”
- 8** Infra-red interface
 - See “Synchronizing devices”



Switching the SKP 100 G4 plug-on transmitter on and off

To switch on the SKP 100 G4:

- Hold down the **ON/OFF** button until the Sennheiser logo appears on the display.



To switch off the SKP 100 G4:

- Hold down the **ON/OFF** button until the display goes off.



Muting the plug-on transmitter (AF mute)

You can mute the audio signal with the **MUTE** switch.

To do this, the **MUTE** switch function must be configured to **AF On/Off**. You can find more information about this subject under “Advanced > Mute Mode menu item”.



- ▶ Slide the **MUTE** switch to the **MUTE** position.
The audio signal is muted. The message **MUTE** is shown on the display.



Deactivating the RF signal (RF mute)

You can deactivate the RF signal in two ways:

Deactivating the RF signal with the **MUTE** switch

You can deactivate the RF signal with the MUTE switch.

To do this, the MUTE switch function must be configured to RF On/Off. You can find more information about this subject under “Advanced > Mute Mode menu item”.



Slide the **MUTE** switch to the **MUTE** position.



The RF signal is deactivated. The message **MUTE** is shown in the display and the transmission icon no longer appears.

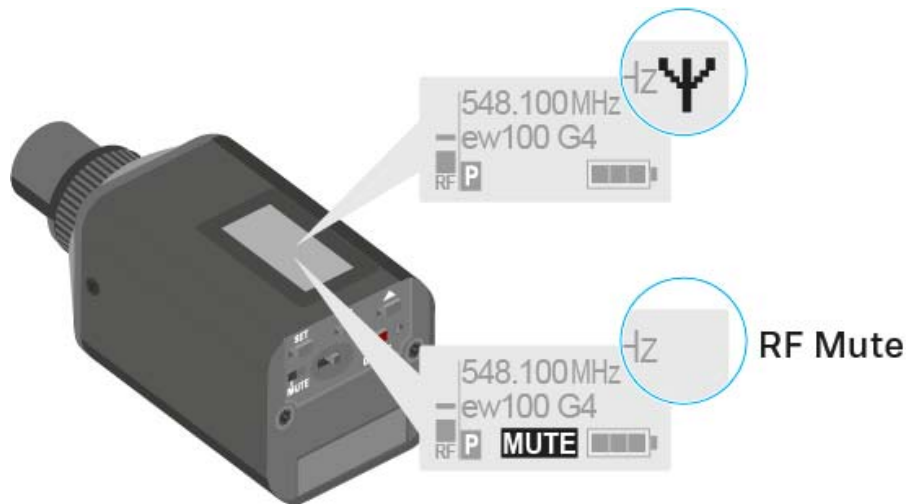

Deactivating the RF signal with the **ON/OFF** button

You can deactivate the RF signal with the ON/OFF button.

To deactivate the RF signal:

- ▷ Short-press the **ON/OFF** button.
RF Mute On? appears.
- ▷ Press the **SET** button.

The RF signal is deactivated. The message **MUTE** is shown in the display and the transmission icon no longer appears.

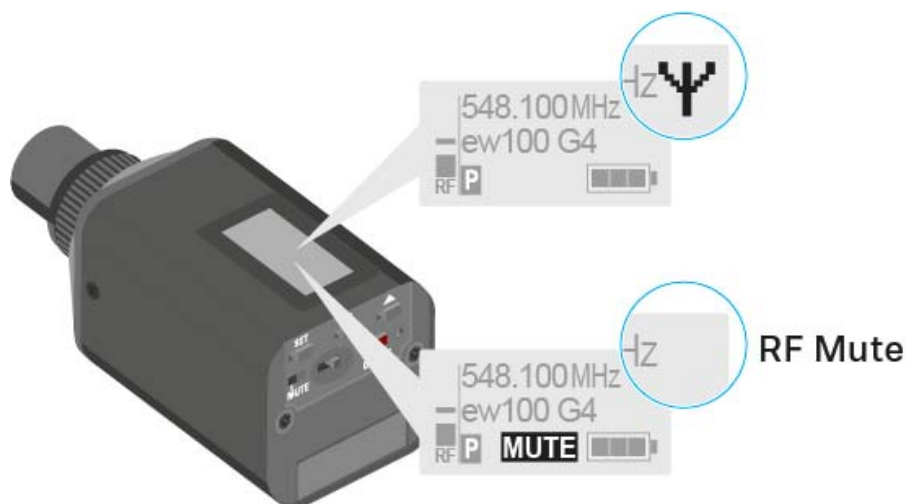

To activate the RF signal:

- ▷ Short-press the **ON/OFF** button.
RF Mute Off? appears.
- ▷ Press the **SET** button.
The transmission icon appears again.



Lock-off function

You can set the automatic lock-off function in the **Auto lock** menu (see “Auto Lock menu item”).

When you have switched on the lock-off function, you will have to turn the transmitter off and on again in order to operate it.

To temporarily deactivate the lock-off function:

- ▷ Press the **SET** button.
Locked appears in the display panel.
- ▷ Press the **UP** or **DOWN** button.
Unlock? appears in the display panel.
- ▷ Press the **SET** button.
Lock-off function is now temporarily deactivated.

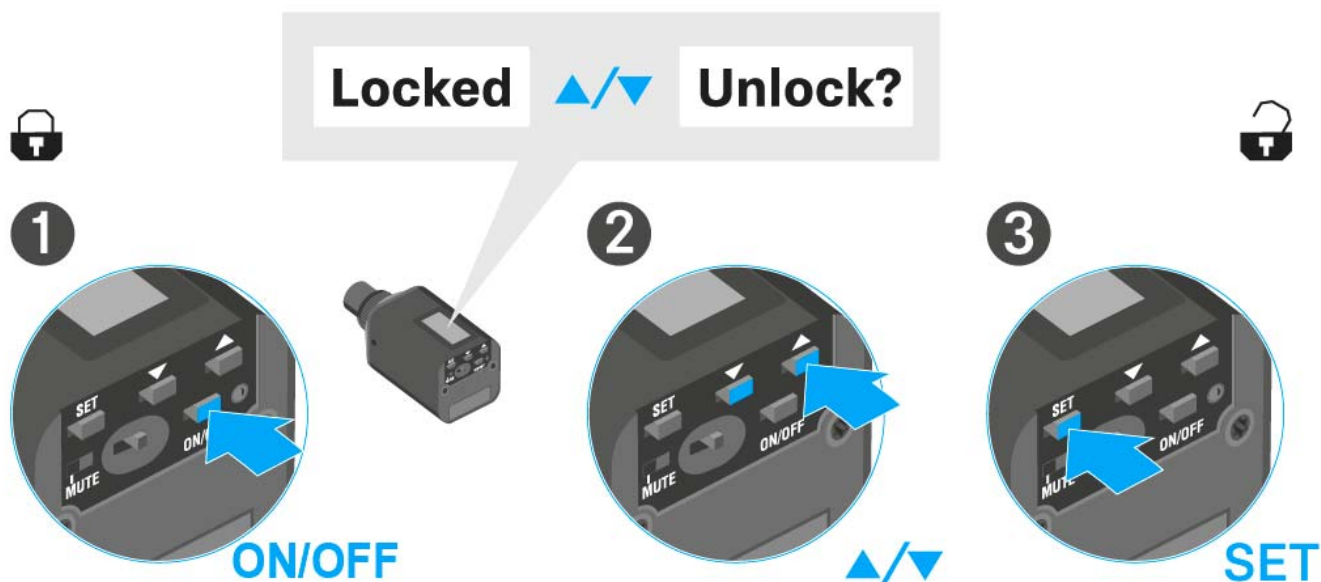

When you are in the operating menu

>> Lock-off function is deactivated long enough for you to work in the operating menu.

When one of the standard displays is shown

>> Lock-off function is automatically activated after 10 seconds.

The lock-off function icon flashes while the lock-off function is being activated again.



Displays on the SKP 100 G4 plug-on transmitter display panel

You can view the following information on the transmitter display.

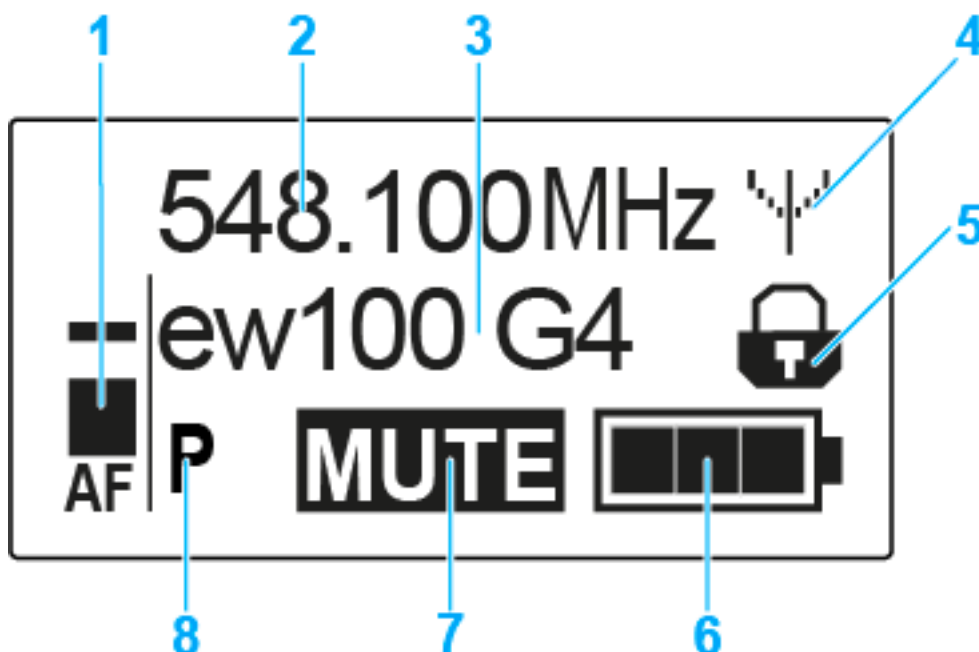

- 1 AF** audio level
 - Displays the audio level with peak hold function
 - See “Sensitivity menu item”
- 2** Frequency
 - Configured transmission frequency
 - See “Frequency Preset menu item”
- 3** Name
 - Freely selectable name of the receiver
 - See “Name menu item”
- 4** Transmission icon
 - RF signal is being transmitted
 - See “Deactivating the RF signal (RF mute)”
- 5** Lock-off function
 - Lock-off function is activated
 - See “Auto Lock menu item”
- 6** Battery status
 - See “Inserting and removing the batteries/rechargeable batteries”
- 7 MUTE** muting function
 - The audio signal is muted
 - See “Muting the plug-on transmitter (AF mute)”
- 8 P** pilot tone
 - Pilot tone transmission is activated
 - See “Advanced > Pilot Tone menu item”



>> “Buttons for navigating the SKP 100 G4 menu”

>> “Setting options in the menu”

Select a standard display

▷ Press the **UP** or **DOWN** buttons to select a standard display.

Frequency/Name standard display



Channel/Frequency standard display



Name/Channel standard display





Buttons for navigating the SKP 100 G4 menu

Navigating through the menu

To open the menu:

- ▷ Press the **SET** button.
The operating menu is shown on the transmitter display panel.

To open a menu item:

- ▷ Press the **UP** or **DOWN** buttons to navigate through the individual menu items.
- ▷ Press the **SET** button to open the selected menu item.

i “Operating elements of the SKP 100 G4 plug-on transmitter”

Making changes in a menu item

After you open a menu item, you can make changes as follows:

- ▷ Press the **UP** or **DOWN** buttons to set the displayed value.
- ▷ Press the **SET** button to save the setting.
- ▷ Press the **ESC (ON/OFF)** button to leave the menu item without saving the setting.

i “Operating elements of the SKP 100 G4 plug-on transmitter”

>> “Displays on the SKP 100 G4 plug-on transmitter display panel”

>> “Setting options in the menu”



Setting options in the menu

In the SKP 100 G4 menu, you can configure the following settings.

Adjusting the input sensitivity

- ▷ See “Sensitivity menu item”

Setting the frequency bank and the channel

- ▷ See “Frequency Preset menu item”

Entering a freely selectable name

- ▷ See “Name menu item”

Activating/deactivating the automatic lock-off function

- ▷ See “Auto Lock menu item”

Configuring enhanced settings in the **Advanced Menu**:

- Adjusting the transmission frequencies for the U frequency bank
 - Configuring the MUTE switch
 - Configuring the guitar cable emulation
 - Activating/deactivating the pilot tone evaluation
 - Adjusting the contrast of the display panel
 - Resetting the transmitter
 - Displaying the current software revision
 - ▷ See “Advanced menu item”
-



Sensitivity menu item

- Adjusting the input sensitivity – **AF** audio level

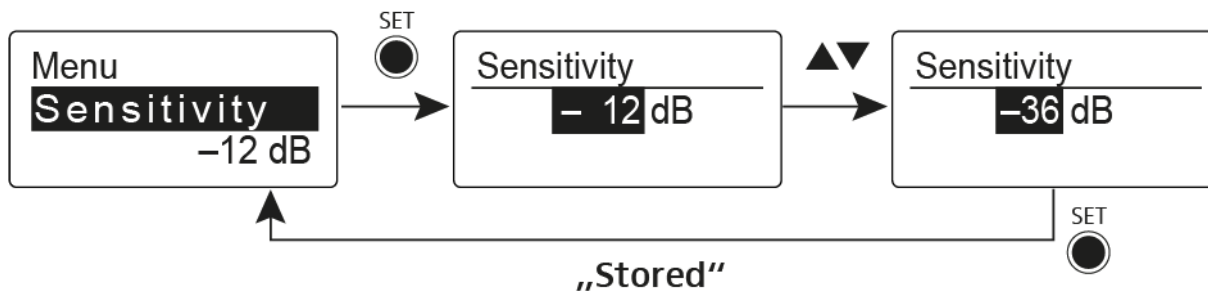

Setting range: 0 dB to -48 dB in 6 dB steps.

The **AF** audio level is also displayed when the plug-on transmitter is muted, e.g. to check the sensitivity before a live broadcast.

Frequency Preset menu item

- Manually selecting a frequency bank and channel

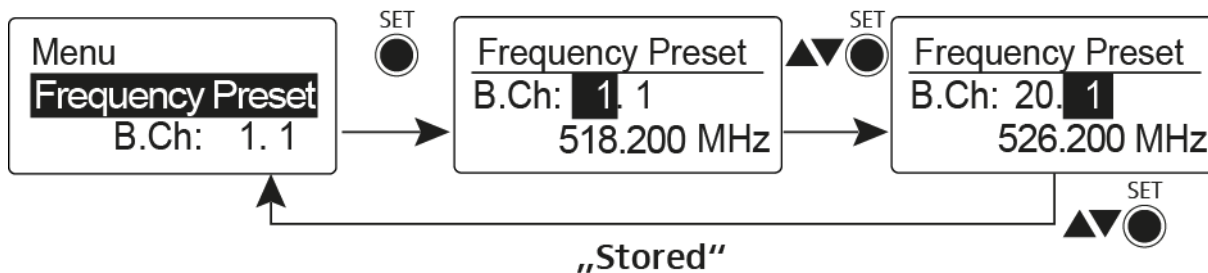

i While you work in the Frequency Preset menu, the RF signal is deactivated.

Please note when creating multi-channel systems:

Only the factory-preset frequencies within one frequency bank are intermodulation-free. The bodypack transmitter and receiver must be set to the same frequency. Be sure to note the information on frequency selection under “Establishing a radio link”.



Name menu item

- Entering names

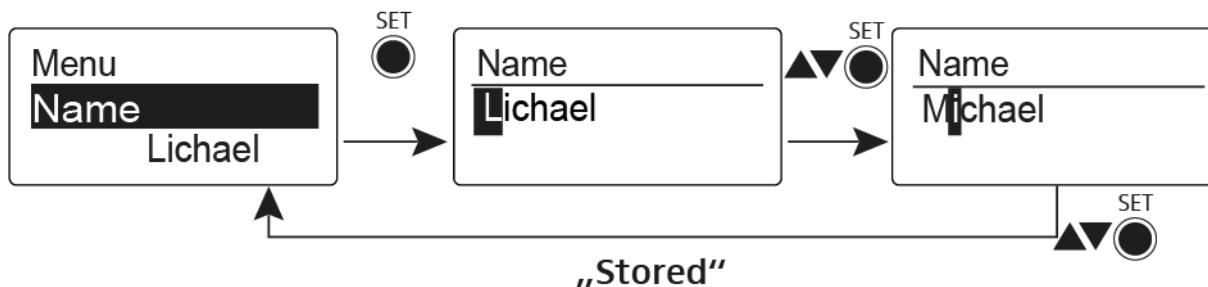

In the **Name** menu item you can enter any name you want for the bodypack transmitters (e.g. the names of the musicians).

The name can be shown in the [Frequency/Name](#) and [Name/Channel](#) standard displays.

The names are a maximum of 8 characters:

- All letters except umlauts.
- Numbers from 0 to 9
- Special characters and spaces

Enter the names as follows:

- ▷ Press the **UP** or **DOWN** buttons to select a character.
- ▷ Press the **SET** button to switch to the next space or to save the name you have entered once it is complete.

Auto Lock menu item

- Switching the automatic lock-off function on and off

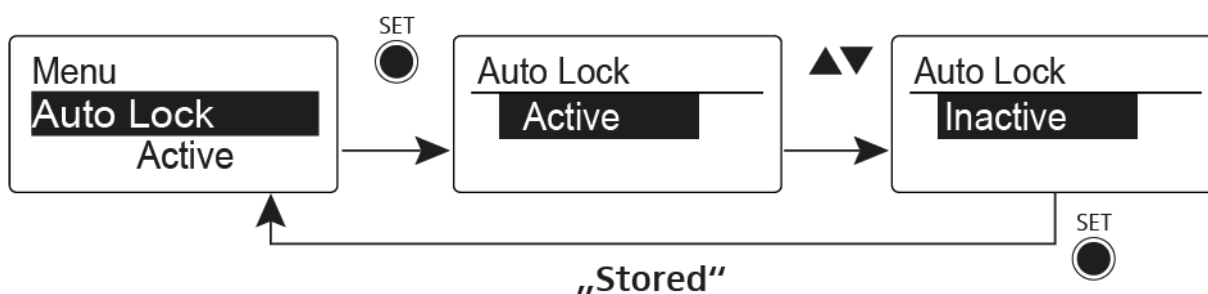

This lock prevents the wireless microphone from being unintentionally switched off and also prevents any unintentional changes to the transmitter's configuration. In the current standard display, the lock icon shows whether the lock-off function is currently switched on.

You can find information about using the lock-off function under "Lock-off function".



Advanced menu item

In the **Advanced** submenu you can configure enhanced settings.

The following sub-items are available:

Adjusting the transmission frequencies for the U frequency bank

- ▷ See “Advanced > Tune menu item”

Configuring the MUTE switch

- ▷ See “Advanced > Mute Mode menu item”

Activating/deactivating the pilot tone evaluation

- ▷ See “Advanced > Pilot Tone menu item”

Adjusting the contrast of the display panel

- ▷ See “Advanced > LCD Contrast menu item”

Resetting the transmitter

- ▷ See “Advanced > Reset menu item”

Displaying the current software revision

- ▷ See “Advanced > Software Revision menu item”
-



Advanced > Tune menu item

- Configuring the transmission frequency and frequency bank U

When you have configured the bodypack transmitter to a system bank and you call up the **Tune** menu item, channel 1 of the frequency bank **U** is automatically set. The message **U.1** briefly appears in the display. In the factory settings, the channels of the frequency bank **U** are not assigned to any transmission frequency.

While you work in the **Tune** menu, the RF signal is deactivated.

You can configure a transmission frequency for the current channel or select a channel in the frequency bank **U** and configure a transmission frequency for this channel in the **Tune** menu. Be sure to note the information on frequency selection, see “Setting notes”.

Only adjusting the frequency

To configure the transmission frequency for the current channel:

- ▷ Open the **Tune** menu item in the **Advanced** menu.
The frequency selection appears.

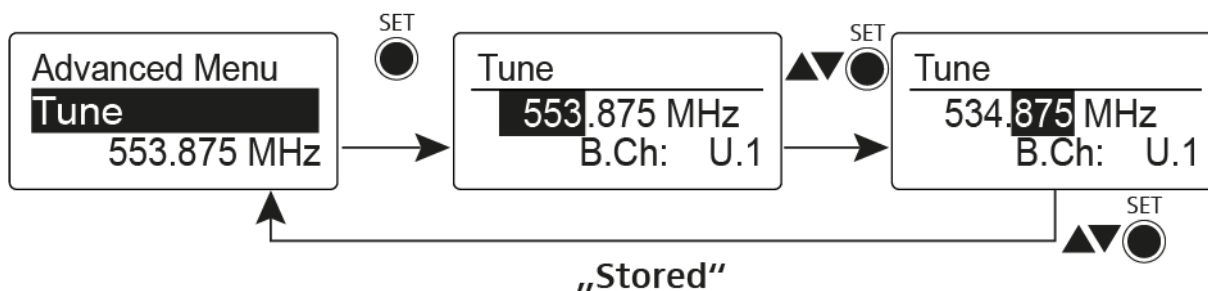

- ▷ Configure the desired frequency.
- ▷ Press the **SET** button.
Your settings will be saved. You are now back in the operating menu.

Setting the channel and frequency

To select a **channel** and assign it a frequency:

- ▷ Open the **Tune** menu item in the **Advanced** menu by pressing and holding the **SET** button until the frequency bank selection appears.

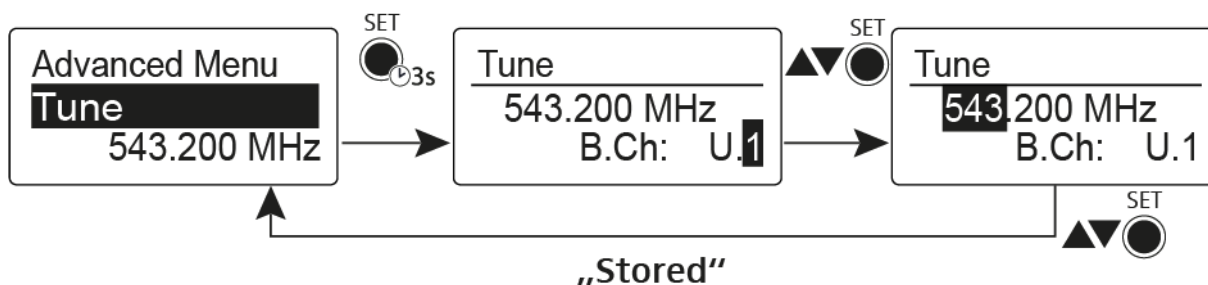

- ▷ Set the desired channel.
- ▷ Press the **SET** button.
The frequency selection appears.
- ▷ Configure the frequency.



Advanced > Mute Mode menu item

- Configuring the **MUTE** switch

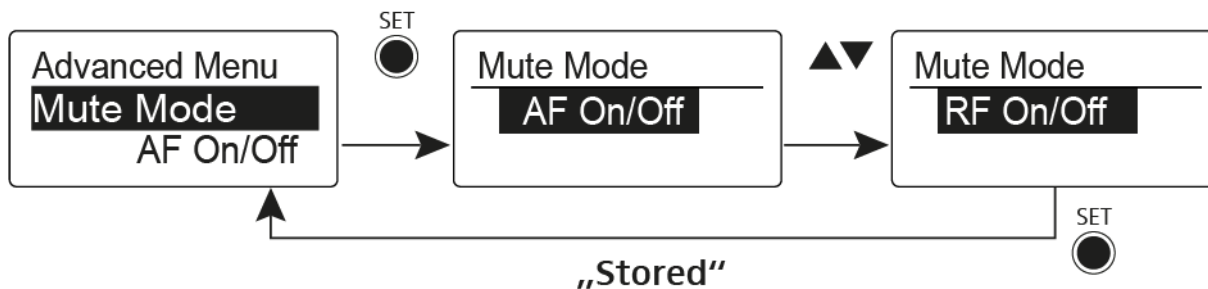

AF On/Off mode

- If set to position MUTE, the audio signal is muted.

RF On/Off mode

- If set to position MUTE, the RF signal is deactivated.

Disabled mode

- No function

You can find information about operating the mute switch under “Muting the plug-on transmitter (AF mute)” and “Deactivating the RF signal (RF mute)”.

Advanced > Pilot Tone menu item

- Activating/deactivating pilot tone transmission

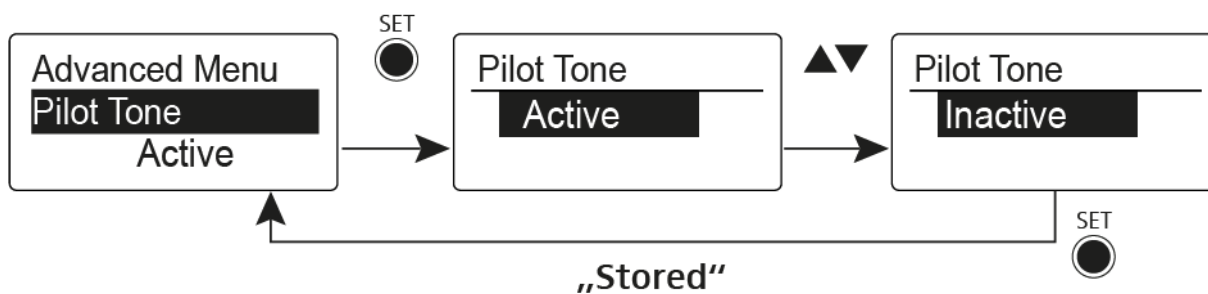

The pilot tone has an inaudible frequency that is sent from the transmitter and evaluated by the receiver. It supports the receiver’s squelch function.

Advanced > LCD Contrast menu item

- Adjusting the contrast of the display panel

You can configure the contrast of the display in 16 steps.



Advanced > Reset menu item

- Resetting the plug-on transmitter

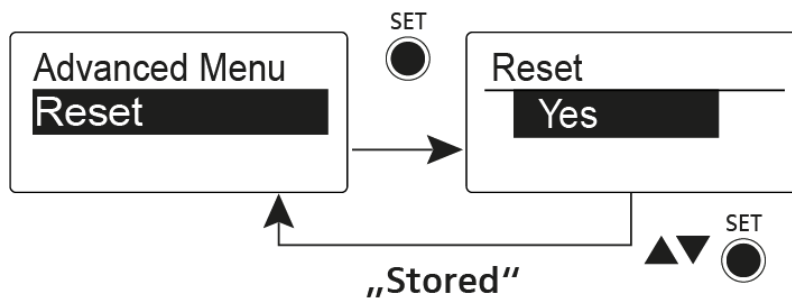

When you reset the plug-on transmitter, only the selected settings of the pilot tone and the **U** frequency bank are retained.

Advanced > Software Revision menu item

- Show software revision

You can display the current software revision.



Establishing a radio link

To establish a radio link between the transmitter and receiver, the same frequency must be set in both devices.

You can do this in a number of different ways:

1. Use the **Easy Setup** function to perform an **automatic frequency set-up** (see “Easy Setup menu item”).
2. Set a frequency in the receiver **manually** (see “Frequency Preset menu item”) and **synchronize** it with the transmitter (see “Synchronizing devices”).
3. Set the frequency on the receiver and the transmitter **manually** (EK 100 G4: “Frequency Preset menu item”, SKM 100 G4: “Frequency Preset menu item”, SK 100 G4: “Frequency Preset menu item”, SKP 100 G4: “Frequency Preset menu item”)

Setting notes

Please note the following when synchronizing a transmitter with a receiver:

- ▷ Only use transmitters and receivers from the same frequency range (see the type plate on the transmitter and receiver).
- ▷ Make sure that your chosen frequencies are listed in the frequency table for the particular frequency range (see “Frequency tables”).
- ▷ Ensure that the desired frequencies are permitted in your country and apply for an operating license if necessary.



Please note the information at the following address:

General conditions and restrictions for the use of frequencies



Synchronizing devices

You can synchronize ew 100 P G4 series transmitters and receivers via the receiver's infrared interface.

To synchronize the devices:

- ▷ Switch the transmitter and the receiver on.
- ▷ Call up the **Sync** menu item on the receiver.
Sync appears in the receiver's display.
- ▷ Hold the infra-red interface of the transmitter in front of the infra-red interface of the receiver.

The parameters are transferred to the transmitter. When the transfer is complete, a tick appears in the receiver's display as a confirmation. Then the receiver will return to the current standard display.



To cancel synchronization:

- ▷ Press the **ON/OFF** button on the receiver.
An **X** appears in the display.

This icon also appears when:

- no transmitter is found or the transmitter is not compatible.
- no transmitter is found and the synchronization process automatically ends after 30 seconds.



SPECIFICATIONS

Overview

In the sections below, you can find information about the different variants of the products in the **ew 100 P G4** series as well as technical data for the individual products.

- Product variants and frequency variants >> “Product variants”
- Frequency tables with overviews of all banks and channels >> “Frequency tables”
- Product-specific technical data >> “Specifications”
- Information on pin assignment (jack and XLR) >> “Pin assignment”

You can also find information about safely cleaning and maintaining **evolution wireless G4** series products as well as help in the event of malfunctions.

- “Cleaning and maintenance”



Product variants

EK 100 G4 product variants

Made in Germany

EK 100 G4-A1	470 – 516 MHz	Art. no. 507644
EK 100 G4-A	516 – 558 MHz	Art. no. 507645
EK 100 G4-GB	606 – 648 MHz	Art. no. 507646
EK 100 G4-G	566 – 608 MHz	Art. no. 507647
EK 100 G4-B	626 – 668 MHz	Art. no. 507648
EK 100 G4-C	734 – 776 MHz	Art. no. 507649
EK 100 G4-E	823 – 865 MHz	Art. no. 507650
EK 100 G4-K+	925 – 937.5 MHz	Art. no. 507651

Assembled in the USA

EK 100 G4-A1	470 – 516 MHz	Art. no. 507985
EK 100 G4-A	516 – 558 MHz	Art. no. 507986
EK 100 G4-AS	520 – 558 MHz	Art. no. 507987
EK 100 G4-G	566 – 608 MHz	Art. no. 507988
EK 100 G4-B	626 – 668 MHz	Art. no. 507989
EK 100 G4-C	734 – 776 MHz	Art. no. 507990
EK 100 G4-D	780 – 822 MHz	Art. no. 507991
EK 100 G4-JB	806 – 810 MHz	Art. no. 507992



SKM 100 G4 product variants

Made in Germany

SKM 100 G4-S-A1	470 – 516 MHz	Art. no. 507594
SKM 100 G4-S-A	516 – 558 MHz	Art. no. 507595
SKM 100 G4-S-GB	606 – 648 MHz	Art. no. 507596
SKM 100 G4-S-G	566 – 608 MHz	Art. no. 507597
SKM 100 G4-S-B	626 – 668 MHz	Art. no. 507598
SKM 100 G4-S-C	734 – 776 MHz	Art. no. 507599
SKM 100 G4-S-E	823 – 865 MHz	Art. no. 507600
SKM 100 G4-S-1G8	1785 – 1800 MHz	Art. no. 507601
SKM 100 G4-S-K+	925 – 937.5 MHz	Art. no. 507602

SKM 100 G4-A1	470 – 516 MHz	Art. no. 507660
SKM 100 G4-A	516 – 558 MHz	Art. no. 507661
SKM 100 G4-GB	606 – 648 MHz	Art. no. 507662
SKM 100 G4-G	566 – 608 MHz	Art. no. 507663
SKM 100 G4-B	626 – 668 MHz	Art. no. 507664
SKM 100 G4-C	734 – 776 MHz	Art. no. 507665
SKM 100 G4-E	823 – 865 MHz	Art. no. 507666
SKM 100 G4-1G8	1785 – 1800 MHz	Art. no. 507667
SKM 100 G4-K+	925 – 937.5 MHz	Art. no. 507668

Assembled in the USA

SKM 100 G4-S-A1	470 – 516 MHz	Art. no. 507937
SKM 100 G4-S-A	516 – 558 MHz	Art. no. 507938
SKM 100 G4-S-AS	520 – 558 MHz	Art. no. 507939
SKM 100 G4-S-G	566 – 608 MHz	Art. no. 507940
SKM 100 G4-S-B	626 – 668 MHz	Art. no. 507941
SKM 100 G4-S-C	734 – 776 MHz	Art. no. 507942
SKM 100 G4-S-D	780 – 822 MHz	Art. no. 507943
SKM 100 G4-S-JB	806 – 810 MHz	Art. no. 507945



SKM 100 G4-A1	470 – 516 MHz	Art. no. 508001
SKM 100 G4-A	516 – 558 MHz	Art. no. 508002
SKM 100 G4-AS	520 – 558 MHz	Art. no. 508003
SKM 100 G4-G	566 – 608 MHz	Art. no. 508004
SKM 100 G4-B	626 – 668 MHz	Art. no. 508005
SKM 100 G4-C	734 – 776 MHz	Art. no. 508006
SKM 100 G4-D	780 – 822 MHz	Art. no. 508007
SKM 100 G4-JB	806 – 810 MHz	Art. no. 508008

SK 100 G4 product variants

Made in Germany

SK 100 G4-A1	470 – 516 MHz	Art. no. 507585
SK 100 G4-A	516 – 558 MHz	Art. no. 507586
SK 100 G4-GB	606 – 648 MHz	Art. no. 507587
SK 100 G4-G	566 – 608 MHz	Art. no. 507588
SK 100 G4-B	626 – 668 MHz	Art. no. 507589
SK 100 G4-C	734 – 776 MHz	Art. no. 507590
SK 100 G4-E	823 – 865 MHz	Art. no. 507591
SK 100 G4-1G8	1785 – 1800 MHz	Art. no. 507592
SK 100 G4-K+	925 – 937.5 MHz	Art. no. 507593

Assembled in the USA

SK 100 G4-A1	470 – 516 MHz	Art. no. 507929
SK 100 G4-A	516 – 558 MHz	Art. no. 507930
SK 100 G4-AS	520 – 558 MHz	Art. no. 507931
SK 100 G4-G	566 – 608 MHz	Art. no. 507932
SK 100 G4-B	626 – 668 MHz	Art. no. 507933
SK 100 G4-C	734 – 776 MHz	Art. no. 507934
SK 100 G4-D	780 – 822 MHz	Art. no. 507935
SK 100 G4-JB	806 – 810 MHz	Art. no. 507936



SKP 100 G4 product variants

Made in Germany

SKP 100 G4-A1	470 – 516 MHz	Art. no. 507652
SKP 100 G4-A	516 – 558 MHz	Art. no. 507653
SKP 100 G4-GB	606 – 648 MHz	Art. no. 507654
SKP 100 G4-G	566 – 608 MHz	Art. no. 507655
SKP 100 G4-B	626 – 668 MHz	Art. no. 507656
SKP 100 G4-C	734 – 776 MHz	Art. no. 507657
SKP 100 G4-E	823 – 865 MHz	Art. no. 507658
SKP 100 G4-K+	925 – 937.5 MHz	Art. no. 507659

Assembled in the USA

SKP 100 G4-A1	470 – 516 MHz	Art. no. 507993
SKP 100 G4-A	516 – 558 MHz	Art. no. 507994
SKP 100 G4-AS	520 – 558 MHz	Art. no. 507995
SKP 100 G4-G	566 – 608 MHz	Art. no. 507996
SKP 100 G4-B	626 – 668 MHz	Art. no. 507997
SKP 100 G4-C	734 – 776 MHz	Art. no. 507998
SKP 100 G4-D	780 – 822 MHz	Art. no. 507999
SKP 100 G4-JB	806 – 810 MHz	Art. no. 508000



Frequency tables

You can find frequency tables for all available frequency ranges in the download section of the Sennheiser website under www.sennheiser.com/download.

Download area of the Sennheiser website

Enter **ew G4** into the search bar to show the frequency tables.



Specifications

You can find the cross-system and product-specific technical data in the sections below.



EK 100 G4

RF characteristics

Modulation	Wideband FM
Receiving frequency ranges	A1: 470 – 516 MHz A: 516 – 558 MHz AS: 520 – 558 MHz G: 566 – 608 MHz GB: 606 – 648 MHz B: 626 – 668 MHz C: 734 – 776 MHz D: 780 – 822 MHz TH: 794 – 806 MHz E: 823 – 865 MHz JB: 806 – 810 MHz K+: 925 – 937.5 MHz
Receiving frequencies	Max 1680 receiving frequencies, adjustable in 25 kHz steps 20 frequency banks, each with up to 12 factory-preset channels, no intermodulation 1 frequency bank with up to 12 programmable channels
Switching bandwidth	up to 42 MHz
Nominal/peak deviation	± 24 kHz / ± 48 kHz
Receiver principle	Adaptive diversity
Sensitivity (with HDX, peak deviation)	$< 1.6 \mu\text{V}$ for 52 dBA _{eff S/N}
Adjacent channel selection	≥ 65 dB
Intermodulation attenuation	≥ 65 dB
Blocking	≥ 70 dB
Squelch	Low: 5 dB μV Middle: 15 dB μV High: 25 dB μV
Pilot tone squelch	Can be switched off



AF characteristics

Compander system	Sennheiser HDX
Signal-to-noise ratio (1 mV, peak deviation)	≥ 110 dBA
Total harmonic distortion (THD)	≤ 0.9 %
AF output voltage (at peak deviation, 1 kHz AF)	3.5 mm jack socket +12 dBu (mono, unbalanced)
“AF Out” setting range	48 dB (in 6 dB steps)

Overall device

Temperature range	-10 °C to +55 °C (14 °F to 131 °F)
Power supply	2 AA batteries, 1,5 V or BA 2015 accupack
Nominal voltage	3 V battery / 2.4 V rechargeable battery
Power consumption	at nominal voltage: typically 180 mA with transmitter switched off: ≤ 25 µA
Operating time	Typically 8 h
Dimensions	Approx. 82 x 64 x 24 mm
Weight (with batteries)	Approx. 160 g



SKM 100 G4

RF characteristics

Modulation	Wideband FM
Receiving frequency ranges	A1: 470 – 516 MHz A: 516 – 558 MHz AS: 520 – 558 MHz G: 566 – 608 MHz GB: 606 – 648 MHz B: 626 – 668 MHz C: 734 – 776 MHz D: 780 – 822 MHz E: 823 – 865 MHz JB: 806 – 810 MHz K+: 925 – 937.5 MHz 1G8: 1785 – 1800 MHz
Transmission frequencies	Max 1680 receiving frequencies, adjustable in 25 kHz steps 20 frequency banks, each with up to 12 factory-preset channels 1 frequency bank with up to 12 programmable channels
Switching bandwidth	up to 42 MHz
Nominal/peak deviation	± 24 kHz / ± 48 kHz
Frequency stability	$\leq \pm 15$ ppm
RF output power at 50 ?	Max. 30 mW
Pilot tone squelch	Can be switched off

AF characteristics

Compander system	Sennheiser HDX
AF frequency response	80 – 18,000 Hz
Signal-to-noise ratio (1 mV, peak deviation)	≥ 110 dBA
Total harmonic distortion (THD)	≤ 0.9 %
Input voltage	$3 V_{\text{eff}}$
Input impedance	40 k Ω
Input capacitance	Switchable
Setting range for input sensitivity	48 dB in 6 dB steps



Overall device

Temperature range	-10 °C to +55 °C (14 °F to 131 °F)
Power supply	2 AA batteries, 1,5 V or BA 2015 accupack
Nominal voltage	3 V battery / 2.4 V rechargeable battery
Power consumption	
at nominal voltage with transmitter switched off	typically 180 mA ≤ 25 µA
Operating time	Typically 8 h
Dimensions	Approx. Ø 50 x 265 mm
Weight (with batteries)	Approx. 450 g



SK 100 G4

RF characteristics

Modulation	Wideband FM
Receiving frequency ranges	A1: 470 – 516 MHz A: 516 – 558 MHz AS: 520 – 558 MHz G: 566 – 608 MHz GB: 606 – 648 MHz B: 626 – 668 MHz C: 734 – 776 MHz D: 780 – 822 MHz E: 823 – 865 MHz JB: 806 – 810 MHz K+: 925 – 937.5 MHz 1G8: 1785 – 1800 MHz
Transmission frequencies	Max. 1680 receiving frequencies, adjustable in 25 kHz steps 20 frequency banks, each with up to 12 factory-preset channels 1 frequency bank with up to 12 programmable channels
Switching bandwidth	up to 42 MHz
Nominal/peak deviation	±24 kHz / ±48 kHz
Frequency stability	≤ ±15 ppm
RF output power at 50 ?	Max. 30 mW
Pilot tone squelch	Can be switched off

AF characteristics

Compander system	Sennheiser HDX
AF frequency response	Microphone: 80 – 18,000 Hz Line: 25 – 18,000 Hz
Signal-to-noise ratio (1 mV, peak deviation)	≥ 110 dBA
Total harmonic distortion (THD)	≤ 0.9 %
Max. input voltage Microphone/line	3 V _{eff}
Input impedance Microphone/line	40 kΩ, unbalanced/1 MΩ
Input capacitance	Switchable
Setting range for input sensitivity	60 dB in 3 dB steps



Overall device

Temperature range	-10 °C to +55 °C (14 °F to 131 °F)
Power supply	2 AA batteries, 1,5 V or BA 2015 accupack
Nominal voltage	3 V battery 2.4 V rechargeable battery
Power consumption	
at nominal voltage with transmitter switched off	typically 180 mA ≤ 25 µA
Operating time	Typically 8 h
Dimensions	approx. 82 x 64 x 24 mm
Weight (with batteries)	Approx. 160 g



SKP 100 G4

RF characteristics

Modulation	Wideband FM
Receiving frequency ranges	A1: 470 – 516 MHz A: 516 – 558 MHz AS: 520 – 558 MHz G: 566 – 608 MHz GB: 606 – 648 MHz B: 626 – 668 MHz C: 734 – 776 MHz D: 780 – 822 MHz E: 823 – 865 MHz JB: 806 – 810 MHz K+: 925 – 937.5 MHz
Transmission frequencies	Max 1680 receiving frequencies, adjustable in 25 kHz steps 20 frequency banks, each with up to 12 factory-preset channels 1 frequency bank with up to 12 programmable channels
Switching bandwidth	up to 42 MHz
Nominal/peak deviation	± 24 kHz / ± 48 kHz
Frequency stability	$\leq \pm 15$ ppm
RF output power at 50 ?	Max. 30 mW
Pilot tone squelch	Can be switched off



AF characteristics

Compander system	Sennheiser HDX
AF frequency response	80 – 18,000 Hz
Signal-to-noise ratio (1 mV, peak deviation)	≥ 110 dBA
Total harmonic distortion (THD)	≤ 0.9 %
Input voltage	3.3 V _{eff}
Input impedance	68 kΩ, unbalanced
Input capacitance	Switchable
Setting range for input sensitivity	48 dB in 6 dB steps

Overall device

Temperature range	-10 °C to +55 °C (14 °F to 131 °F)
Power supply	2 AA batteries, 1,5 V or BA 2015 accupack
Nominal voltage	3 V battery / 2.4 V rechargeable battery
Power consumption	at nominal voltage: typically 180 mA with transmitter switched off: ≤ 25 μA
Operating time	Typically 8 h
Dimensions	Approx. 105 x 43 x 43 mm
Weight (with batteries)	Approx. 195 g



Pin assignment

3.5 mm stereo jack plug

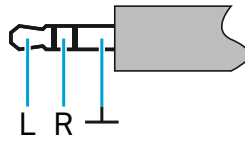

- Plug for headphone and earphone cables, e.g. IE 4.
- Connect to:
 - EK IEM G4
 - EK 500 G4

3.5 mm mic jack plug

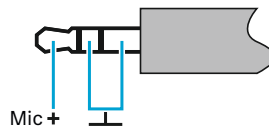

- Plug for lavalier and headset microphone, e.g. ME 2.
- Connect to:
 - SK 100 G4
 - SK 300 G4
 - SK 500 G4

3.5 mm line jack plug

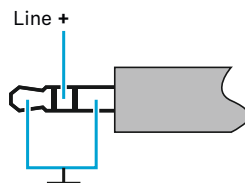

- Plug for line and instrument cables, e.g. Ci 1-N
- Connect to:
 - SK 100 G4
 - SK 300 G4
 - SK 500 G4

6.3 mm stereo jack plug, balanced (audio in/loop out)

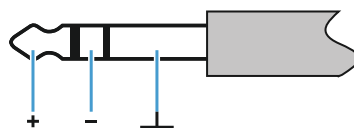

- Connect to:
 - SR IEM G4 Audio In
 - SR IEM G4 Loop Out



6.3 mm mono jack plug, unbalanced

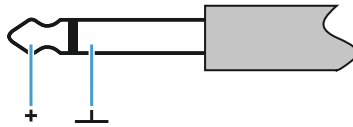

- Connect to:
 - EM 100 G4 Audio Out
 - EM 300-500 G4 Audio Out

6.3 mm stereo jack plug for headphone jack

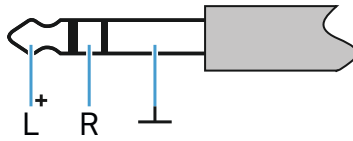

- Connect to:
 - EM 100 G4 headphone input
 - EM 300-500 G4 headphone input
 - SR IEM G4 headphone input

XLR-3 plug, balanced

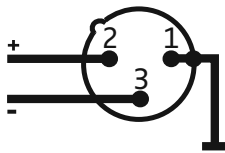

Hollow jack plug for power supply





Cleaning and maintenance

Note the following information when cleaning and maintaining evolution wireless G4 series products.

CAUTION

Liquids can damage the products' electronics.

Liquids entering the product housing can cause a short-circuit and damage the electronics.

- ▷ Keep all liquids away from the products.
 - ▷ Do not use any solvents or cleansing agents.
-
- ▷ Disconnect the products from the power supply system and remove rechargeable batteries and batteries before you begin cleaning.
 - ▷ Clean all products only with a soft, dry cloth.
 - ▷ Note the special cleaning instructions below for the following products.

Cleaning the sound inlet basket of the microphone module

- ▷ Unscrew the top sound inlet basket from the microphone module by turning it counterclockwise.
- ▷ Remove the foam insert.

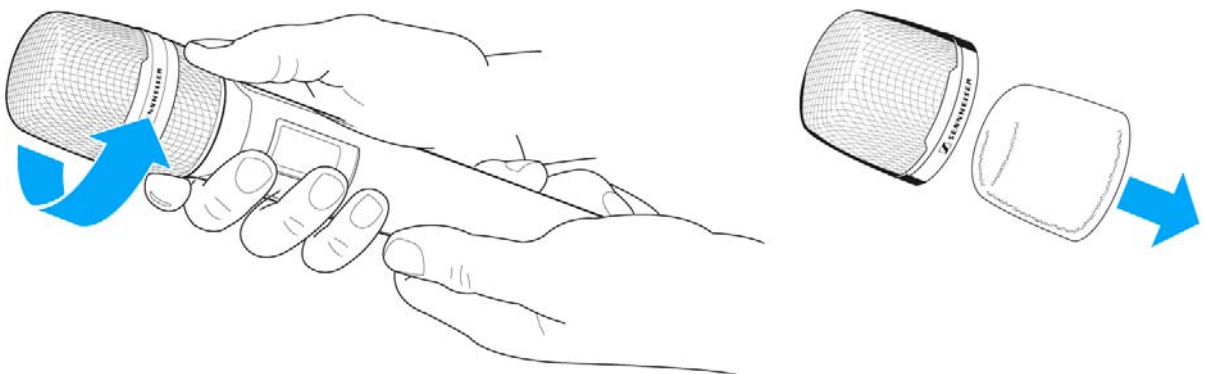

You can clean the sound inlet basket in two ways:

- ▷ Use a slightly damp cloth to clean the top sound inlet basket from the inside and outside.
- ▷ Use a brush and rinse with clean water.
- ▷ If necessary, clean the foam insert with a mild detergent or replace the foam insert.
- ▷ Dry the top sound inlet basket and foam insert.
- ▷ Reinsert the foam insert.



- ▷ Screw the sound inlet basket back onto the microphone module.

From time to time, you should also clean the microphone module contacts:

- ▷ Wipe the contacts of the microphone module with a soft, dry cloth.