

Solid-State Memory Camcorder

Operating Guide

Table of Contents

Getting Started

Recording

Playback

Editing

Using the Menu

Troubleshooting

Additional Information

XDCAM

XAVC

AVCHD
Progressive

Exmor™
CMOS Sensor

MEMORY STICK™



HDMI®
HIGH DEFINITION MULTIMEDIA INTERFACE



Read this first

Before operating this unit, please read this manual thoroughly, and retain it for future reference.

Precautions when using the camcorder

- Do not hold the camcorder by the following parts, and also do not hold the camcorder by the jack covers.

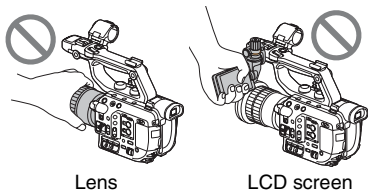

Lens

LCD screen

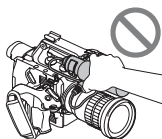

Microphone (sold separately) or
Microphone holder

Notes

- The camcorder is not dustproof, dripproof or waterproof. See “About handling of your camcorder” (p. 188).
- When connecting the camcorder to another device with communication cables, be sure to insert the connector plug in the correct way. Pushing the plug forcibly into the terminal will damage the terminal and may result in a malfunction of the camcorder.
- Use your camcorder in accordance with country/region regulations.

On the LCD screen

- A menu item that is grayed out is not available under the current recording or playback conditions.
- The LCD screen is manufactured using extremely high-precision technology, so over 99.99% of the pixels are operational for effective use. However, there may be some tiny black points and/or bright points (white, red, blue, or green in color) that appear constantly on the LCD screen. These points are normal results of the manufacturing process and do not affect the recording in any way.

White, red, blue or
green point
Black point

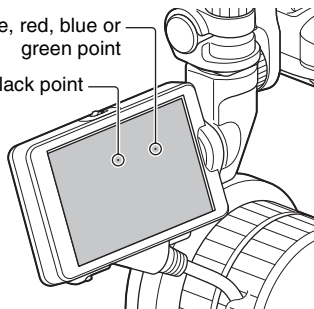

On sunlight

- Do not record the sun or leave the camcorder under the sun. The internal parts of the camcorder may be damaged. If sunlight is focused on a nearby object, it may cause a fire. When you must place the camcorder under direct sunlight, attach the front lens cap.
- Do not expose your camcorder's viewfinder, lens, or LCD screen to the sun or strong light source for extended periods. Doing so may cause a malfunction of the camcorder.
- Do not attempt to record the sun directly. Doing so may cause a malfunction of the camcorder.
- Do not look at the sun or a strong light through a removed lens. This may cause irrecoverable damage to your eyes. Also, this may cause a malfunction.
- Do not expose the lens to beams, such as laser beams.
That may damage the image sensor and cause the camera to malfunction.

On the temperature of your camcorder and battery pack

- Your camcorder has a protective function that disables recording or playback if the temperature of your camcorder or battery pack is beyond the safely operable range. In this case, a message appears on the LCD screen (p. 176).

On recording

- When the memory card access lamp is lit or flashing in red, your camcorder is reading or writing data. Do not apply any vibrations or shocks to your camcorder. Do not turn the power off, and do not remove the memory cards, battery pack, or the AC Adapter. The image data may be destroyed.
- In order to stabilize memory card operation, it is recommended that you format the memory card when you use it with your camcorder for the first time. All data recorded on the memory card will be erased by formatting, and cannot be recovered. Save important data on the memory card on other media, such as a computer, before formatting the memory card.
- Before starting to record, test the recording function to make sure the picture and sound are recorded without any problems.
- Compensation for the loss of the content of recordings or the loss of recording opportunities cannot be provided, even if recording or playback is not possible due to a malfunction of the camcorder, storage media, etc., or even if images or sounds are distorted due to the limits of the capabilities of the camcorder.
- TV color systems differ depending on the countries/regions. To view your recordings on a TV, you need to set [60i/50i SEL] in accordance with the country/region.
- Television programs, films, video tapes, and other materials may be copyrighted. Unauthorized recording of such materials may be contrary to the copyright laws.
- Because of the way that the image device (CMOS sensor) reads out image signals, the following phenomena may occur.
 - The subjects passing by the frame rapidly might appear crooked depending on the recording conditions. (This phenomenon may be notable in displays having high motion resolution.)

- Horizontal lines appear on the LCD screen during recording under fluorescent lights, sodium lamps or mercury lamps. The phenomena can be reduced by adjusting the shutter speed (p. 51).
- Images on the LCD screen look horizontally divided when a subject is continuously lit with a flash. The effect of this phenomenon may be reduced by using a slower shutter speed. Also, you may try using software to repair the image.

Save all your recorded image data

- To prevent your image data from being lost, save all your recorded images on external media periodically.

To handle the recorded images on your computer

- Download the “Catalyst Browse” software.

Format the memory card using [MEDIA FORMAT] if images are not recorded or played back properly

- If you continue recording and deleting images on memory cards for a long time, the files on that memory card may become fragmented. As a result, you may not be able to record and save images properly. If this happens, save the images on a separate recordable media, such as a disc or computer, then format the memory card. See “Formatting a memory card” (p. 136).

Read this first (continued)

About the operation of the camcorder

- The operation of the camcorder is controlled using the SEL/SET dial (p. 7, 139) or the multi-selector on the grip (p. 10).

About this manual

- Operations in this manual are described using the “SELP18105G” lens. When the operation differs depending on the lens used, you will find the relevant information in “Notes” or “Tips.”
- The values you can set in [REC FORMAT] and other menus depend on the [60i/50i SEL] setting. In this manual, the values for both [60i] and [50i] settings are described.
- The images of the LCD screen used in this manual for illustration purposes are captured using a digital still camera.
- The on-screen displays in each local language are used for illustrating the operating procedures. Change the screen language before using your camcorder if necessary (p. 165).
- Design and specifications of memory cards and other accessories are subject to change without notice.

About upgrade licenses and firmware versions

Some of the functions described in this manual require an upgrade license (option) and firmware of a specified version or later.

Purchase option products and upgrade the camera firmware according to the devices used.

Function	See page	PXW-FS5		PXW-FS5M2/FS5M2K	
		Firmware version	Upgrade license	Firmware version	Upgrade license
External output and face detection support when recording in XAVC QFHD (4K mode)	133	Ver. 1.1 or later	–	Ver. 1.0 or later	–
Auto ND Filter	54	Ver. 2.0 or later	–		–
Recording in RAW format using a RAW recorder (sold separately)	70		Purchase of CBKZ-FS5RIF required.		Purchase not required (pre-installed)
Zebra 1 / Zebra 2	54		–		–
Setting the headphone output	84		–		–
GPS function	115		–		–
MPEG HD recording	73	Ver. 3.0 or later	Purchase of CBKZ-SLMP required.	Purchase of CBKZ-SLMP required.	
High dynamic range (HDR)	57	Ver. 4.0 or later	–	–	
Expansion of ISO/GAIN settings	147		–	–	
High frame rate (HFR)	68		Purchase of CBKZ-FS5HFR required.	Purchase not required (pre-installed)	

Identifying parts and controls

Body

The numbers in () are reference pages.

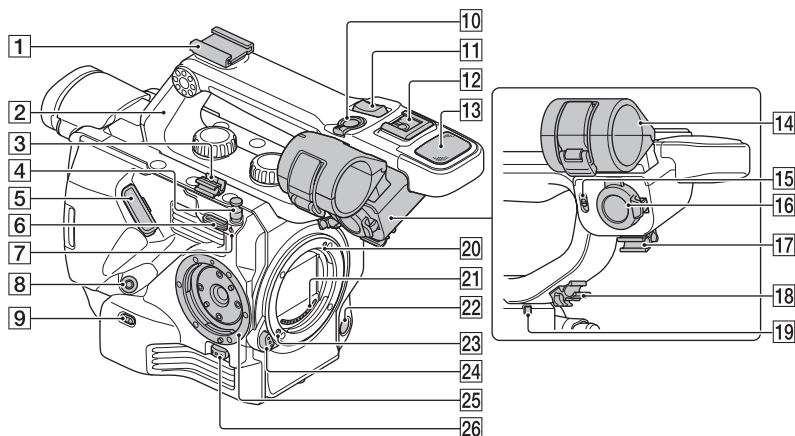

- 1** Accessory shoe (with cold shoe attached)
For details about attachment, see page 27.
 - 2** XLR handle (attached)
For details about attachment, see page 26.
 - 3** Cable clamper
 - 4** Tape measure hook (p. 45)
 - 5** LCD screen connection jack (p. 29)
 - 6** Shoulder strap attachment point
 - 7** Image sensor position index (p. 45)
 - 8** REMOTE jack (p. 31)
 - 9** INPUT 1 (LINE/MIC/MIC+48V) switch (p. 83)
 - 10** Handle record button (p. 40)
The handle record button is disabled when set to the HOLD position.
 - 11** Handle zoom lever (p. 43)
 - 12** Multi-interface shoe (p. 83)
 - 13** Internal microphone (p. 82)
 - 14** Microphone holder
 - 15** INPUT 2 (LINE/MIC/MIC+48V) switch (p. 83)
 - 16** INPUT 2 jack (p. 82)
 - 17** Cable clamper
 - 18** Cable clamper
 - 19** Recording lamp (front) (p. 40)
The recording lamp flashes if the remaining capacity of the memory card or battery is low.
 - 20** Mounting index point (p. 23)
 - 21** Lens contacts
- Note**
- Do not touch directly with your hands.
- 22** WB SET button (p. 56)
 - 23** Lens lock pin
 - 24** Lens release button (p. 23)
 - 25** Grip attachment point (p. 31)
 - 26** Grip release button (p. 32)

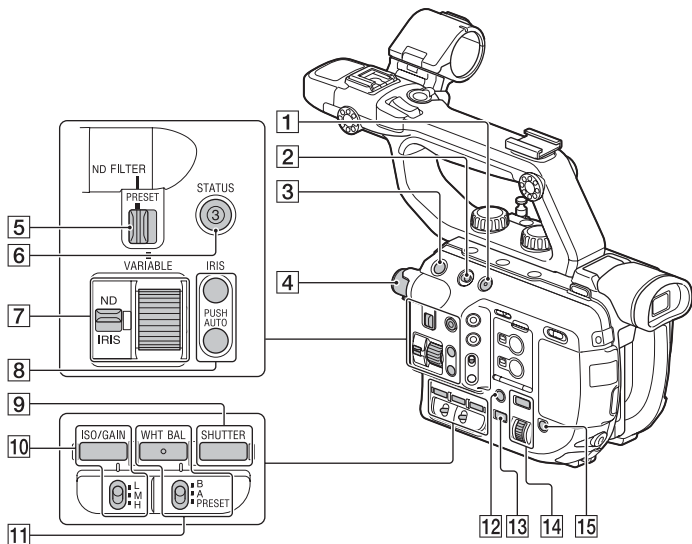

- | | |
|---------------------------------------------------------------------------------------------------------------------------------------------------------------------------------------------------------------------------------------------------------------------------------------------------------------------------------------------------------------------------------|----------------------------------------------------------------------------------------------------------------------------------------------------------------------------------------------------------------------------------------------------------------------------------------------------------------------------------------------|
| <p>1 FULL AUTO button (p. 102)</p> <p>2 HOLD switch (p. 113)</p> <p>3 START/STOP button (p. 40)</p> <p>4 ND FILTER dial (p. 53)</p> <p>5 PRESET/VARIABLE switch (p. 53)</p> <p>6 ASSIGN3/STATUS button (p. 123)</p> <p>7 ND/IRIS switch (p. 50, 53) — ND/IRIS dial (p. 53)</p> <p>8 IRIS — PUSH AUTO button (p. 50)</p> | <p>9 SHUTTER button (p. 51)</p> <p>10 ISO/GAIN button — L/M/H switch (p. 51)</p> <p>11 WHT BAL button — B/A/PRESET switch (p. 55)</p> <p>12 DISPLAY button (p. 122)</p> <p>13 THUMBNAIL button (p. 119)</p> <p>14 MENU button — SEL/SET dial (p. 139)</p> <p>15 SLOT SEL button (p. 39)</p> |
|---------------------------------------------------------------------------------------------------------------------------------------------------------------------------------------------------------------------------------------------------------------------------------------------------------------------------------------------------------------------------------|----------------------------------------------------------------------------------------------------------------------------------------------------------------------------------------------------------------------------------------------------------------------------------------------------------------------------------------------|

Identifying parts and controls (continued)

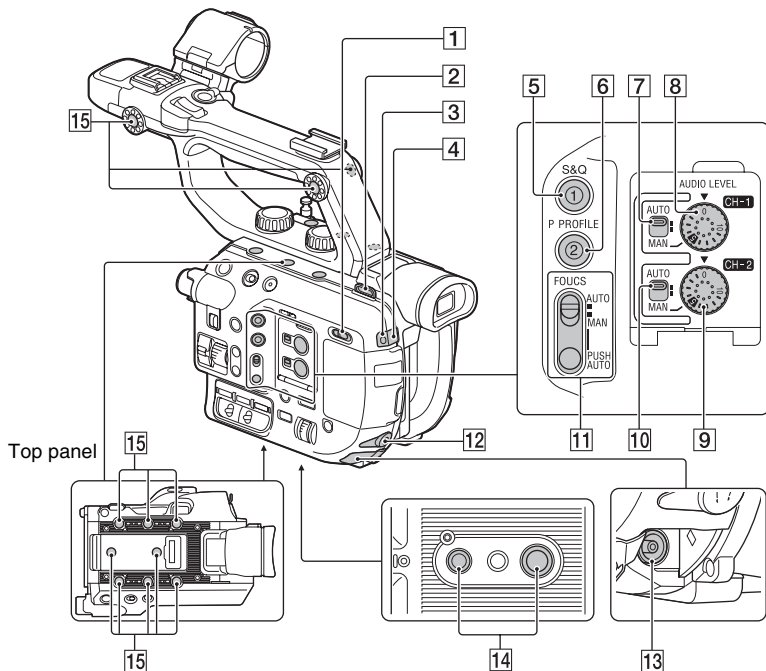

1 I/O (ON/STANDBY) switch (p. 33)

2 Shoulder strap attachment point

3 Recording lamp (rear) (p. 40)
The recording lamp flashes if the remaining capacity of the memory card or battery is low.

4 Remote control sensor

5 ASSIGN1/S&Q button (p. 63)

6 ASSIGN2/P PROFILE button (p. 103)

7 AUTO/MAN (CH-1) switch (p. 84)

8 AUDIO LEVEL (CH-1) dial (p. 84)

9 AUDIO LEVEL (CH-2) dial (p. 84)

10 AUTO/MAN (CH-2) switch (p. 84)

11 FOCUS (AUTO/MAN) switch —
PUSH AUTO button (p. 45)

12 H (headphones) jack

13 DC IN jack

14 Tripod receptacles (1/4 inch, 3/8 inch)
Supports 1/4-20UNC and 3/8-16UNC screws.

For mounting on a tripod with screw length 5.5 mm or shorter (sold separately).

The tripod may not be able to mount in some orientations, depending on the tripod specifications.

- 15** Accessory mounting screw holes
(1/4 inch)
Three locations on the handle, and eight
on the top panel.

For 1/4-20UNC screws (shorter than
6.5 mm)

Note
Using screws longer than 6.5 mm may
damage external parts.

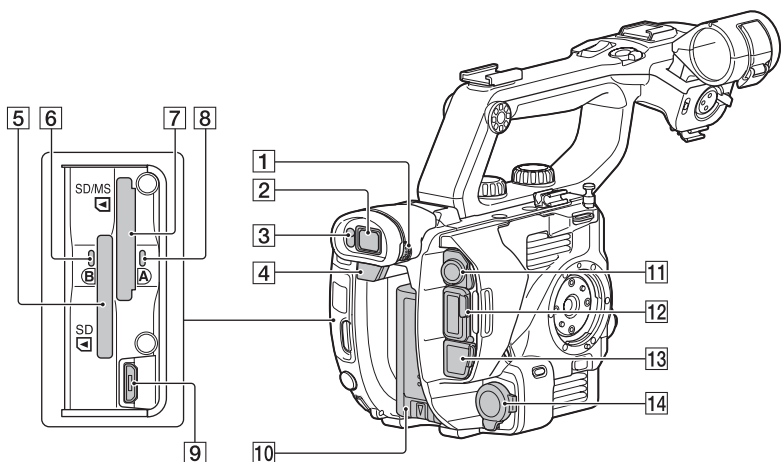

- 1** Diopter adjustment dial (p. 35)
2 Viewfinder (p. 35)
3 Eye sensor
4 BATT RELEASE button (p. 21)
5 Memory card slot B (p. 39)
6 Memory card access lamp (p. 3)
7 Memory card slot A (p. 39)
8 Memory card access lamp (p. 3)
9 Multi/micro USB jack (p. 124)
10 Battery pack (p. 21)
11 SDI OUT jack (p. 124)
12 HDMI OUT jack (p. 124)
13 Wired LAN port (p. 96)
14 INPUT 1 jack (p. 82)

Tip

- Although a GPS mark is displayed on the handle, GPS is a function that is planned for a future firmware update.

Identifying parts and controls (continued)

LCD screen

The numbers in () are reference pages.

For details about attaching the LCD screen, see page 29.

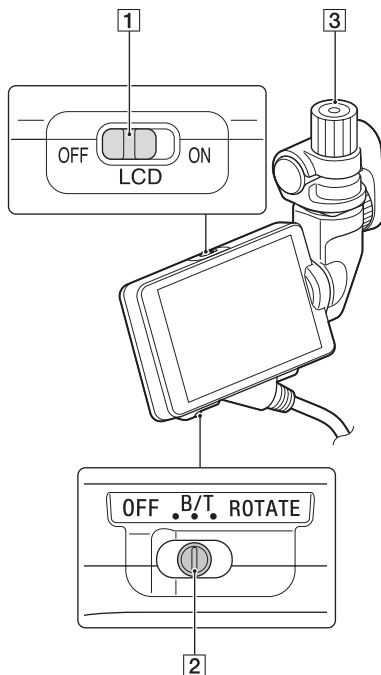

- 1** LCD ON/OFF switch (p. 34)
- 2** MIRROR switch (p. 114)
- 3** LCD screen mounting clamp

Lens (PXW-FS5M2K only)

For details, refer to the instruction manual supplied with the lens.

Grip

The numbers in () are reference pages.

For details about attaching the grip, see page 31.

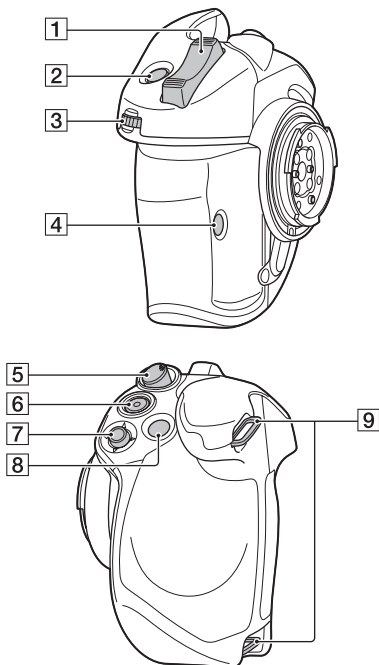

- 1** Grip zoom lever (p. 43)
- 2** ASSIGN4/FOCUS MAG button (p. 46)
- 3** ASSIGN dial (p. 85)
- 4** ASSIGN6 button (p. 85)
- 5** Grip rotate lever (p. 36)
- 6** START/STOP button (p. 40)
- 7** Multi-selector (p. 61)
- 8** ASSIGN5/Fn button (p. 61)

- 9** Grip belt attachment point
The grip belt is attached at the time of purchase.

Wireless Remote Commander

The numbers in () are reference pages.

Remove the insulation sheet before using the Wireless Remote Commander.

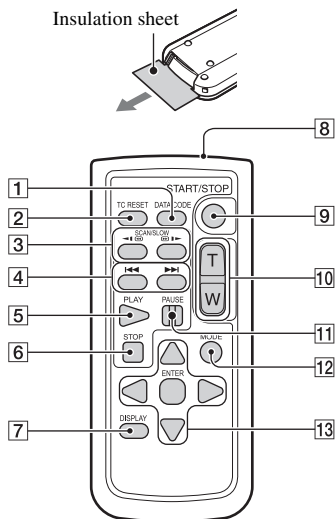

- 1** DATA CODE button (p. 122)
2 TC RESET button (p. 112)
3 SCAN/SLOW buttons (p. 119)
4 ◀▶ (PREV/NEXT) buttons (p. 119)
5 PLAY button (p. 119)
6 STOP button (p. 119)
7 DISPLAY button (p. 122)
8 Transmitter
9 START/STOP button (p. 40)
10 Zoom buttons (p. 43)
11 PAUSE button (p. 119)

- 12** MODE button (p. 119)

- 13** ◀▶/▲▼/ENTER buttons

Notes

- Aim the Wireless Remote Commander towards the remote sensor to operate your camcorder.
- Point the remote sensor away from strong light sources, such as direct sunlight or overhead lighting. Otherwise, the Wireless Remote Commander may not function properly.
- When you are operating with the Wireless Remote Commander supplied with your camcorder, your video device may also operate. In that case, select a commander mode other than DVD2 for your video device, or cover the sensor of your video device with black paper.

To change the battery of the Wireless Remote Commander

- 1** While pressing on the tab, inset your fingernail into the slit to pull out the battery case.
- 2** Place a new battery with the + side facing up.
- 3** Insert the battery case back into the Wireless Remote Commander until it clicks.

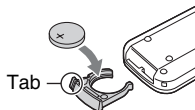

WARNING

Battery may explode if mistreated. Do not recharge, disassemble or dispose of in fire.

- When the lithium battery becomes weak, the operating distance of the Wireless Remote Commander may shorten, or the Wireless Remote Commander may not function properly. In this case, replace the battery with a Sony CR2025 lithium battery. Use of another battery may present a risk of fire or explosion.

Screen indicators

The numbers in () are reference pages.

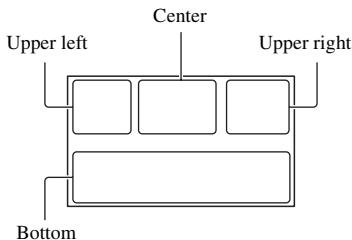

Upper left

Indicator	Meaning
100%	Remaining battery
AVCHD 1080/60i <u>FX</u> XAVC 1080/60i <u>50</u> XAVC 2160/30p <u>60</u>	REC FORMAT (p. 48)
	SIMUL/RELAY REC (p. 41, 42)
Zxx	Optical zoom (BAR) (p. 160)
	Optical zoom (NUMBER)
× xx	Clear Image Zoom (p. 150)
Px	PROXY REC MODE [ON] (p. 49)

Center





Indicator	Meaning
A B	Memory card (p. 38)
REC STBY	Recording status (p. 40)
	Warning (p. 176)
	Playback indicator (p. 119)
	Processing
A → B B → A	Relay recording (p. 41)
STBY REC	SDI/HDMI REC CONTROL (p. 155)

Upper right

Indicator	Meaning
Omin	Estimated remaining recording time (p. 178)
A B	Recording/playback media (p. 38)
00:00:00:00	Time code (hour:minute:second: frame) (p. 162)

Bottom

Indicator	Meaning
ON	Face detection [ON] (p. 47)
PEAKING	PEAKING (p. 158)
	ZEBRA (p. 158)
	NFC active (p. 88)
	AIRPLANE MODE (p. 96)
C.SCAN	CENTER SCAN (p. 150)
ASSIST S-LOG2	Gamma display assist (p. 111)
ASSIST S-LOG3	Gamma display assist (p. 111)
ASSIST HLG2020	Gamma display assist (when using HLG) (p. 58)
ASSIST HLG709	Gamma display assist (when using HLG) (p. 58)
	STEADYSHOT (p. 151)
-2.0EV	AE SHIFT (p. 149)
	Manual focus (p. 44)
PP1 to PP10	Picture profile (p. 103)
REC STBY AUTO	Multi-interface shoe video light (p. 151)
1/4ND to 1/128ND	ND filter (p. 53)
F5.6	Iris (p. 50)
ISO800	ISO sensitivity (p. 51)
9dB	Gain (p. 51)
100 180°	Shutter speed (p. 51)
	AVCHD AUDIO FORMAT (p. 155)

Indicator	Meaning
	Auto setting (p. 50)
	White balance (p. 55)
	HISTOGRAM (p. 158)
	AUDIO LEVEL DISPLAY (p. 160)
	Manual volume adjustment (p. 84)

Tip

- Indicators may look different or appear at different positions.

Data code during recording

For AVCHD, the recording date, time, and shooting conditions are recorded automatically.

They are not displayed while recording.

However, you can check them by selecting the data to display using  (DISPLAY SET) → [DATA CODE] (p. 161) or by pressing an ASSIGN button assigned with the DATA CODE function.

Table of Contents

Read this first	2
About upgrade licenses and firmware versions	5
Identifying parts and controls	6
Body	6
LCD screen	10
Lens (PXW-FS5M2K only)	10
Grip	10
Wireless Remote Commander	11
Screen indicators	12

Getting Started

Step 1: Checking supplied items	19
Step 2: Using a battery pack or AC Adapter	21
Step 3: Attaching the lens	23
Step 4: Attaching the handle, accessory shoe, microphone, LCD screen, and grip	26
Step 5: Turning on the camcorder and setting the date and time	33
Step 6: Adjusting the LCD screen and viewfinder	34
Step 7: Adjusting the angle of the grip	36
Step 8: Inserting a memory card	38

Recording

Recording	40
Recording	40
Continuous recording on the memory cards (Relay Rec)	41
Recording movies using both memory card A and B (Simul Rec)	42
Changing the setting of the START/STOP button and handle record button	42
Adjusting the zoom	43
Adjusting the focus	44
Using automatic focus/fixed focus temporarily (push auto focus/ focus hold)	45
Using the focus magnifier	46
Focusing on a detected face (Face detection)	47
Changing the recording setting/image size	48
Selecting the file format and recording format	48
Proxy recording	49
Adjusting the brightness	50
Adjusting the iris	50
Adjusting the ISO sensitivity/gain	51
Adjusting the shutter speed	51

To adjust the amount of light (ND filter)	53
Zebra 1 / Zebra 2	54
Adjusting the color tone	55
Adjusting the white balance	55
Adjusting the black balance	56
High Dynamic Range (HDR)	57
Shooting using HDR-compatible picture profile	57
Picture profile HDR-related items	57
Using the gamma display assist function	58
Playing video recorded in HDR on the camcorder	59
Limitations on HDR files recorded in non-XAVC formats	60
Using Direct Menu	61
Slow & Quick Motion/Super Slow Motion recording	63
Slow & Quick Motion recording	63
Recording in Super Slow Motion	65
Slow-Motion recording at High Frame Rate (HFR)	68
Preparing for High Frame Rate recording	68
Slow-motion recording at High Frame Rate	68
Limitations of High Frame Rate recording	69
Recording in RAW format using a RAW recorder (sold separately)	70
Preparing to record in RAW mode	70
Selecting RAW output and unit recording format	71
RAW 4K Super Slow Motion	72
RAW 2K Super Slow Motion	72
Setting the S&Q button for RAW	72
MPEG HD recording	73
Preparing to record in MPEG HD	73
Recording in MPEG HD	73
Slow & Quick Motion Recording	74
Super Slow Motion Recording	75
Playback in MPEG HD	76
MPEG HD output formats	77
Recommended memory cards	78
Estimated recording time of movies	78
Proxy recording supported formats	79
Streaming supported formats	80
About the MPEG format	81
Specifications	81
Audio setup	82
Recording sound from the internal microphone	82
Recording sound from an external audio device	83
Recording with a Multi-Interface Shoe-compatible microphone (sold separately)	83
Adjusting the audio recording level	84
Setting the Headphone Output	84
Assigning functions to the ASSIGN buttons/dial	85

Table of Contents (continued)

Using the Wi-Fi function	87
What you can do with the Wi-Fi function of the camcorder	87
Downloading "Content Browser Mobile"	87
Connecting the camcorder to an Android smartphone equipped with the NFC function using One-touch connection	88
Using a smartphone as a camcorder remote control	88
Connecting without using the NFC function (Android)	89
Connecting without using the NFC function (iPhone/iPad)	90
Using network functions	92
Configuring a wireless LAN	92
Using airplane mode	96
Configuring a wired LAN	96
Using the streaming function (STREAMING)	97
Using the FTP transfer function	99
Importing a root certificate	101
Resetting network settings	102
Useful functions	102
Selecting suitable settings automatically (full auto mode setting) ...	102
Customizing the picture quality (Picture profile)	103
Using the gamma display assist function	111
Setting time data	112
Preventing accidental operation (HOLD switch)	113
Reviewing the most recently recorded scene (Last Scene Review)	113
Inverting the LCD screen display	114
GPS function	115
GPS function compatible devices	115
Acquiring position information	115
GPS INFORMATION	116
AUTO CLOCK ADJ	116
AUTO AREA ADJ	117
About GPS	117









Playback

Playback	119
Playback	119
Changing/checking the settings in your camcorder	122
Changing the screen display	122
Displaying recording data (Data code)	122
Checking the camcorder settings (Status check)	123
Connecting to a monitor or a TV	124
Selecting jacks for external output	125
Output signal formats	125

Editing

Protecting recorded movies (Protect)	134
Dividing a movie	134
Deleting movies	135
Formatting a memory card	136
Preventing data on a memory card from being recovered	137
Repairing the image database file	138

Using the Menu

Operating the menu	139
Menu items	141
 (CAMERA/PAINT) menu	147
Settings to adjust your camcorder to the recording conditions (GAIN SET/  STEADYSHOT, etc.)	
 (REC/OUT SET) menu	153
Recording settings, input and output settings (REC SET/VIDEO OUT)	
 (AUDIO SET) menu	155
Settings for audio recording (AVCHD AUDIO FORMAT/XLR SET, etc.)	
 (DISPLAY SET) menu	158
Display settings (MARKER/DISPLAY OUTPUT, etc.)	
 (TC/UB SET) menu	162
Time code settings (TC PRESET/UB PRESET/TC FORMAT, etc.)	
 (NETWORK SET) menu	163
Settings for the Wi-Fi function (CTRL W/SMARTPHONE, etc.)	
 (SYSTEM) menu	164
Settings while recording or other basic settings (AREA SET/BEEP, etc.)	

Troubleshooting

Troubleshooting	168
Warning indicators and messages	176

Additional Information

Recording time	178
Function limitations when recording	180
Recording format limitations	180
Slow & Quick Motion and Super Slow Motion limitations	181
Proxy recording supported formats	182

Table of Contents (continued)

Streaming supported formats	183
Using your camcorder abroad	184
File/folder structure on the memory card	185
Maintenance and precautions	186
About the XAVC format	186
About the AVCHD format	186
About memory cards	186
About the battery pack	187
About handling of your camcorder	188
Specifications	191
Index	194

Step 1: Checking supplied items

Make sure that you have following items supplied with your camcorder. If, for any reason, there is something missing, contact your Sony dealer.

The number in brackets indicates the number of items supplied.

Battery pack (1)



AC Adapter/Charger (BC-U1A) (p. 22)



Power cord (mains lead) (p. 22)



Wireless Remote Commander (RMT-845) (p. 11)



A button-type lithium battery is already installed.

Large eyecup (p. 36)



Accessory shoe kit (Accessory shoe, Accessory shoe plate, screws [4]) (p. 27)

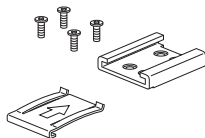

XLR handle (p. 26)

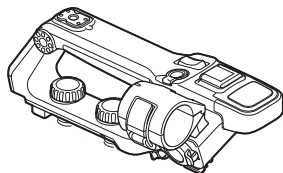

LCD screen (p. 29)

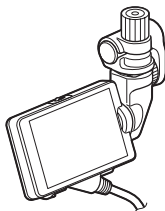

LCD screen protective sheet (p. 29)

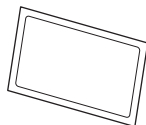

USB cable



Grip (p. 31)

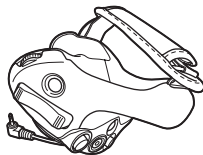

Body cap (attached to the camcorder) (p. 23)



Step 1: Checking supplied items (continued)

Handle connector protective cap (attached to the camcorder)

Grip attachment point cover (attached to the camcorder)

“Manuals for Solid-State Memory Camcorder” CD-ROM

Operating Guide [2]

A lens and lens hood are supplied with the PXW-FS5M2K.

Software Downloads

When the unit is used with a PC connection, download any device drivers, plug-ins, and application software you require from the following websites.

Sony Professional products website:

U.S.A. <http://pro.sony.com>

Canada <http://www.sonybiz.ca>

Latin America

<http://sonypro-latin.com>

Europe, Middle East and Africa

<http://www.pro.sony.eu>

Japan <http://www.sonybsc.com>

Asia Pacific

<http://pro.sony-asia.com>

Korea <http://bp.sony.co.kr>

China <http://pro.sony.com.cn>

Although the data regarding recorded materials are stored over multiple files and folders, you can easily handle the clips without considering the data and directory structure, by using the dedicated application software.

Step 2: Using a battery pack or AC Adapter

The camcorder can be powered by a battery pack or via an AC Adapter.

For safety, do not use power sources other than genuine Sony battery packs.

Lithium-ion battery packs

BP-U series*

* BP-U35 is supplied with this unit.

AC Adapter/Charger

BC-U1A (supplied)

BC-U2A

Notes

- Do not place the battery pack in hot locations, such as in direct sunlight or near naked flames.
- Use the supplied AC Adapter to power the camcorder from a power outlet.

Using a battery pack

- 1 Push the battery in and slide it down into position.

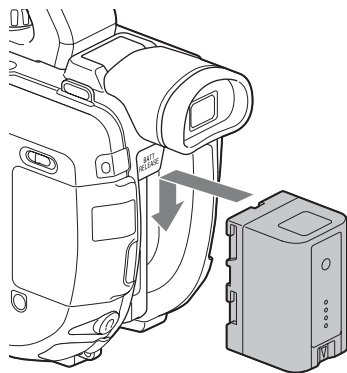

To remove the battery pack

Set the ON/STANDBY switch to STANDBY (⏻).

Press and hold the BATT RELEASE button, and slide the battery up and out.

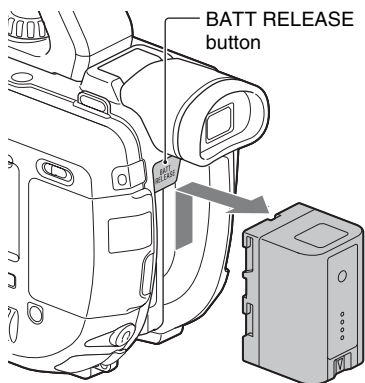

On the battery pack

- Always set the ON/STANDBY switch to STANDBY (⏻) before changing the battery pack.
- The Battery Info may not be correctly displayed under the following conditions.
 - The battery pack is not attached correctly.
 - The battery pack is damaged.
 - The battery pack is worn out.

Step 2: Using a battery pack or AC Adapter (continued)

Using a power outlet

You can use the AC Adapter to power the camcorder from a power outlet. While you are using the AC Adapter, the battery pack will not lose its charge even when it is attached to your camcorder.

Connection example: when connecting BC-U1A

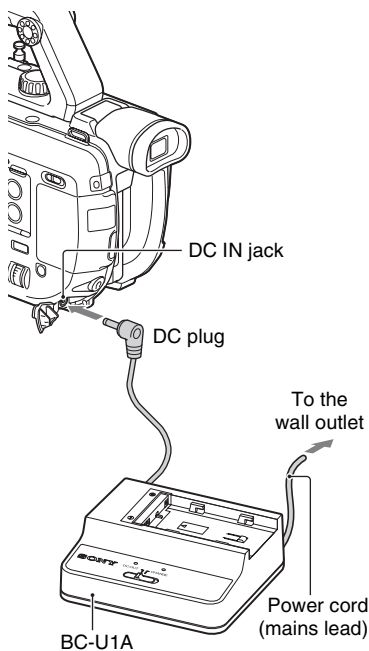

1 Connect the power cord to the AC Adapter.

2 Connect the AC Adapter to the DC IN jack of your camcorder.

3 Connect the power cord to the power outlet (wall socket).

4 Set the mode select switch on the BC-U1A to the DC OUT position.

Notes

- Do not short-circuit the DC plug of the AC Adapter or battery terminal with any metallic objects. This may cause a malfunction.
- The attached battery pack cannot be charged while the AC Adapter is connected.

Charging the battery pack

The battery pack can be charged using the BC-U1A battery charger.

For details about charging, refer to the manual for the battery charger.

Note

- Even if the CHG lamp is not lit, the battery charger is not disconnected from the AC power source (mains) as long as it is connected to the wall outlet (wall socket).

Step 3: Attaching the lens

This manual explains how to attach an SELP18105G lens. For details about using other lenses, refer to the manual supplied with your lens. Hold the camcorder body with the front end downward, and quickly change the lens somewhere away from dusty locations so as to keep dust or debris from getting inside the camcorder body.

- 1 Remove the body cap from the camcorder body and the rear lens cap from the lens.**

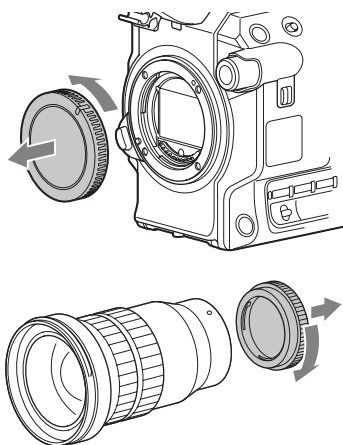

- 2 Mount the lens by aligning the mounting indexes (white) on the lens and the camcorder body. While pushing the lens lightly toward the camcorder body, turn the lens clockwise.**

The lens is attached when it clicks into the locked position.

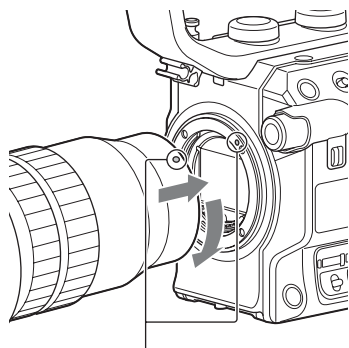

Mounting indexes (white)

Notes

- When attaching a lens, do not press the lens release button.
- Attach the lens to the camcorder squarely, without excessive force. Mounting the lens forcibly may result in a malfunction or damage of the lens mount and ND filter.
- There may be slight lens backlash when the lens is attached, depending on the lens used. This is not a fault.
- When attaching a heavy lens or a lens attached to a tripod, attach individual tripods to the lens and camera, as required, to maintain balance.

Tip

- After changing the lens, it is recommended to adjust the black balance (p. 56) before recording. When you adjust the black balance, make sure that the front lens cap is attached.

Removing the lens

- 1 While pressing the lens release button all the way in, turn the lens counterclockwise until it stops.**

When you remove the lens, make sure that you hold both of the lens and the camcorder body.

Step 3: Attaching the lens (continued)

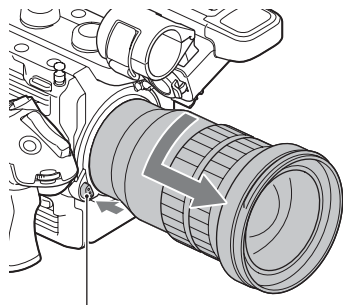

Lens release button

2 Replace the rear lens cap on the lens and attach the body cap to the camcorder body.

Align the mark on the body cap to the mounting index, and turn the cap clockwise.

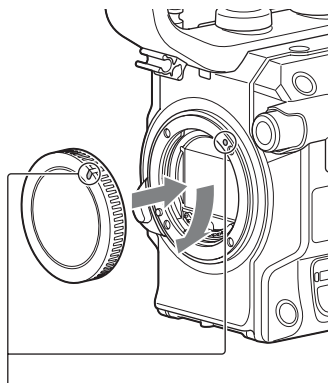

Align the marks.

Before you attach caps, remove dust from them.

⚠ Notes

- When changing the lens, if dust or debris adheres to the glass surface of the mount, it may appear on the image, depending on the shooting conditions. The glass surface of the mount has an anti-dust coating to prevent dust from adhering to the image sensor. However, attach or remove the lens quickly somewhere away from dusty locations.
- Do not leave the camcorder body with the lens or body cap removed.

If dust or debris adheres on the glass surface of the mount

Turn off the camcorder and detach the lens. Clean the glass surface of the mount and the surrounding area using a blower (sold separately), and then reattach the lens.

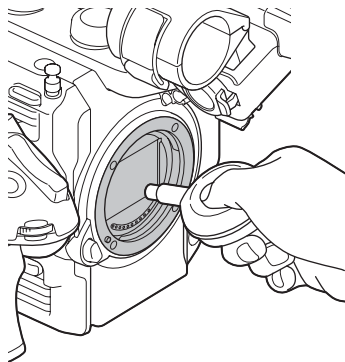

⚠ Notes

- Do not use a spray blower because it may scatter water droplets inside the camcorder body.
- Hold the camcorder's face downward to prevent the dust from resettling in the camcorder.
- If you cannot clean the glass surface of the mount by the above procedure, consult your Sony dealer or local authorized Sony service facility.

Mount adapters

Using a mount adapter (sold separately), you can attach an A-mount lens (sold separately) to your camcorder. For details, refer to the operating instructions supplied with the mount adapter.

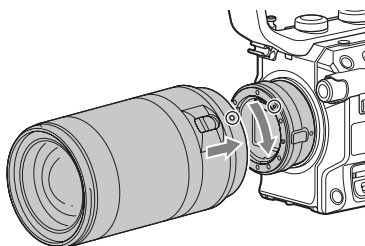
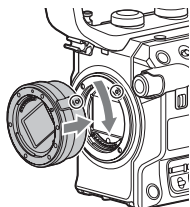

The available functions differ depending on the mount adapter type.

LA-EA1/LA-EA3

- The autofocus function is not supported.
- The iris can be adjusted using the ND/IRIS dial of the camcorder.

LA-EA2/LA-EA4

Function	
Autofocus	Continuous
AF system	Phase-detection AF
AF/MF select	SAM: Switchable on the lens SSM: Switchable on the lens and with the FOCUS switch of the camcorder Other lenses: Switchable with the FOCUS switch of the camcorder

Operations when using LA-EA2/LA-EA4

- Aperture is set to F3.5 when you record movies with autofocus. When you are using a lens with an F3.5 or smaller F-stop, aperture is set to the maximum F-stop of the lens. When you want to set your own value for aperture, select manual focusing. Adjusting the aperture during recording may cause noise or turn the LCD screen brighter.
- The iris will not adjust automatically in movie mode.

Notes

- Some lenses may not be usable or may have limited functionality. Check the dedicated support web site or consult your local authorized Sony service facility on compatible lenses.
- The sound of the lens and the camcorder in operation may be recorded during movie recording. You can avoid this by recording without the microphone, or by setting the AUTO/MAN (CH-1) switch or AUTO/MAN (CH-2) switch to "MAN" and the AUDIO LEVEL (CH-1, CH-2) dial to 0 (p. 82).
- It may take a long time or may be difficult for the camcorder to focus, depending on the lens used or the subject.

Step 3: Attaching the lens (continued)

AF area display

When using an A-mount lens with a mount adapter, the camcorder displays in-focus frames.

Autofocusing: The frame of the area that is in focus turns green.

Manual focusing: The frame of the area that is in focus turns green. This can assist focusing.

When using LA-EA2/LA-EA4

Autofocusing

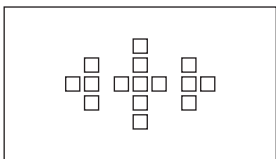

Manual focusing

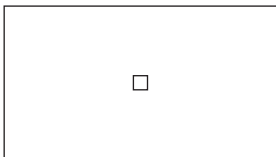

Note

- AF areas are not displayed during Super Slow Motion recording.

Step 4: Attaching the handle, accessory shoe, microphone, LCD screen, and grip

Attaching the handle

- 1** Remove the protective cap from the handle connector terminal.

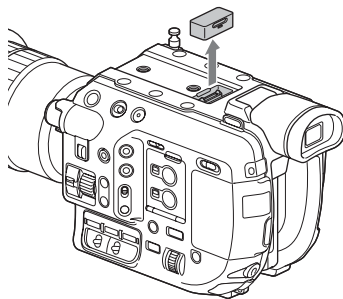

- 2** Place the handle in position, aligning the screws and connector with the camcorder.

- 3** While pressing each screw down, turn clockwise to fasten the handle.

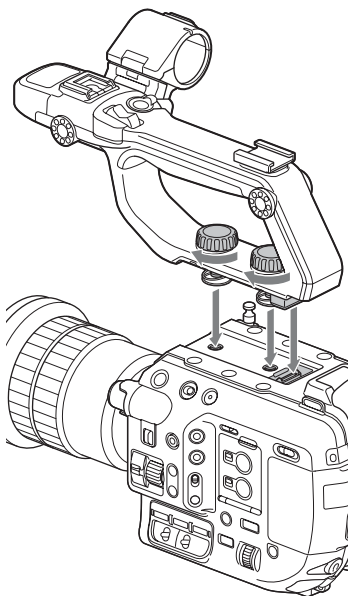

Note

- Make sure to securely tighten both handle mounting screws before use. The handle may uncouple, causing the camcorder to fall, if the unit is used without securely tightening the screws.

Removing the handle

Remove the handle using the reverse procedure for attaching.

Note

- When using the camcorder with the handle removed, attach the protective cap to the connector terminal to protect the connector.

Attaching the accessory shoe

- 1 Lift the edge of the accessory shoe plate and pull it in the direction opposite to that of the arrow on the accessory shoe and remove it from the accessory shoe.

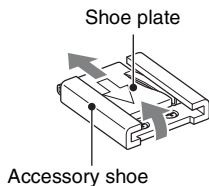

- 2 Place the accessory shoe with its protrusions matching the recesses on the accessory shoe mount, then fix it to the mount with the four screws.

Step 4: Attaching the handle, accessory shoe, microphone, LCD screen, and grip (continued)

- Insert the accessory shoe plate in the direction of the arrow on the plate surface until the end of the plate engages the end of the shoe.

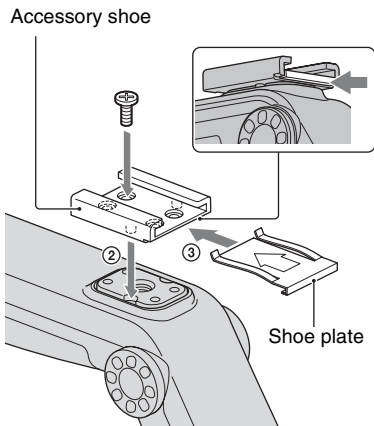

To remove the accessory shoe

Remove the shoe plate in the same way as described in step 1 of “Attaching the accessory shoe”.

Attaching the microphone (sold separately)

Attach the microphone holder to the handle.

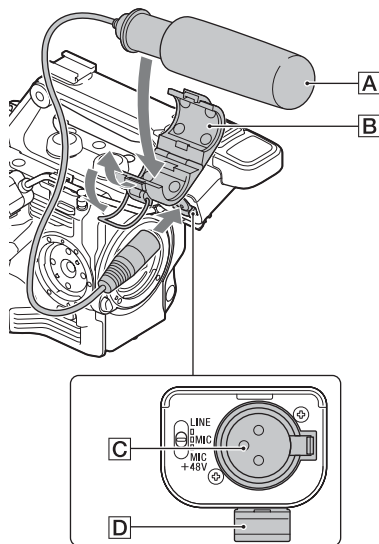

- Place the microphone **A** into the microphone holder **B**.
- Connect the plug of the microphone to the **INPUT 1** or **INPUT 2** jack **C**.
- Place the microphone cable into the cable holder **D**.

💡 Tips

- If the microphone cannot be attached securely, use the spacer supplied with the microphone.
- The tip of the microphone may appear in the picture, depending on the type of lens that is attached. Adjust the position of the microphone.

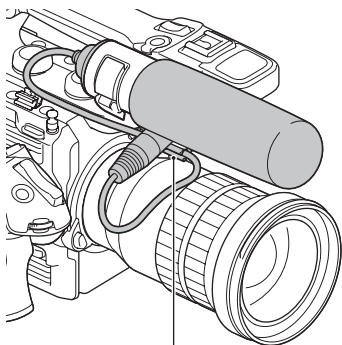

Put the cable in the outer cable holder.

Attaching the LCD screen

1 Insert the LCD screen mounting clamp into the LCD screen attachment point on the handle.

2 Turn the screw clockwise to fasten the clamp.

The mounting clamp can be secured at 45° increments, although it is recommended that the clamp be positioned directly above the screw.

Screw

LCD screen mounting clamp

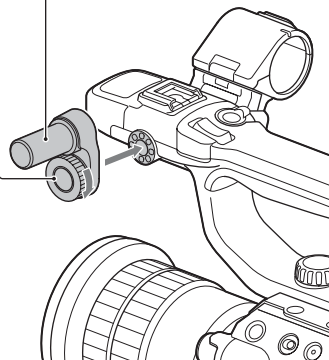

3 Attach the supplied protective sheet to the LCD screen as shown in the diagram.

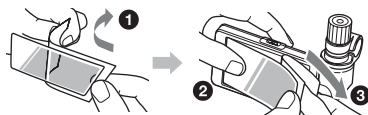

Note

- Wipe the LCD screen to remove any smudges or dust before attaching the protective sheet.

Tips

- When peeling the protective sheet off the LCD screen, it is recommended to use cellophane tape to help peel off the sheet.
- Small air bubbles may disappear naturally if left overnight.

4 Attach the LCD screen to the LCD screen mounting clamp.

Step 4: Attaching the handle, accessory shoe, microphone, LCD screen, and grip (continued)

- 5** Turn the lock knob clockwise to secure the LCD screen.

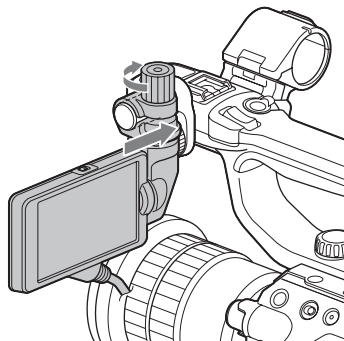

Note

- Securely tighten the LCD screen knob before use. The LCD screen may fall off if the unit is used without securely tightening the knob.

- 6** Align the “LCD▲” mark on the camcorder with the “▼” mark on the LCD screen connection jack, and plug in the cable.

Check the cable orientation to make sure the ▼ faces outwards, and then insert the cable.

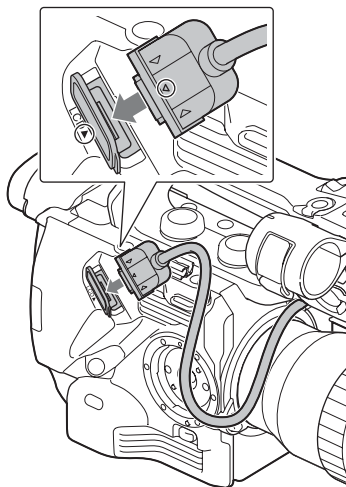

To remove the cable

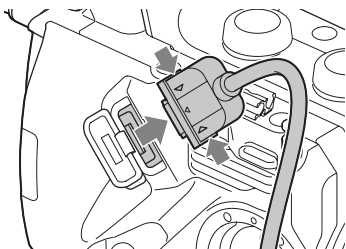

Press both sides (▶ and ◀) of the LCD screen connection jack, and then remove the connector.

To change the angle of the LCD screen

See “Step 6: Adjusting the LCD screen and viewfinder” (p. 34).

To attach the LCD screen to different positions on the handle

There are also LCD screen attachment points on the back of the handle (2 locations). The attachment procedure is the same as described in “Attaching the LCD screen”.

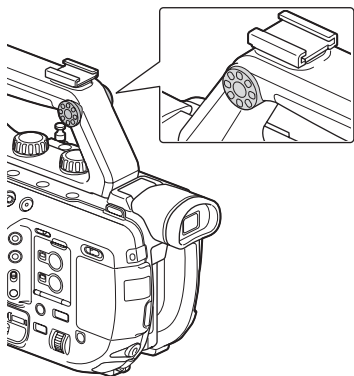

Removing the LCD screen

Remove the LCD screen using the reverse procedure of attaching.

Attaching the grip

- 1 Remove the grip attachment cover.

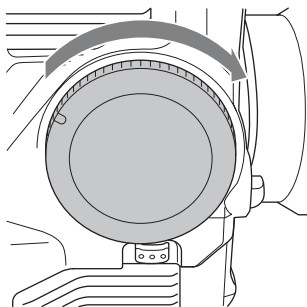

- 2 Connect the cable to the REMOTE jack.

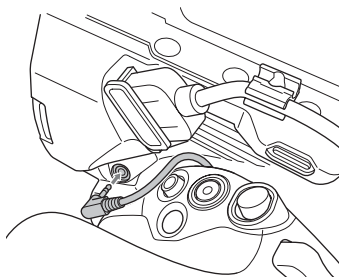

- 3 Align the grip mounting index with the attachment point index on the camcorder, and turn the grip counterclockwise gently.

Indexes

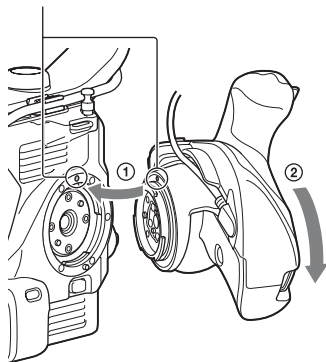

The grip is attached when it clicks into the locked position.

Note

- If the grip does not attach correctly, try to attach the grip again without using excessive force.

Step 4: Attaching the handle, accessory shoe, microphone, LCD screen, and grip (continued)

- 4 Insert the cable connected in step 2 into the slot on the side of the grip as shown in the diagram.

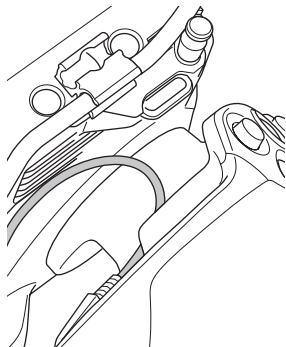

Note

- If the cable is not inserted in the slot, undue force may be applied to the cable when changing the mounting angle of the grip or the cable may become snagged in the rotation mechanism.

Removing the grip

- 1 Disconnect the cable from the **REMOTE** connector.
- 2 Press and hold the grip release button on the camcorder, and turn the grip clockwise until it detaches.

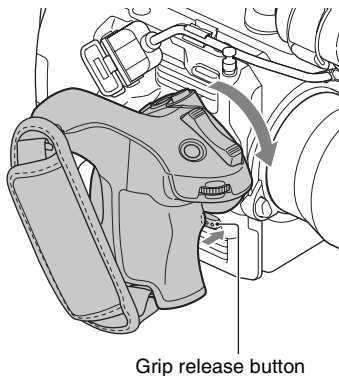

Note

- Always place the camcorder on a desk or other horizontal surface when removing the grip.

Tip

- You can attach rosettes to the grip attachment point on the camcorder and to the mounting point on the grip.
Rosette mount components are available from Sony dealers or service representatives.
 - Camcorder side: 4-546-932 (sold separately)
 - Grips side: 4-547-089 (sold separately)
 - Mounting screws: 7-627-556 (sold separately)*
- * 4 screws/rosette are required.
(screw holes indicated by ○ in the following diagram)

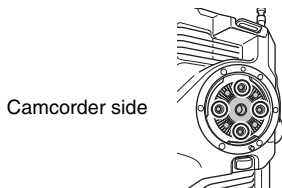



Step 5: Turning on the camcorder and setting the date and time

Turning on the camcorder

Set the **ON/STANDBY** switch on (I).

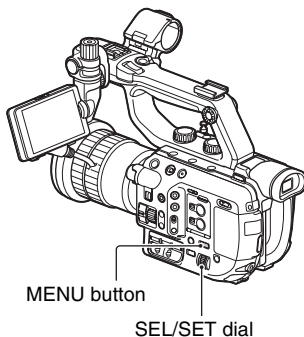
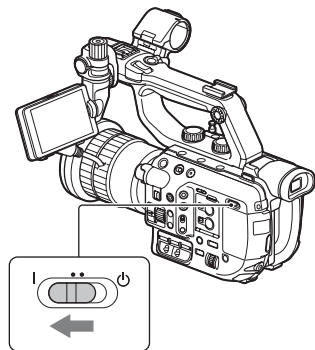
When you use your camcorder for the first time, the [CLOCK SET] screen appears.



To set the date and time again, press the MENU button, and select  (SYSTEM) → [CLOCK SET].

To turn off the power

Set the ON/STANDBY switch to STANDBY (⏻).

Note

- If messages appear on the LCD screen, follow the instructions.

Setting the date and time

Set the date and time when you use your camcorder for the first time.

Tip

- If you do not use your camcorder for about **2 months**, the built-in rechargeable battery gets discharged and the date and time settings may be cleared from the memory. In that case, charge the rechargeable battery and then set the date and time again (p. 189).

1 Select your area by turning the SEL/SET dial, then press the dial.

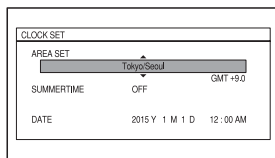

2 Set [SUMMERTIME], [Y] (year), [M] (month), [D] (day), hour and minute, by turning the SEL/SET dial, then press the dial.

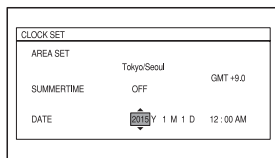

The clock starts.

- Set [SUMMERTIME] to [ON] to move the time forward 1 hour.

Step 5: Turning on the camcorder and setting the date and time (continued)

- You can set any year up to the year 2037.
- Midnight is indicated as 12:00 AM, and noon as 12:00 PM.

Tip

- The date and time are automatically recorded on the selected memory card, and can be displayed during playback (p. 161).

Changing the language setting

You can change the on-screen displays to show messages in a specified language. Press the MENU button and select  (SYSTEM) with the SEL/SET dial. Select the screen language in [LANGUAGE] (p. 165).

Setting [60i/50i SEL]

Select [60i/50i SEL] beforehand, according to the area in which you will use the camcorder.

To change the setting, press the MENU button and select  (SYSTEM) → [60i/50i SEL] with the SEL/SET dial (p. 166).

Step 6: Adjusting the LCD screen and viewfinder

Switching between the LCD screen and the viewfinder

You can select whether to use the LCD screen or the viewfinder using the following settings.

To use the LCD screen only

LCD screen	LCD screen "LCD ON/OFF" switch	[VF/LCD PANEL] menu setting
Connected	ON	LCD PANEL

* See page 161.

To switch between LCD screen and viewfinder automatically

LCD screen	LCD screen "LCD ON/OFF" switch	[VF/LCD PANEL] menu setting
Connected	ON	AUTO

This setting enables switching to viewfinder display automatically whenever your eye is near the eye sensor (p. 9) on the side of the viewfinder.

When you move your eye away from the viewfinder, the display switches back to the LCD screen.

Notes

- The default setting of [VF/LCD PANEL] is [LCD PANEL].
- The LCD screen and the viewfinder cannot be used at the same time.

Tip

- The eye sensor will respond if the eye sensor is blocked, even if you are not looking into the viewfinder.

To use the viewfinder only

LCD screen	LCD screen "LCD ON/OFF" switch	[VF/LCD PANEL] menu setting
Connected	OFF	–
Not connected	–	–

Adjusting the LCD screen

The LCD screen can be turned up, down, forwards, or backward to any angle for easy viewing.

The LCD screen display orientation can be controlled using the MIRROR switch (p. 114).

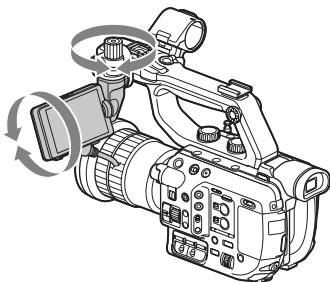

💡 Tip

- The LCD screen should be closed when the camcorder is not in use or when it is being moved to protect the LCD screen.

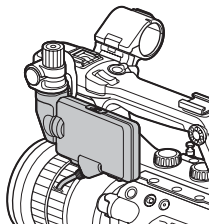

Adjusting the viewfinder

To adjust the viewfinder angle

You can adjust the angle of the viewfinder to suit your shooting style.

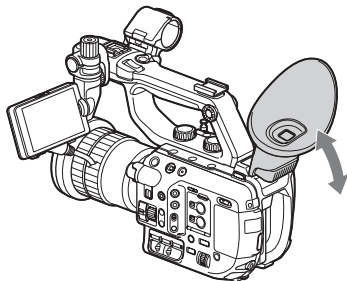

To adjust the focus of the viewfinder display

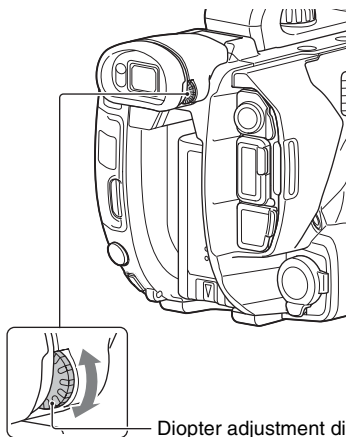

Diopter adjustment dial
Move it until the image
becomes clear.

Step 6: Adjusting the LCD screen and viewfinder (continued)

When the picture in the viewfinder is hard to see

If you cannot see the picture in the viewfinder clearly under bright circumstances, use the supplied large eyecup. To attach the large eyecup, stretch it slightly and fit it over the groove of the eyecup attached to the camcorder. You can attach the large eyecup facing either the right or left side.

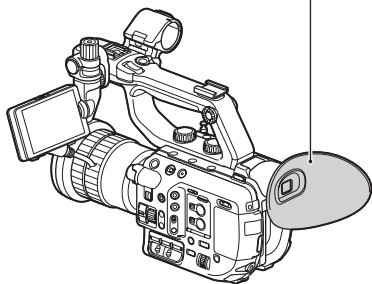
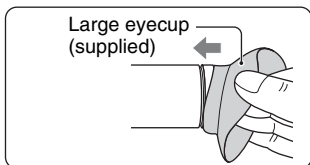

Note

- Do not remove the eyecup pre-attached to the camcorder.

Step 7: Adjusting the angle of the grip

You can adjust the angle of the grip to suit your shooting style.

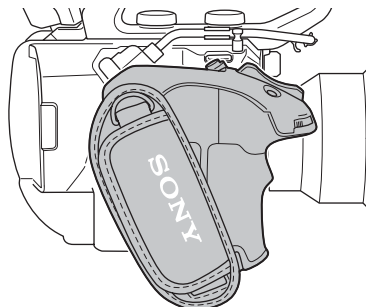

Normal position

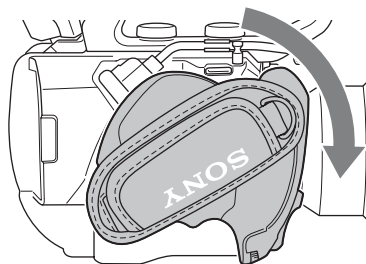

Rotated toward the lens
(maximum rotation)

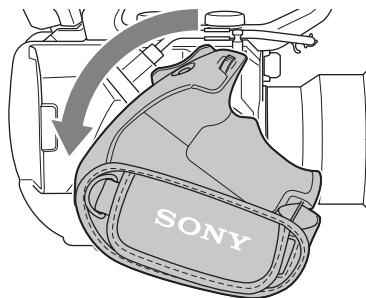

Rotated toward the rear
(maximum rotation)

- 1 Move the grip rotate lever to the position shown below, and turn the grip while pressing the lever.

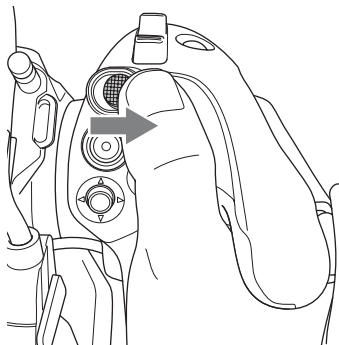

- 2 Release the grip rotate lever when the grip is near the desired position.

- 3 Move the grip slightly until it clicks into the locked position.

When the grip is locked, move the grip rotate lever back to its original position.

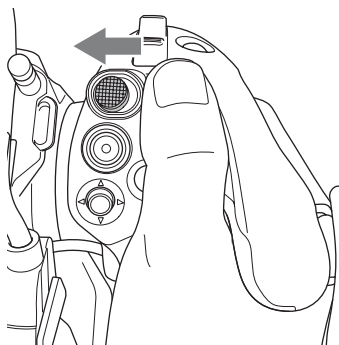

Notes

- When finished, always check that the grip is locked in position.
- The angle cannot be adjusted beyond the adjustment range. Do not use force to try and rotate the grip.

Holding the grip (recommended method)

The recommended way of holding and operating the grip is shown below.

Using the ASSIGN5/Fn button and multi-selector

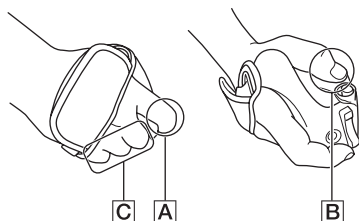

- A** Operate the ASSIGN dial using your index finger.
- B** Operate the multi-selector and ASSIGN5 button using your thumb.
- C** Hold the grip firmly using your middle finger, ring finger, and little finger.

Zooming in/out

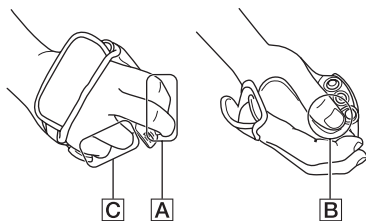

- A** Operate the zoom lever using your index finger and middle finger.
- B** Hold the grip firmly using your thumb.

Step 7: Adjusting the angle of the grip (continued)

- Ⓒ Hold the grip firmly using your ring finger and little finger.

Step 8: Inserting a memory card

Supported memory cards

File format	Supported memory cards
AVCHD	SD, SDHC, SDXC memory card (Class 4 or U1 or faster) Memory Stick PRO Duo (Mark2), Memory Stick PRO-HG Duo
AVCHD (Slow & Quick Motion, Super Slow Motion)	SDHC, SDXC memory card (Class 10 or U1 or faster) Memory Stick PRO-HG Duo
XAVC HD	SDXC memory card (Class 10 or U1 or faster)
XAVC HD (Slow & Quick Motion, Super Slow Motion)	SDXC memory card (U3)
XAVC QFHD	SDXC memory card (Class 10 or U1 or faster) ^{*1}
XAVC QFHD (Slow & Quick Motion)	SDXC memory card (U3)
XAVC HD/ Proxy simultaneous recording	SDXC memory card (Class 10 or U1 or faster) ^{*2}
XAVC QFHD/ Proxy simultaneous recording	SDXC memory card (U3)

^{*1} SDXC UHS Speed Class (U3) is required to record at 100 Mbps.

^{*2} SDXC memory card (U3) is required for simultaneous XAVC HD (50 Mbps) and proxy (9 Mbps) recording.

🔗 Notes

- Operation with all memory cards is not assured.
- Only “Memory Stick PRO Duo” media and “Memory Stick PRO-HG Duo” media, which are half the size of standard “Memory Stick” media, or standard size SD cards can be used with this camcorder.

- See page 178 for the recording time of memory cards.
- Movies recorded on SDXC memory cards cannot be imported to or played back on computers or A/V devices not supporting the exFAT file system used for SDXC memory cards, by connecting the camcorder to these devices with the USB cable. Confirm in advance that the connecting equipment supports the exFAT file system. If you connect equipment not supporting the exFAT file system and the format screen appears, do not perform the format. All the data recorded will be lost.

Open the cover, and insert the memory card with the notched corner in the direction as illustrated until it clicks into place.

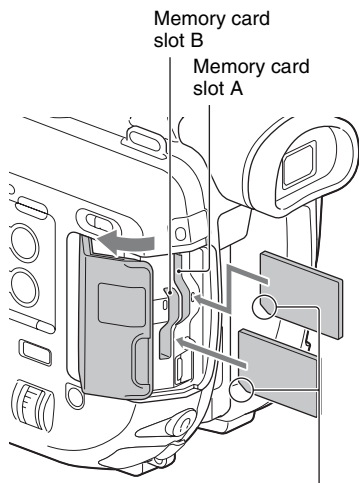

Note the direction of the notched corner.

- If you insert a memory card into the slot in the wrong direction, the memory card, the memory card slot, or image data may be damaged.
- Memory card slot A accepts either "Memory Stick PRO Duo" media, "Memory Stick PRO-

HG Duo" media, or an SD card. Memory card slot B accepts an SD card only.

To eject the memory card

Lightly push the memory card once.

Notes

- If [The image database file is corrupted. The media must be restored to use again.] appears, format the memory card (p. 136).
- When inserting or ejecting the memory card, be careful of the memory card popping out and dropping.

Selecting the memory card slot to be used for recording

Press the SLOT SEL button to change which slot is selected for recording. You can confirm the selected slot on the screen.

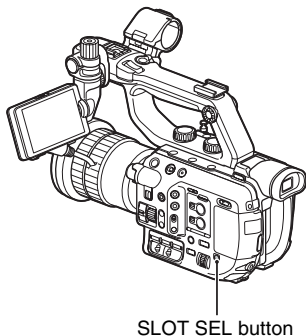

Notes

- You can only select a slot that already has a memory card inserted.
- While movies are being recorded on the memory card, you cannot switch the slot even if you press the SLOT SEL button.

Tip

- When only one slot has a memory card inserted, the slot that has the memory card is selected automatically.

Recording

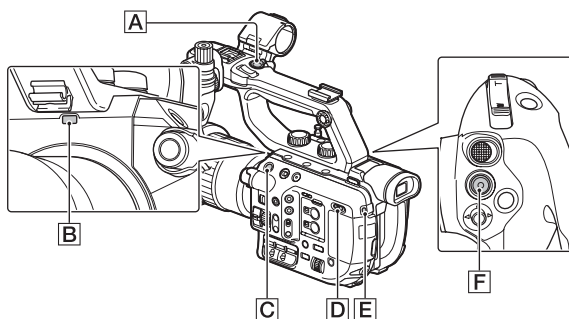

Recording

Your camcorder records movies on memory cards. Do the following steps to record.

1 Set the ON/STANDBY switch **D** to ON (I).

2 Press a record button **A C F** to begin recording.

(In the following descriptions, the “record button” refers collectively to the handle record button, START/STOP button on the camcorder, and START/STOP button on the grip.)

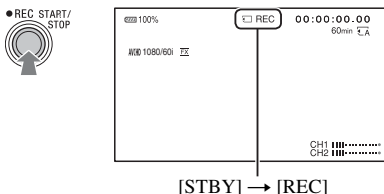

The recording lamps **B E** light up during recording.

To stop recording, press the record button again.

Notes

- See page 178 about the recording time.
- If a movie file size exceeds 2 GB while recording in AVCHD format, the camcorder automatically divides the file and creates a new one.
- The menu settings, the picture profile settings, and the settings made by the FULL AUTO button are stored in your camcorder when you slide the ON/STANDBY switch to STANDBY (⏻). The memory card access lamp lights up while the settings are being stored. If you remove the battery pack or the AC Adapter before turning off the power, the settings return to the previous settings.

💡 Tips

- For details about changing the screen display during recording, see page 122.
- Indicators displayed on the LCD screen during recording are shown on page 12.
- The recording lamp can be set to stay off ([REC LAMP[F]], [REC LAMP[R]], page 166).

Continuous recording on the memory cards (Relay Rec)

Insert memory cards each in both slots A and B so the camcorder switches memory card A (or B) just before the remaining space on the other one runs out, and continues recording on the next memory card automatically.

Do the following setting before recording.

Select \Rightarrow (REC/OUT SET) \rightarrow [REC SET] \rightarrow [SIMUL/RELAY REC] \rightarrow [RELAY REC].

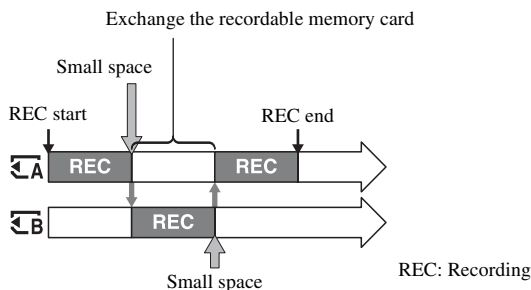

📌 Notes

- Relay recording (Relay Rec) is not supported when using the following functions.
 - Slow & Quick Motion
 - Super Slow Motion
 - Streaming
- Do not eject the memory card that is currently being used for recording. When replacing a memory card while recording, replace only the one in the slot whose memory card access lamp is off.
- Even if you press the SLOT SEL button, while recording movies, you cannot switch the slot currently being used.
- When the remaining recording time of the memory card being used is less than 1 minute and the other slot has a recordable memory card inserted, [$\overline{\text{A}} \rightarrow \overline{\text{B}}$] or [$\overline{\text{B}} \rightarrow \overline{\text{A}}$] appears on the camcorder screen. The indicator turns off when the memory card is switched.
- If you start recording on a memory card with the remaining recording time of less than 1 minute, the camcorder may not be able to relay-record. To relay-record without failing, make sure that the memory card has more than 1 minute when you start recording.
- Seamless playback of relay-recorded movies with this camcorder is not supported.
- The maximum recording time using relay recording in both XAVC and AVCHD is 13 hours. Recording stops automatically when the maximum recording time elapses.

Recording movies using both memory card A and B (Simul Rec)

You can record movies on both memory card A and memory card B simultaneously. Do the following setting before recording.





Select  (REC/OUT SET) → [REC SET] → [SIMUL/RELAY REC] → [SIMULTANEOUS REC].

Note

- Simultaneous recording (Simul Rec) is not supported when using the following functions.
 - Slow & Quick Motion
 - Super Slow Motion
 - Streaming









Changing the setting of the START/STOP button and handle record button

When using SIMULTANEOUS REC, you can start and stop recording on different memory cards by using the START/STOP buttons (camcorder and grip) and the handle record button. In the default setting, movies are recorded on both the memory card A and B at the same time when either record button is pressed.

- REC BUTTON (START/STOP buttons on camcorder and grip):  , 
- HANDLE REC BUTTON:  , 

To change the setting

Select  (REC/OUT SET) → [REC SET] → [REC BUTTON SETTING].

REC BUTTON SETTING setting	Button and memory card
REC BUTTON:  ,  HANDLE REC BUTTON:  , 	Recording on both the memory card A and the memory card B starts and stops at the same time when either record button is pressed.
REC BUTTON:  HANDLE REC BUTTON: 	Recording on the memory card A starts and stops when the START/STOP button is pressed, and on the memory card B when the handle record button is pressed.
REC BUTTON:  HANDLE REC BUTTON: 	Recording on the memory card B starts and stops when the START/STOP button is pressed, and on the memory card A when the handle record button is pressed.

Adjusting the zoom

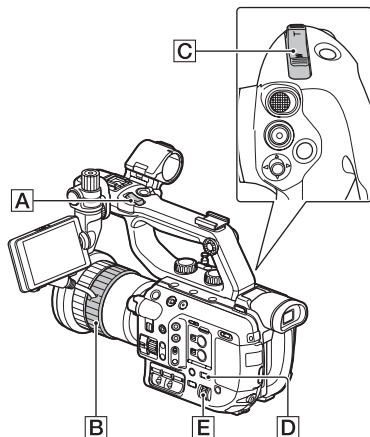

Selecting the zoom type

1 Press the MENU button **D**.

2 Select (CAMERA/PAINT) → [ZOOM SET] → [ZOOM TYPE] → zoom type with the SEL/SET dial **E**.

The zoom type varies as shown below, depending on the type of the attached lens.

Attached lens	[ZOOM TYPE] setting	
	OPTICAL ZOOM ONLY	ON[CLEAR IMAGE ZOOM]
Fixed focal length lens / zoom lens	Zoom using zoom lever not supported.	Clear image zoom supported.

Attached lens	[ZOOM TYPE] setting	
	OPTICAL ZOOM ONLY	ON[CLEAR IMAGE ZOOM]
Power zoom lens	Optical zoom only	Optical zoom and clear image zoom supported.

Tip

- CLEAR IMAGE ZOOM is a zoom function that features little or no degradation in image quality.

Adjusting the zoom with the zoom lever

Press the handle zoom lever **A** or grip zoom lever **C** slightly to zoom slowly, and press it further to zoom more quickly.

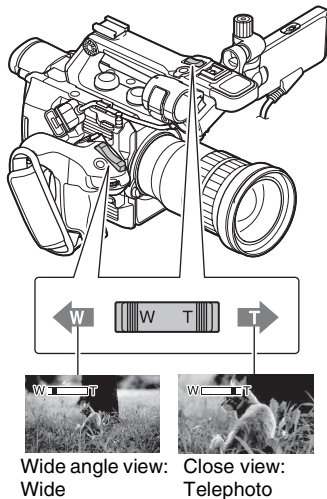

Tip

- Keep your finger on the power zoom lever. If you remove your finger, the operation sound of the power zoom lever may also be recorded.

- You can change the handle zoom lever function ([HANDLE ZOOM], p. 150).
- You can switch the zoom display between a bar indicator and number indicator ([ZOOM DISPLAY], p. 160)

Adjusting the zoom with the zoom ring

You can zoom at the desired speed by turning the zoom ring **[B]**. Fine adjustment is also possible.

Note

- Turn the zoom ring **[B]** at a moderate speed. If you turn it too fast, the zoom may lag behind the zoom ring rotation, or the operation sound of the zoom may also be recorded.

Turn the zoom ring right or left to decide on the size of the subject in your image. Zooming must be done before focusing. When using a power zoom lens, you can also zoom with the zoom lever of the lens.

Notes

- The available operations and operating methods depend on the lens attached. Refer to the operating manual that comes with your lens.
- Do not grab or apply a strong force to the lens cylinder as it rolls out when zooming. The lens may be damaged.
- Keep your finger on the zoom lever. If you move your finger off the zoom lever, the operation sound of the zoom lever may also be recorded.

Adjusting the focus

You can adjust the focus manually for different recording conditions.

Use this function in the following cases.

- To record a subject behind a window covered with raindrops.
- To record horizontal stripes.
- To record a subject with little contrast between the subject and its background.
- When you want to focus on a subject in the background.

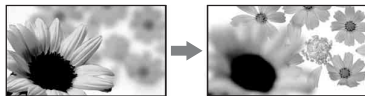

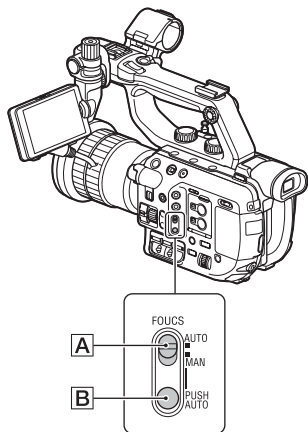

- To record a stationary subject using a tripod.



- 1** During recording or standby, set the FOCUS (AUTO/MAN) switch **[A]** to “MAN.”

 appears.

2 Rotate the focus ring and adjust the focus.



 changes to  when the focus cannot be adjusted any farther, and changes to  when the focus cannot be adjusted any closer.

To adjust automatically

Set the FOCUS (AUTO/MAN) switch  to “AUTO.”

 disappears and the automatic focus adjustment is restored.

Tips

- Can be operated using Direct Menu (p. 61).
- You can assign this function to the ASSIGN dial (p. 85).
- The focal length information (for when it is dark and hard to adjust the focus) appears for about 3 seconds in the following cases.
 - When you set the FOCUS (AUTO/MAN) switch  to “MAN” and  appears on the LCD screen.
 - When you rotate the focus ring while  is displayed on the LCD screen.
- You can switch the focal length information between meters and feet ([FOCUS DISPLAY], p. 160).

To measure the precise recording distance

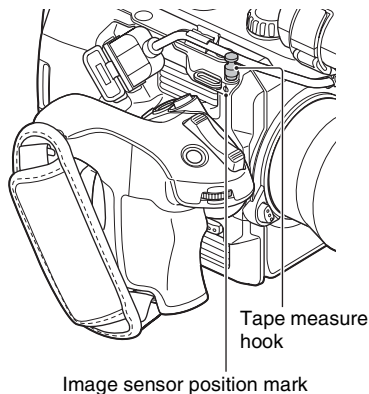

The image sensor position mark and tape measure hook are on the same plane as the image sensor. To measure the precise distance between the camcorder and the subject, use this mark or tape measure hook as a reference.



You can attach the end of a tape measure to the hook, and measure the distance from the subject.

Note

- You cannot focus on a subject closer to the lens than the minimum focus distance of the lens used. Make sure you are not too close to the subject.

Using automatic focus/fixes focus temporarily (push auto focus/focus hold)

To use push auto focus

Set the FOCUS (AUTO/MAN) switch  to “MAN,” then press and hold the PUSH AUTO button .

The image is shot with automatic focus. Keep the button pressed to shoot. If you

Adjusting the focus (continued)

release the button, the setting returns to manual focusing.

To use focus hold

Set the FOCUS (AUTO/MAN) switch **A** to "AUTO," then press and hold the PUSH AUTO button **B**.

The image is shot with the focus fixed at the point you start to press the button. Keep the button pressed to shoot. If you release the button, the setting returns to auto focusing.

Note

- If the lens has the same function button as your camcorder, the function on the lens works the same as your camcorder. For example, when focus hold is active on your camcorder, the button on the lens functions as focus hold.

Using the focus magnifier

The selected area on the LCD screen is magnified and displayed. This is useful when adjusting the focus.

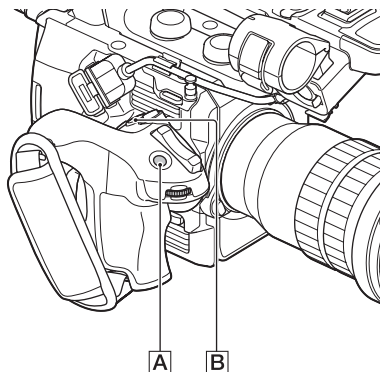

Press the FOCUS MAG button **A** on the grip.

The setting changes with each press of the button.

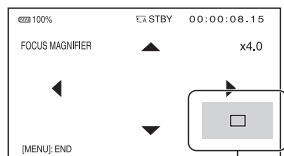

Enlarged display position

You can change the position of the enlarged display using the multi-selector **B** on the grip or the SEL/SET dial on the camcorder. Press the multi-selector **B** or SEL/SET dial to set the enlarged display position back to the center.

Note

- Even though the image appears enlarged on the LCD screen, the recorded image is not enlarged.

Tips

- You can assign this function to an ASSIGN button (p. 85).
- You can change the magnification ratio with [FOCUS MAG RATIO] (p. 159).

Focusing on a detected face (Face detection)

The camcorder detects faces and focuses on one of them (default setting is [OFF]). You can use this function when the FOCUS (AUTO/MAN) switch **A** is set to "AUTO."

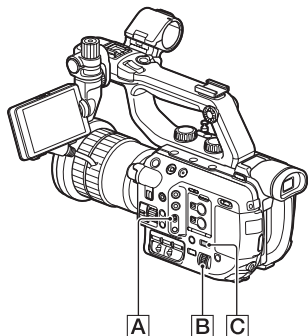

1 Press the MENU button **C**.

2 Select  (CAMERA/PAINT) → [FACE DETECTION] → [ON] with the SEL/SET dial **B**.

Faces are detected.

When the faces are detected, frames appear on the LCD screen.

3 Move the selection cursor (orange colored frame), and select the priority face with the SEL/SET dial **B**, then press the dial.

Selection cursor (orange colored frame)



Priority face frame (double frame)

The frame on the priority face changes to a double frame.

To cancel face detection

Move the selection cursor (orange colored frame) onto the frame (double frame) on the priority face, using the SEL/SET dial **B**, then press the dial.

⚙ Notes

- Faces may not be detected depending on the recording environment, the condition of the subject or the settings.
- You may not be able to get the proper effect in some recording environments. If this happens, set [FACE DETECTION] to [OFF].
- When [FACE DETECTION] is set to [ON], you cannot adjust shutter speed, etc. To adjust shutter speed, etc., set [FACE DETECTION] to [OFF] temporarily by setting the FOCUS (AUTO/MAN) switch **C** to "MAN."
- The face detection function is not available while using clear image zoom.
- For details about other limitations, see "Function limitations when recording" (p. 180).

💡 Tips

- You can assign this function to an ASSIGN button (p. 85).
- To make it easy to detect faces, record under the following conditions:
 - Record in a moderately bright place
 - Do not obscure the face with a hat, mask, sunglasses, etc.
 - Face the front of the camera

Changing the recording setting/image size

Selecting the file format and recording format

You can select the file format in [FILE FORMAT] and the recording format (bit-rate, image size, frame rate, and scanning system) in [REC FORMAT].

You can select either XAVC QFHD, XAVC HD, or AVCHD for the file format on the camcorder. (For details about RAW format recording, see page 70.)

Change the image quality according to the recording situation or the playback device.

1 Press the MENU button.

2 Select \rightleftarrows (REC/OUT SET) → [REC SET] → [FILE FORMAT] → a desired format with the SEL/SET dial.

3 Select \rightleftarrows (REC/OUT SET) → [REC SET] → [REC FORMAT] → a desired format with the SEL/SET dial.

XAVC QFHD (4K mode)

60i	50i
2160/30p 100Mbps	2160/25p 100Mbps
2160/30p 60Mbps	2160/25p 60Mbps
2160/24p 100Mbps	—
2160/24p 60Mbps	—

- Image size: 2160 (3840×2160)
- Frame rate: 30/25/24
- Scanning system: p (progressive)
- Bit rate: 100 Mbps/60 Mbps

XAVC HD

60i	50i
1080/60p 50Mbps	1080/50p 50Mbps
1080/60p 35Mbps	1080/50p 35Mbps
1080/60i 50Mbps	1080/50i 50Mbps
1080/60i 35Mbps	1080/50i 35Mbps
1080/60i 25Mbps	1080/50i 25Mbps
1080/30p 50Mbps	1080/25p 50Mbps
1080/30p 35Mbps	1080/25p 35Mbps
1080/24p 50Mbps	—
1080/24p 35Mbps	—
720/60p 50Mbps	720/50p 50Mbps

- Image size: 1080 (1920×1080) / 720 (1280×720)
- Frame rate: 60/50/30/25/24
- Scanning system: p (progressive) / i (interlaced)
- Bit rate: 50 Mbps/35 Mbps/25 Mbps

AVCHD

60i	50i
1080/60p PS	1080/50p PS
1080/60i FX	1080/50i FX
1080/60i FH	1080/50i FH
1080/30p FX	1080/25p FX
1080/30p FH	1080/25p FH
1080/24p FX	—
1080/24p FH	—
720/60p FX	720/50p FX
720/60p FH	720/50p FH
720/60p HQ	720/50p HQ

- Image size: 1080 (1920×720) / 720 (1280×720)
- Frame rate: 60/50/30/25/24
- Scanning system: i (interlaced) / p (progressive)
- Bit rate

PS: max. 28 Mbps

FX: max. 24 Mbps

FH: approx. 17 Mbps (average)

HQ: approx. 9 Mbps (average)

Frame rate when [60i] is selected

The frame rate displayed on the camcorder corresponds to the values in the following table.

Frame rate on the LCD screen	Actual frame rate
24	23.98
30	29.97
60	59.94

Note

- For details about other limitations in each recording format, see “Function limitations when recording” (p. 180).

Proxy recording

This function allows you to simultaneously record a low bitrate proxy file at the same time as recording the high bitrate original file movie.

Function limitations when proxy recording

Some functions on the camcorder are unavailable when proxy recording. For details, see “Function limitations when recording” (p. 180).

Proxy recording supported formats

Proxy recording is supported only when [FILE FORMAT] is set to XAVC QFHD or XAVC HD. Proxy recording is not available when set to AVCHD. There are limitations on the size of the original file movie and the proxy file movie.

For details, see “Proxy recording supported formats” (p. 182).

Proxy recording

For details about media that support proxy recording, see “Supported memory cards” (p. 38).

1 Press the MENU button.

2 Select \Rightarrow (REC/OUT SET) \rightarrow [REC SET] \rightarrow [PROXY REC MODE] \rightarrow [ON/OFF] \rightarrow [ON] with the SEL/SET dial.

Px appears on the screen.

3 Select \Rightarrow (REC/OUT SET) \rightarrow [REC SET] \rightarrow [PROXY REC MODE] \rightarrow [SIZE] \rightarrow desired image size with the SEL/SET dial.

4 Press the record button to begin recording.

Note

- The camcorder can no longer record when the maximum number of XAVC files is reached (600).

About proxy recording files

- For details about the storage location of proxy recording files, see “File/folder structure on the memory card” (p. 185).
- Proxy files cannot be played on the camcorder. Px appears on the thumbnail of the original file.
- A proxy file is also deleted/protected when the corresponding original file is deleted/protected.

Adjusting the brightness

You can adjust the brightness by controlling the amount of light, etc., using iris, ISO sensitivity/gain, shutter speed, or ND filter.

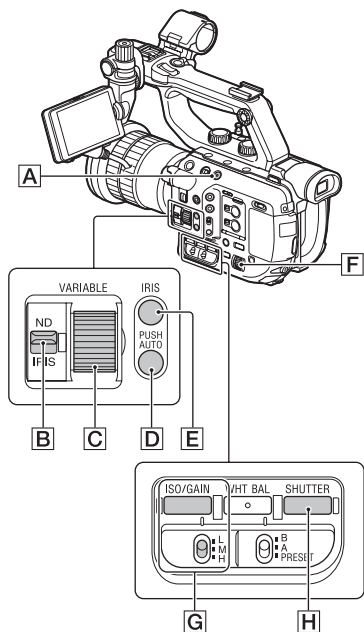

Note

- When you set the FULL AUTO button on (lit), the iris, ISO sensitivity/gain, shutter speed, and white balance are adjusted automatically. You cannot adjust them manually.

Adjusting the iris

- 1 Press the FULL AUTO button **A** to set full auto mode off.

- 2 Press the IRIS button **E**.

A next to the iris value disappears.

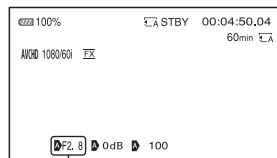

Iris value

- 3 Set the ND/IRIS switch **B** to the "IRIS" position.

- 4 Turn the ND/IRIS dial **C** to adjust the value.

The volume of the light increases the more that you open the aperture (decreasing F value). The volume of the light decreases the more that you close the aperture (increasing F value).

To temporarily adjust the iris automatically

Press and hold the IRIS PUSH AUTO button **D**.

The iris is adjusted automatically for as long as you hold the button down.

To adjust automatically

Press the IRIS button **E**.

A appears next to the iris value.

💡 Tips

- Can be operated using Direct Menu (p. 61).
- You can assign this function to the ASSIGN dial (p. 85).
- The range of focus, an important effect of the aperture, is called the depth of field. The depth of field gets shallower as the aperture is opened,

and deeper as the aperture is closed. Use the aperture creatively to obtain the desired effect in your photography.

- You can assign [IRIS PUSH AUTO] to an ASSIGN button (p. 85).

Adjusting the ISO sensitivity/gain

You can adjust the ISO sensitivity and gain manually.

- 1 Press the **FULL AUTO** button **[A]** to set full auto mode off.

- 2 Press the **ISO/GAIN** button **[G]**. **[A]** next to the ISO value or gain value disappears.

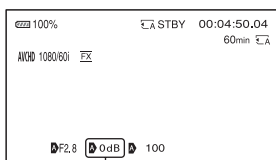

ISO value/gain value

- 3 Set the **ISO/GAIN L/M/H** switch **[G]** to the desired position.

The set ISO value or gain value appears. You can set the value for each L/M/H switch position using [ISO SET] or [GAIN SET] in the **[CAMERA/Paint]** menu (p. 148).

To adjust automatically

Press the **ISO/GAIN** button **[G]**. The ISO value or gain value disappears, or **[A]** appears next to the ISO value or gain value.

Tips

- Can be operated using Direct Menu (p. 61).
- You can assign this function to the ASSIGN dial (p. 85).
- You can switch the displayed value between ISO sensitivity and gain using [ISO/GAIN SEL] in the menu. Note that ISO sensitivity and gain are separately saved with different values (p. 147).

Adjusting the shutter speed

You can adjust and fix the shutter speed manually. You can make a moving subject look still or emphasize the fluid motion of a moving subject by adjusting the shutter speed.

- 1 Press the **FULL AUTO** button **[A]** to set full auto mode off.

- 2 Press the **SHUTTER SPEED** button **[H]** to highlight the shutter speed value.

[A] next to the shutter speed value disappears.

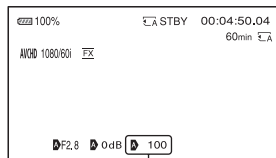

Shutter speed value

3 Turn the SEL/SET dial **[F]** to adjust the shutter speed.

The following shutter speed adjustment ranges are available:

When [60i] is selected:

1/8 to 1/10000

(1/6 to 1/10000 when shooting with 24p)

When [50i] is selected: 1/6 to 1/10000

The denominator of the set shutter speed appears on the LCD screen. For example, [100] appears on the LCD screen when you set the shutter speed to 1/100 second. The larger the value on the LCD screen is, the faster the shutter speed is.

4 Press the SEL/SET dial **[F]** to apply the shutter speed.

To readjust the shutter speed, repeat the procedure from step 2.

Tips

- Can be operated using Direct Menu (p. 61).
- It is difficult to focus automatically at a lower shutter speed. Manual focusing with your camcorder attached to a tripod is recommended.
- When recording under fluorescent lamps, sodium lamps, or mercury lamps, the picture may flicker or change colors, or may have horizontal bands of noise.
You may be able to improve the situation by adjusting the shutter speed to 1/50 if the power frequency of your area is 50 Hz, or 1/60 in a 60 Hz area.
- You can switch the shutter speed display between seconds and degrees ([SHUTTER DISPLAY], page 160).

To adjust automatically

Press the SHUTTER button **[H]** twice. The shutter speed value disappears, or **[A]** appears next to the shutter speed value.

Setting value after switching [60i/50i SEL]

The shutter speed of the same level before changing the [60i/50i SEL] setting is applied. See the following table for the shutter speeds on each level.

Level	60i/60p/30p	24p	50i/50p/25p
0	–	6	–
1	8	12	6
2	15	24	12
3	30	25	25
4	50	40	30
5	60	48	50
6	90	50	60
7	100	60	100
8	125	96	120
9	180	100	150
10	250	120	215
11	350	144	300
12	500	192	425
13	725	200	600
14	1000	288	1000
15	1500	400	1250
16	2000	576	1750
17	3000	1200	2500
18	4000	2400	3500
19	6000	4800	6000
20	10000	10000	10000

To adjust the amount of light (ND filter)

The camcorder features two ND filter modes. You can switch between the two modes using the PRESET/VARIABLE switch **B**.

Adjusting in preset mode

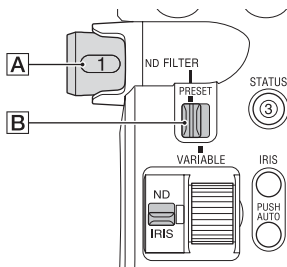

Set the PRESET/VARIABLE switch **B** to “PRESET,” and switch the ND FILTER dial **A** as described below.

CLEAR: No ND filter

1: Density set in CAMERA/PAINT → ND FILTER → PRESET1.

Default is 1/4.

2: Density set in CAMERA/PAINT → ND FILTER → PRESET2.

Default is 1/16.

3: Density set in CAMERA/PAINT → ND FILTER → PRESET3.

Default is 1/64.

Adjusting in variable mode

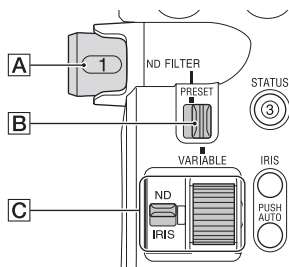

1 Set the ND/IRIS switch **C** to the “ND” position.

2 Set the PRESET/VARIABLE switch **B** to “VARIABLE,” and switch the ND FILTER dial **A** to position 1, 2, or 3.

3 Adjust the filter density in the range 1/4 to 1/128 with the ND/IRIS dial **C**.

The ND FILTER dial **A** 1/2/3 positions have no effect on the filter density adjustment.

💡 Tips

- Can be operated using Direct Menu (p. 61).
- You can assign this function to the ASSIGN dial (p. 85).
- If you switch ND FILTER dial **A** during recording, the image or sound may become distorted.
- When shooting a bright subject, diffraction (a common phenomenon in video cameras, caused by closing the iris too much) may result in poor focusing. Using the ND FILTER dial **A** suppresses this phenomenon for better shooting images.

Adjusting the brightness (continued)

Setting auto ND filter

* On the PXW-FS5, this function is supported using Ver. 2.0 or later (see page 5).

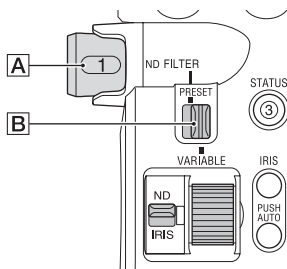

1 Set the PRESET/VARIABLE switch **B** to VARIABLE, and switch the ND FILTER dial **A** to position 1, 2, or 3.

The ND filter mode is set to variable mode.

2 Set (CAMERA/PAINT) → [ND FILTER] → [AUTO ND FILTER] to ON in the menu.

 (auto) appears on the icon indicating the ND filter value.

Notes

- Switching the auto ND filter on/off is supported in variable mode only.
- When the camcorder is in preset mode or when the ND FILTER dial **A** is set to CLEAR, the auto ND filter is disabled.
- When full auto mode is on in variable mode, the density of the ND filter is adjusted automatically, even if the auto ND filter is off.

Tips

- You can assign the auto ND filter ON/OFF setting to an ASSIGN button.

- Can be operated using Direct Menu.

However, when full auto mode is on, operating the ND filter using the ASSIGN button or Direct menu is not supported.

Zebra 1 / Zebra 2

* On the PXW-FS5, this function is supported using Ver. 2.0 or later (see page 5).

- Zebra 1: Set a reference level and range for zebra display.
- Zebra 2: Display zebra above a set level.

Setting zebra



Select  (DISPLAY SET) → [ZEBRA] in the menu, and set the following items.

Item	Settings (default setting in bold)
[ZEBRA SELECT]	OFF , ZEBRA1, ZEBRA2
[ZEBRA1 LEVEL] *1	0% to 109% (1% increments) (70%)
[ZEBRA1 APERTURE LEVEL] *2	2% to 20% (2% increments) (10%)
[ZEBRA2 LEVEL] *3	0% to 109% (1% increments) (100%)

*1 Zebra 1 level (reference level)

*2 Zebra 1 range

*3 Zebra 2 level (minimum level)

When ZEBRA1 or ZEBRA2 is selected, the  icon or  icon appears.

Notes

- Zebra 1 and zebra 2 cannot be displayed at the same time.
- Zebra is not recorded onto the memory card.
- When [ZEBRA SELECT] is OFF, the zebra point of the histogram is not displayed.

Tip

- You can assign [ZEBRA] to an ASSIGN button. The setting switches to OFF → ZEBRA1 → ZEBRA2 each time you press the button.

Adjusting the color tone

Adjusting the white balance

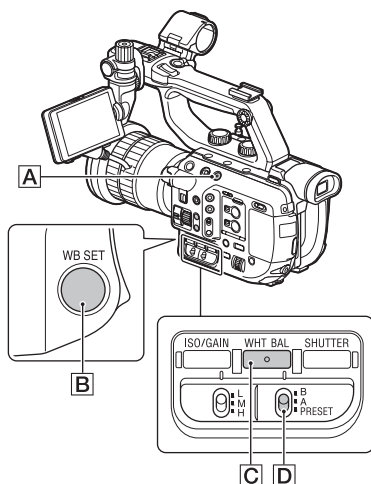

You can adjust and set the white balance according to the lighting conditions of the recording environment.

💡 Tips

- You can assign [WB PRESET] to an ASSIGN button (p. 85).
- Can be operated using Direct Menu (p. 61).

1 Press the **FULL AUTO** button **A** to set full auto mode off.

2 Press the **WHT BAL** button **C** to display the **WHT BAL** indicator.

3 Set the **B/A/PRESET** switch **D** to the desired position.

■ Setting the A/B value

Select A or B for recording with the white balance setting (p. 56) stored in memory A or B.

- When using a commercially available ND filter, this adjustment is recommended.



■ To use the PRESET value of white balance

Select (CAMERA/PAINT) → [WB PRESET] and select a desired setting.

Setting value	Example of recording conditions
Outdoor ([OUTDOOR])	<ul style="list-style-type: none">• When recording a night scene, neon lighting, fireworks, etc.• When recording a sunrise, sunset, etc.• Under daylight fluorescent lamp
Indoor ([INDOOR])	<ul style="list-style-type: none">• Where lighting conditions change, such as at a party place, etc.• Under video light, such as in a studio, etc.• Under a sodium or mercury lamp
Color temperature setting ([MANU WB TEMP])	<ul style="list-style-type: none">• You can set a desired color temperature between 2300K and 15000K with (CAMERA/PAINT) → [WB TEMP SET] (default setting is 6500K).

Adjusting the color tone (continued)







Tips

- You can change the white balance value for outdoor locations when set to  (OUTDOOR). Press the WB SET button  and turn the SEL/SET dial. Select a value in the range -7 (bluish) to 0 (standard, default value) to +7 (reddish).



You can also set the white balance from the menu ([WB OUTDOOR LEVEL], page 149).

- You can change the color temperature when set to [MANU WB TEMP]. Press the WB SET button  and turn the SEL/SET dial. You can also set the white balance from the menu ([WB TEMP SET], page 149).

To save the adjusted white balance value in memory A or B

- ① Press the FULL AUTO button  to set full auto mode off.
- ② Press the WHT BAL button  to display the WHT BAL indicator.
- ③ Select A ( A) or B ( B).
- ④ Frame a white object, such as a piece of paper, that fills the screen under the same lighting conditions as your subject.
- ⑤ Press the WB SET button .
The adjusted value is stored in  A or  B. The stored color temperature appears for about 3 seconds.

Notes

- When a white balance adjustment value has not been obtained successfully,  A or  B flashes slowly. Adjust the subject appropriately and set the shutter speed to auto or around 1/60 (1/50), then try adjusting the white balance again.
- It may take a long time to adjust the white balance, depending on the recording conditions. If you want to perform a different operation before completing the adjustment, set the B/A/PRESET switch  to another position to stop the white balance adjustment.

To restore automatic adjustment

Press the WHT BAL button .

Adjusting the black balance

Normally, you do not need to adjust the black balance. The black balance may be inappropriately adjusted for some recording situations. If that happens, adjust the black balance. It is recommended that you adjust the black balance also when you change the lens.

The adjusted settings are stored.

- 1 Press the MENU button during standby.
- 2 Select  (CAMERA/PAINT) → [BLACK BALANCE] with the SEL/SET dial.
- 3 Following the message on the LCD screen, attach the front lens cap, and select [YES].
The black balance adjustment starts.
- 4 When [Completed.] appears, press the MENU button to complete the adjustment.

If [Could not adjust.] appears

- ① Press the MENU button to close the menu screen.
- ② Try the procedure again from step 1.

High Dynamic Range (HDR)

* On the PXW-FS5, this function is supported using Ver. 4.0 or later (see page 5).

Reproduction of brightness over a wider range than previously available is now supported by applying an HDR-compatible picture profile. The camcorder supports Hybrid Log-Gamma (HLG), with four selectable settings.

The [HLG] setting is equivalent to ITU-R BT.2100. The [HLG1], [HLG2], and [HLG3] settings enable images to be reproduced with a wider dynamic range without images that appear unnatural, as can arise in existing camera image reproduction.

Shooting using HDR-compatible picture profile

1 Select  (CAMERA/PAINT) menu → [PICTURE PROFILE] → [PP10].

Picture profile number	Example setting
PP10	Setting for shooting in HDR

2 Adjust the picture profile items, as required.

3 Press the record button.

Movies shot in HDR are recorded on the memory card.

Notes

• For XAVC recording

When recording HDR video in XAVC format on the camcorder, the color space, gamma, and other metadata required for HDR playback and

display are stored in the video file.

On devices used for playback and display that support the metadata, the video is displayed automatically with the appropriate settings. On devices that do not support the metadata, manual configuration is required.

• For AVCHD recording / MPEG HD recording

AVCHD format recordings and MPEG HD format recordings do not support HDR metadata. For appropriate playback and display of HDR, manual configuration is required.

Picture profile HDR-related items

The following items have been added.

[GAMMA] items

(Default setting in bold)

Item	Description
[HLG]	Setting equivalent to ITU-R BT.2100.
[HLG1]	Setting that provides greater noise suppression than [HLG2]. However, the dynamic range that can be shot is narrower.
[HLG2]	Setting with balance between dynamic range and noise suppression.
[HLG3]	Setting that provides wider dynamic range than [HLG2]. However, the noise level rises.

[HLG1], [HLG2], and [HLG3] all use the same gamma curve characteristic. Only the dynamic range and noise suppression characteristics differ.

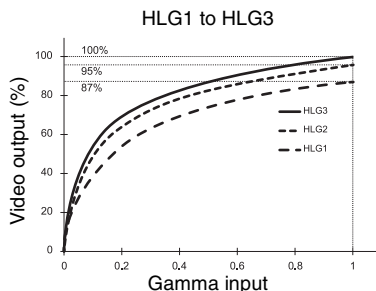

Notes

- The maximum value of the video output varies depending on whether [HLG1], [HLG2], or [HLG3] is selected ([HLG1]: 87%, [HLG2]: 95%, [HLG3]: 100%). Test shooting beforehand is recommended to prevent use of an inappropriate setting during actual shooting.
- The following limitations apply when [HLG], [HLG1], [HLG2], or [HLG3] is selected.
 - If [MODE] is set to AUTO for [KNEE], the [KNEE] setting becomes disabled.
 - [COLOR MODE] can only be set to [BT.2020] or [709].
 - The [BLACK GAMMA] setting is disabled.
 - [AUTO BACK LIGHT] cannot be used.

[COLOR MODE] items

(Default setting in bold)

Item	Description
[BT.2020]	Standard color tone when [HLG], [HLG1], [HLG2], or [HLG3] is selected for [GAMMA].
[709]	Color tone for recording HDTV format (BT.709) color when [HLG], [HLG1], [HLG2], or [HLG3] is selected for [GAMMA].

Note

Color bars are not output correctly when [BT.2020] is selected.

Using the gamma display assist function

The viewfinder and LCD screen of the camcorder do not support HDR, and so are not appropriate for displaying HDR. However, they can display an image to aid shooting using the gamma display assist function.

The gamma display assist function affects only the monitoring video or playback video displayed in the viewfinder or on the LCD screen. The recorded video and output video are not affected.

1 Select  (DISPLAY SET) menu
→ [GAMMA DISP ASSIST] →
[ON/OFF] → [ON].

2 Select [GAMMA DISP ASSIST] →
[TYPE].

3 Select one of the following.

(Default setting in bold)

Item	Description
[AUTO]	<p>Shooting screen: Automatically corrects the picture according to the picture profile setting.</p> <p>Playback screen: For AVCHD, MPEG HD, and XAVC non-HLG files, automatically corrects the picture according to the current picture profile setting. For XAVC HLG files, automatically corrects the picture according to the gamma and color mode of the playback image.</p> <p>Thumbnail screen: Maintains the recent setting (shooting/playback).</p>
[HLG (BT.2020)]	Applies suitable correction for when [GAMMA] is HLG and [COLOR MODE] is set to [BT.2020].
[HLG(709)]	Applies suitable correction for when [GAMMA] is HLG and [COLOR MODE] is set to [709].



* Requires the MPEG HD option.

Tip

When the camcorder is powered using the battery pack, changing the brightness of the LCD will make the HDR image easier to monitor. In the DISPLAY SET menu, select [LCD BRIGHT] → [BRIGHT].

Icon display

When the gamma display assist function is ON, the following icons are displayed on the shooting screen and playback screen.

Icon	Meaning
	[HLG(BT.2020)] in use
	[HLG(709)] in use

Playing video recorded in HDR on the camcorder

You can play back video recorded in HDR on the camcorder.

When playing files recorded in XAVC QFHD or XAVC HD format, an “HLG” icon is displayed on the thumbnail screen and playback screen (see following diagrams).

Notes

- An “HLG” icon is not displayed when playing AVCHD or MPEG HD format files recorded in HDR.
- The HDMI output and SDI output do not support HDR metadata. For appropriate display of HDR, manual configuration is required.

Thumbnail screen

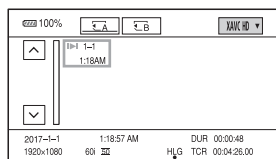

* Only files recorded in XAVC format.

Playback screen

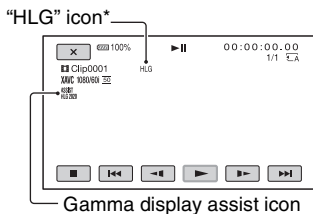

* Only files recorded in XAVC format.

Limitations on HDR files recorded in non-XAVC formats

The following limitations apply on files recorded in formats other than XAVC-QFHD or XAVC HD.

- The fact that the recording used HLG is not registered in metadata.
- The “HLG” icon is not displayed on the thumbnail screen and playback screen.

Using Direct Menu

Direct Menu allows you to change menu settings using single-hand operation from the grip.

The following settings can be changed using Direct Menu.

- Focus (p. 44)
- AE shift level value (p. 149)
- ND filter value (p. 53)
- Iris value (p. 50)
- ISO sensitivity/gain (p. 51)
- Shutter speed value (p. 51)
- White balance value (p. 55)

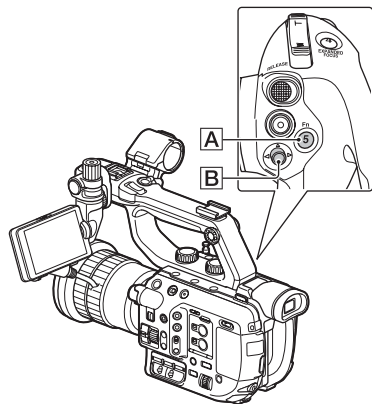

1 Press the ASSIGN5 button **A** on the grip.

By default, the Direct Menu function is assigned to the ASSIGN5 button **A**, but it can also be assigned to other buttons.

After entering Direct Menu mode, a cursor (underline) is displayed for items along the bottom of the LCD screen.

- Orange cursor indicates the selected item.
- White cursor indicates selectable items.

For example, the iris value **4** is selected in the following diagram.

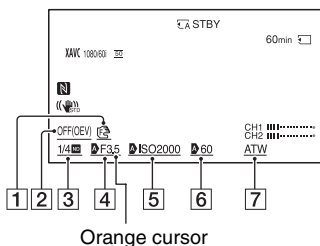

- Orange cursor
- 1 Focus value
 - 2 AE shift level value
 - 3 ND filter value
 - 4 Iris value
 - 5 ISO sensitivity/gain
 - 6 Shutter speed value
 - 7 White balance value

2 Move the multi-selector **B** left/right to move the orange cursor to select the target item to set.

3 When **A** (auto) appears for the item to set, moving the multi-selector up/down clears the **A** mark.

4 Press the multi-selector [B] to select the setting.

The set value is highlighted in reverse black and white, allowing you to change the value.

The following diagram shows an example of changing the shutter speed value.

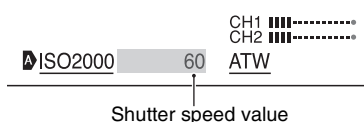

5 Move the multi-selector [B] up/down to display the desired value.

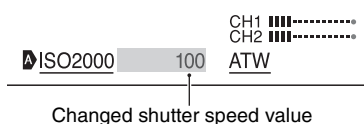

6 To set another item, repeat steps 3 to 5 to move the orange cursor using the left/right keys.

7 When all desired values are displayed, press the multi-selector [B].

The setting is applied, and Direct Menu mode ends.

- During thumbnail display
- Slow & Quick Motion
- Super Slow Motion
- FOCUS MAGNIFIER
- FACE DETECTION
- LAST SCENE REVIEW
- VOLUME
- Smartphone operation (CTRL W/ SMARTPHONE)
- STREAMING

- If an item (such as iris value or focus value) is changed using buttons or switches while Direct Menu is displayed, the Direct Menu may be canceled.

💡 Tips

- You can assign this function to an ASSIGN button (p. 85).
- You can also use the SEL/SET dial, instead of the multi-selector, to perform the operations above.

🔗 Notes

- Direct Menu is not available when using the following functions (including operation using operation buttons/ASSIGN buttons).
 - During menu display

Slow & Quick Motion/Super Slow Motion recording

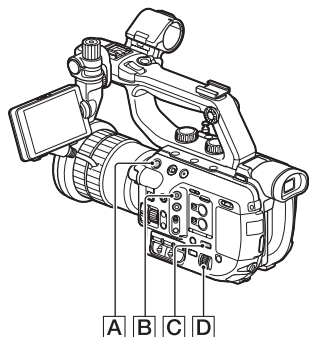

Slow & Quick Motion recording

By recording with a frame rate that is different from the playback frame rate, you can record smooth slow motion or quick motion images.

Notes

- The supported memory cards vary depending on the file format (p. 38).
- When recording with the Quick Motion recording function, your camcorder may continue recording for some time (approximately 30 seconds at most) after you press the record button to stop recording. Do not operate your camcorder while the [REC] indicator is flashing on the LCD screen; wait till it turns to [STBY].
- After you press the button to stop recording, your camcorder continues recording till it completes writing of the minimum unit of data (0.5 seconds of replay time).

1 Press the MENU button **C**.

2 Select **A** (CAMERA/PAINT) → [SLOW & QUICK] → [S&Q MOTION] → [REC FORMAT]/[FRAME RATE] with the SEL/SET dial **D**.

[REC FORMAT]: You can select the recording format from the following.

When [60i] is selected:

XAVC QFHD

2160/30p 100Mbps
2160/30p 60Mbps

XAVC HD

1080/60p 50Mbps
1080/60p 35Mbps
1080/30p 50Mbps
1080/30p 35Mbps
1080/24p 50Mbps
1080/24p 35Mbps

AVCHD

1080/60p PS, 1080/30p FX,
1080/30p FH, 1080/24p FX,
1080/24p FH

When [50i] is selected:

XAVC QFHD

2160/25p 100Mbps
2160/25p 60Mbps

XAVC HD

1080/50p 50Mbps
1080/50p 35Mbps
1080/25p 50Mbps
1080/25p 35Mbps

Slow & Quick Motion/Super Slow Motion recording (continued)

AVCHD

1080/50p PS, 1080/25p FX,
1080/25p FH

[FRAME RATE]: You can select the recording frame rate from the following.

When [60i] is selected:

1fps, 2fps, 4fps, 8fps, 15fps, 30fps,
60fps*

When [50i] is selected:

1fps, 2fps, 3fps, 6fps, 12fps, 25fps,
50fps*

* 60fps and 50fps cannot be selected for QFHD.

- See page 64 for the relationship between [FRAME RATE] and [REC FORMAT].

3 Select [EXECUTE].

The Slow & Quick Motion recording screen appears.

4 Press the START/STOP button [A] to start recording.

To stop recording

Press the START/STOP button.

To change the frame rate setting

During standby, press and hold the S&Q button [B], then change the value with the SEL/SET dial [D].

To cancel the setting, press and hold the S&Q button again.

To cancel the setting

Press the S&Q button [B] or the MENU button [C] during standby.

Playback speed based on the setting between [FRAME RATE] and [REC FORMAT] during Slow & Quick Motion

The playback speeds based on the recording format and frame rate setting are as follows.

XAVC HD/AVCHD

When [60i] is selected

FRAME RATE	REC FORMAT		
	1080/24p	1080/30p	1080/60p
60	40% slow	50% slow	100% (standard)
30	80% slow	100% (standard)	200% quick
15	160% quick	200% quick	400% quick
8	300% quick	375% quick	750% quick
4	600% quick	750% quick	1500% quick
2	1200% quick	1500% quick	3000% quick
1	2400% quick	3000% quick	6000% quick

When [50i] is selected

FRAME RATE	REC FORMAT	
	1080/25p	1080/50p
50	50% slow	100% (standard)
25	100% (standard)	200% quick
12	208% quick	417% quick
6	417% quick	833% quick
3	833% quick	1667% quick
2	1250% quick	2500% quick
1	2500% quick	5000% quick

XAVC QFHD

When [60i] is selected

FRAME RATE	REC FORMAT	
	2160/24p	2160/30p
30	80% slow	100% (standard)
15	160% quick	200% quick
8	300% quick	375% quick
4	600% quick	750% quick
2	1200% quick	1500% quick
1	2400% quick	3000% quick

When [50i] is selected

FRAME RATE	REC FORMAT
	2160/25p
25	100% (standard)
12	208% quick
6	417% quick
3	833% quick
2	1250% quick
1	2500% quick

Notes

- The maximum continuous recording time is approximately 6 hours for XAVC and approximately 13 hours for AVCHD.
- The [FRAME RATE] setting cannot be changed while recording. To change the setting, first stop recording.
- The time code is recorded in [REC RUN] mode (p. 162).
- The Slow & Quick Motion is canceled automatically when the ON/STANDBY switch is set to STANDBY (⏻), but the [FRAME RATE] setting is retained.
- You cannot record sound.
- For details about other limitations, see "Function limitations when recording" (p. 180).

Tip

- You can assign this function to an ASSIGN button (p. 85).

Recording in Super Slow Motion

By recording with a frame rate much higher than the playback frame rate, you can record images to be played back as super slow motion images. Images recorded with the Super Slow Motion function will appear smoother than slow playback of images recorded at normal speed.

Notes

- The supported memory cards vary depending on the file format (p. 38).
- When recording with the Super Slow Motion recording function, your camcorder may continue recording for some time (approximately 6 minutes at most) after you press the record button to stop recording. Do not operate your camcorder while the [REC] indicator is flashing on the LCD screen, and wait till it turns to [STBY].
- After you press the button to stop recording, your camcorder continues recording till it completes writing of the minimum unit of data (0.5 seconds of replay time).
- Super Slow Motion recording is not supported in XAVC QFHD.
- The shutter value may not be displayed correctly when recording in Super Slow Motion if [SHUTTER DISPLAY] is set to [DEGREE] (p. 160).

1 Press the MENU button .

2 Select (CAMERA/PAINT) → [SLOW & QUICK] → [SUPER SLOW MOTION] → [FRAME RATE]/[REC FORMAT]/[REC TIMING] with the SEL/SET dial .

[FRAME RATE]: You can select the recording frame rate from the following.

When [60i] is selected:

120 fps, 240 fps, 480 fps, 960 fps

When [50i] is selected:

100 fps, 200 fps, 400 fps, 800 fps

Slow & Quick Motion/Super Slow Motion recording (continued)

[REC FORMAT]: You can select the recording format from the following.

When [60i] is selected:

XAVC HD

1080/60p 50Mbps
1080/60p 35Mbps
1080/30p 50Mbps
1080/30p 35Mbps
1080/24p 50Mbps
1080/24p 35Mbps

AVCHD

1080/60p PS, 1080/30p FX,
1080/30p FH, 1080/24p FX,
1080/24p FH

When [50i] is selected:

XAVC HD

1080/50p 50Mbps
1080/50p 35Mbps
1080/25p 50Mbps
1080/25p 35Mbps

AVCHD

1080/50p PS, 1080/25p FX,
1080/25p FH

[REC TIMING]: You can select the timing to start recording when pressing the record button.

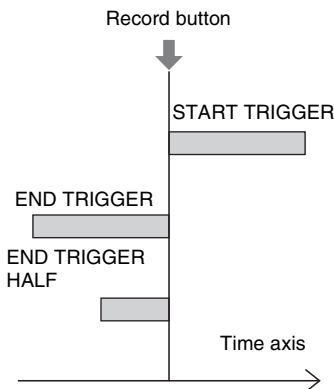

- See page 67 for the relationship between [FRAME RATE] and [REC FORMAT].
- See page 67 for variations in recording times based on [REC TIMING].

3 Select [EXECUTE].

The Super Slow Motion recording screen appears.

4 Press the START/STOP button [A] to start recording.

To decide the recording time manually

If [REC TIMING] is set to [START TRIGGER], you can stop recording at any time by pressing the START/STOP button.

To change the frame rate setting

During standby, press and hold the S&Q button [B], then change the value of the frame rate with the SEL/SET dial [D]. To cancel the setting, press and hold the S&Q button again.

If you missed a scene you wished to record

To stop recording, select [Cancel] on the recording screen. Recording stops, but the content recorded up to that point is saved. The file is displayed on the thumbnail screen.

To cancel the setting

Press the S&Q button [B] or the MENU button [C] during standby.

Playback speed based on the setting between [FRAME RATE] and [REC FORMAT] during Super Slow Motion

The playback speed based on the recording format and frame rate settings is as follows.

When [60i] is selected

FRAME RATE	REC FORMAT		
	1080/24p	1080/30p	1080/60p
960	2.5% slow	3.125% slow	6.25% slow
480	5% slow	6.25% slow	12.5% slow
240	10% slow	12.5% slow	25% slow
120	20% slow	25% slow	50% slow

When [50i] is selected

FRAME RATE	REC FORMAT	
	1080/25p	1080/50p
800	3.125% slow	6.25% slow
400	6.25% slow	12.5% slow
200	12.5% slow	25% slow
100	25% slow	50% slow

Recording time based on the setting between [REC TIMING] and [FRAME RATE]

The approximate recording time based on the recording timing and frame rate settings is as follows.

When [60i] is selected

FRAME RATE	REC TIMING		
	START TRIGGER	END TRIGGER	END TRIGGER HALF
960	19 sec	19 sec	9 sec
480	10 sec	10 sec	5 sec
240	8 sec	8 sec	4 sec
120	16 sec	16 sec	8 sec

When [50i] is selected

FRAME RATE	REC TIMING		
	START TRIGGER	END TRIGGER	END TRIGGER HALF
800	23 sec	23 sec	11 sec
400	12 sec	12 sec	6 sec
200	9 sec	9 sec	5 sec
100	19 sec	19 sec	10 sec

Notes

- Available only when full auto mode is off. Note that iris, gain and shutter speed are fixed to manual.
- When [960] ([800]) is selected in [FRAME RATE], the image to be displayed and recorded is approximately half the field angle.
- When [480], [960] ([400], [800]) is selected in [FRAME RATE], the image quality is deteriorated compared with the image with normal recording.
- If you adjust the gain or shutter speed, or change the white balance, the image on the LCD screen changes. However, the camera setting at the time the recording ends is reflected in the recorded image.
- To change the frame rate setting, first stop recording.
- The time code is recorded in [REC RUN] mode (p. 162).
- The Super Slow Motion is canceled automatically when the ON/STANDBY switch is set to STANDBY (⏻), but the [FRAME RATE] setting is retained.
- Flicker adjustment is not available.
- You cannot record sound.
- You cannot select a shutter speed value slower than the frame rate.
- You cannot use the WB SET button.
- Data code (time and camera data) is not recorded during AVCHD Super Slow Motion recording.
- For details about other limitations, see "Function limitations when recording" (p. 180).

Tip

- You can assign this function to an ASSIGN button (p. 85).

Slow-Motion recording at High Frame Rate (HFR)

Slow-motion recording at High Frame Rate (HFR) has been added to Slow & Quick Motion recording when the recording format is XAVC HD.

Unlike Super Slow Motion recording, video can be recorded up until the remaining capacity of the media runs out, in the same way as for normal recording. Consequently, slow-motion recording is now possible without missing shooting opportunities.

Shooting mode comparison

Shooting mode	Maximum recording time	Recording format	Maximum frame rate (XAVC HD, [60i])
Slow & Quick Motion recording	No limitations*	XAVC QFHD/ XAVC HD/ AVCHD	60fps
Super Slow Motion recording	Limitations apply	XAVC HD/ AVCHD	960fps
High Frame Rate recording	No limitations*	XAVC HD	120fps

* There is an upper limit on the maximum recording time, just as for normal recording. The maximum recording time will vary depending on the frame rate setting.

Preparing for High Frame Rate recording

* On the PXW-FS5, this function is supported using Ver. 4.0 or later. The CBKZ-FS5HFR option (sold separately) is required (see page 5).

There are two methods available for purchasing the option and installing it on the camcorder.

- After purchasing, obtain an installation key from the web site, and follow the on-

screen instructions on the camcorder. For details, follow the procedure in the Installation Guide of the CBKZ-FS5HFR.

- Connect a computer to the unit via USB to invoke the automatic detection function, and follow the instructions displayed on the computer (Ver. 4.0 and later).

* On the PXW-FS5M2/FS5M2K, purchase and installation of an option is not required.

Slow-motion recording at High Frame Rate

Playback speed

The playback speeds based on the recording format are as follows.

When [60i] is selected

FRAME RATE	1080/24p	1080/30p	1080/60p
120	20% slow	25% slow	50% slow

When [50i] is selected

FRAME RATE	1080/25p	1080/50p
100	25% slow	50% slow

Recording

- 1 Select  (CAMERA/PAINT) menu → [SLOW & QUICK] → [S&Q MOTION] → [HIGH FRAME RATE] → [ON].

- 2 Select [REC FORMAT].

3 Select a recording format.

(Default setting in bold)

60i	50i
1080/60p 50Mbps	1080/50p 50Mbps
1080/30p 25Mbps	1080/25p 25Mbps
1080/24p 25Mbps	–

The frame rate is fixed to the following value.

When [60i] is selected: 120

When [50i] is selected: 100

4 Select [EXECUTE] or press the S&Q (ASSIGN1) button.

5 Press the record button to begin recording.

To stop slow-motion recording

Press the record button.

To cancel slow-motion recording mode

Press the S&Q button or the MENU button during standby.

🔊 Notes

- The camcorder may continue recording for some time after you press the record button to stop recording.
- The time code is recorded in [REC RUN] mode.

💡 Tip

The High Frame Rate ON/OFF setting is not switched by the S&Q button. When Slow & Quick Motion is selected, the setting of the [HIGH FRAME RATE] menu item is always applied.

Limitations of High Frame Rate recording

The following functions cannot be used.

- FACE DETECTION
- COLOR BAR
- CENTER SCAN
- STREAMING
- DATE REC
- SIMULTANEOUS REC/RELAY REC
- PROXY REC MODE
- Wi-Fi remote control
- Full auto mode
- CLEAR IMAGE ZOOM
- AUTO BACK LIGHT
- Audio recording
- Shutter speed automatic adjustment
- RAW recording
- “ACTIVE” image stabilization (STEADYSHOT)

The following limitations also apply when recording at High Frame Rate.

- There are limitations on the shutter speed. Minimum value of 1/125 (when [60i] is selected), 1/100 (when [50i] is selected).
- The HDMI output is fixed to 60p or 60i (when [60i] is selected), or 50p or 50i (when [50i] is selected).

Recording in RAW format using a RAW recorder (sold separately)

Preparing to record in RAW mode

* On the PXW-FS5, this function is supported using Ver. 2.0 or later. An upgrade license for the option is required (see page 5).

Obtaining an install key

In order to use the RAW recording function on the PXW-FS5, it is necessary to purchase the “CBKZ-FS5RIF” (sold separately), obtain the install key via the Internet according to the following procedure, then install the option on the camcorder.

For details, follow the procedure in the Installation Guide of the “CBKZ-FS5RIF” (sold separately).

Purchase the “CBKZ-FS5RIF” (sold separately).



Obtain an install key.



Install the option on the camcorder.



Record in RAW mode.

* On the PXW-FS5M2/FS5M2K, purchase and installation of an option is not required.

Connecting devices for recording

Signals output from the SDI OUT jack of this camcorder can be converted by the HXR-IFR5 (sold separately), and recorded as RAW images on the AXS-R5 (sold separately).

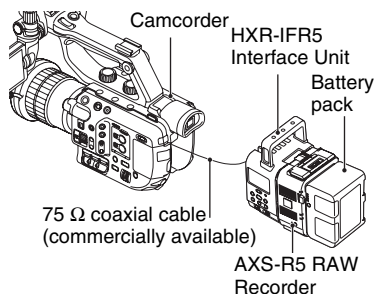

- The software version of the AXS-R5 must be Ver. 1.20 or later.

When shooting RAW images, the following settings on the camera are recommended.

- White balance: 3200K, 4300K, or 5500K
- ISO sensitivity/gain: Minimum ISO sensitivity/0 dB

Notes when shooting RAW images





- You can trigger an external recorder to start/stop recording by pressing the START/STOP button on the camcorder. However, the status of the external recorder cannot be checked on the LCD screen.
- Triggering an external recorder is always enabled when recording in RAW. The recording trigger status is displayed on the LCD screen of the camcorder. For details, see the icon description (p. 71).
- The recording date, time, and color bars cannot be recorded when recording in RAW.
- Flicker adjustment is disabled.
- Images are recorded in 17:9 in RAW, but are displayed on the LCD screen of the camcorder in 16:9 (Edge Crop).
- When recording in RAW, SDI output settings are disabled.
- RAW images recorded on an external recorder cannot be played back on this camcorder. To view recorded RAW

images, connect the AXS-R5 to a monitor, and then play back the images.

- Changing the gamma curve may change the dynamic range of the image recorded (output), depending on the type of gamma curve.
- Noise may appear in an image, depending on the combination of gamma and recording mode.
- The [REC BUTTON SETTING] status check is not displayed when shooting RAW output only.
- When shooting in Super Slow Motion, the final few frames of images being recorded are the same image. In some cases, a noise image may be included.
- Lens compensation is not performed for video recorded in RAW format.
- Setting the lens compensation setting (CAMERA/PAINT → LENS COMPENSATION in the menu) to OFF allows you to check video equivalent to RAW video.

Selecting RAW output and unit recording format



Setting the file format to RAW

Select  (REC/OUT SET) → [REC SET] → [FILE FORMAT] → [] & XAVC HD) or [] in the menu. The  icon appears on the screen.

Note

- RAW images and XAVC HD movies recorded with the [] & XAVC HD) setting may begin and finish at different times.

Setting the RAW output format

Select  (REC/OUT SET) → [REC SET] → [] OUTPUT FORMAT] and select the desired format.

Settings (default setting in bold)	
[60i]	[50i]
4096×2160/60p	4096×2160/50p
4096×2160/30p	4096×2160/25p
4096×2160/24p	

Camera recording formats for RAW output

The camera recording format for the format selected using [] OUTPUT FORMAT] is shown below.

When [60i] is selected:

[] OUTPUT FORMAT] setting	Camera recording format (XAVC HD)
[4096×2160/60p]	1080/60p 50Mbps
[4096×2160/30p]	1080/30p 50Mbps
[4096×2160/24p]	1080/24p 50Mbps

The bit rate is fixed to 50 Mbps.

When [50i] is selected:

[] OUTPUT FORMAT] setting	Camera recording format (XAVC HD)
[4096×2160/50p]	1080/50p 50Mbps
[4096×2160/25p]	1080/25p 50Mbps

The bit rate is fixed to 50 Mbps.

Signal output from output jacks

During RAW output, the RAW signal is always output on the SDI OUT jack, regardless of the SDI OUT output format setting ( (REC/OUT SET) → [VIDEO OUT]).

The output is the same for the HDMI and VIDEO settings when RAW is disabled. However, if [SDI/HDMI] is set to 2160p/1080p/480i or 1080p/480i when shooting with 4K SUPER SLOW or 2K SUPER SLOW in [60i] mode, the HDMI output is set to 1080/60p for both recording and playback.

 SDI : Ready to send a trigger to start recording on an external recorder.

 REC : A trigger to start recording has been sent to an external recorder.

Recording in RAW format using a RAW recorder (sold separately) (continued)



No icon: A trigger to start recording cannot be sent to an external recorder.

Note

- Even when  is displayed on the screen, recording to an external recorder may not be carried out correctly, depending on the external recorder's status (e.g. insufficient free space on recording media, low battery charge, incorrect connection to camcorder). When recording on an external recorder, check that recording is being carried out correctly.

RAW 4K Super Slow Motion



4K super slow motion images can be captured. The capture time is approximately four seconds.

Select  (CAMERA/PAINT) → [SLOW & QUICK] → [] 4K SUPER SLOW] in the menu and set the following items.

Item	Settings (default setting in bold)
[] OUTPUT FORMAT]	[60i]: 4096×2160/60p 4096×2160/30p 4096×2160/24p [50i]: 4096×2160/50p 4096×2160/25p
[FRAME RATE]	Fixed to the following. [60i]: 120fps [50i]: 100fps
[REC TIMING]	START TRIGGER END TRIGGER END TRIGGER HALF



RAW 2K Super Slow Motion

2K super slow motion images can be captured.



Select  (CAMERA/PAINT) → [SLOW & QUICK] → [] 2K SUPER SLOW] in the menu and set the following items.



Item	Settings (default setting in bold)
[] OUTPUT FORMAT]	[60i]: 2048×1080/60p 2048×1080/30p 2048×1080/24p [50i]: 2048×1080/50p 2048×1080/25p
[FRAME RATE]	[60i]: 240fps, 120fps [50i]: 200fps, 100fps

Setting the S&Q button for RAW

You can set the function to assign to the S&Q button when recording in RAW mode. Select  (SYSTEM) → [] S&Q BUTTON SET] in the menu and select a function.

Settings (default setting in bold)

[] **4K/2K SUPER SLOW**]*,
[] 4K SUPER SLOW],
[] 2K SUPER SLOW]

- * When [] 4K/2K SUPER SLOW] is selected, the function switches to [] 4K SUPER SLOW] → [] 2K SUPER SLOW] → OFF in sequence each time you press the S&Q button.

Tip

- Available only when full auto mode is off. Note that exposure correction is set to manual.

MPEG HD recording

* An upgrade license for the option is required for this function (see page 5). On the PXW-FS5, this function is supported using Ver. 3.0 or later (see page 5).

Preparing to record in MPEG HD

In order to use the MPEG HD recording function, it is necessary to purchase the “CBKZ-SLMP” (sold separately), obtain the install key via the Internet according to the following procedure, and then install the option on the camcorder.

For details, follow the procedure in the Installation Guide of the “CBKZ-SLMP” (sold separately).

Purchase the MPEG HD Upgrade License “CBKZ-SLMP” (sold separately)



Obtain an install key.



Install the option on the camcorder.



Record movies in MPEG HD.

Recording in MPEG HD

When compatible recording media* is inserted in the camcorder, you can switch to MPEG HD recording in the menu.

* See “Recommended memory cards” (p. 78).

1 Select **⇄** (REC/OUT SET) menu → [REC SET] → [FILE FORMAT] → [MPEG HD 422] or [MPEG HD 420].

2 Select **⇄** (REC/OUT SET) menu → [REC SET] → [REC FORMAT].

3 Select the recording format.

MPEG HD 422

(Default setting in bold)

60i	50i
1080/60i 50Mbps	1080/50i 50Mbps
1080/30p 50Mbps	1080/25p 50Mbps
1080/24p 50Mbps	–
720/60p 50Mbps	720/50p 50Mbps

MPEG HD 420

(Default setting in bold)

60i	50i
1080/60i HQ	1080/50i HQ
1080/30p HQ	1080/25p HQ
1080/24p HQ	–
1080/60i (1440) HQ	1080/50i (1440) HQ
720/60p HQ	720/50p HQ

4 Press the record button to begin recording.

Notes

- The following limitations apply when recording in MPEG HD.
 - GPS (position information) is not supported.
 - Data code recording and display is not supported. If data code display is set to ON during playback, “-” is displayed.
 - Color bars can be used only when proxy recording is OFF.
 - Date recording can be used only during interlaced recording.
- When recording in MPEG HD, recording stops automatically when the recorded file reaches 6 hours duration.
- The maximum recording time in MPEG HD using relay recording is 6 hours. Recording

MPEG HD recording (continued)

stops automatically when the maximum recording time elapses.

- The camcorder can no longer record when the maximum number of XAVC/MPEG HD files is reached (600).
- MPEG HD movies are stored in the [PRIVATE] → [XDROOT] folder on memory cards.

About proxy recording

Proxy recording is supported in MPEG HD mode.

For details about the size of recorded proxy files, see “Proxy recording supported formats” (p. 79).

Slow & Quick Motion Recording

1 Select  (CAMERA/PAINT) menu → [SLOW & QUICK] → [S&Q MOTION] → [REC FORMAT].

2 Select the recording format.

MPEG HD 422

(Default setting in bold)

60i	50i
1080/30p 50Mbps	1080/25p 50Mbps
1080/24p 50Mbps	–

MPEG HD 420

(Default setting in bold)

60i	50i
1080/30p HQ	1080/25p HQ
1080/24p HQ	–

3 Select  (CAMERA/PAINT) menu → [SLOW & QUICK] → [S&Q MOTION] → [FRAME RATE], and set the frame rate.

(Default setting in bold)

60i	50i
30fps	25fps
15fps	12fps
8fps	6fps
4fps	3fps
2fps	2fps
1fps	1fps

4 Select [EXECUTE].

5 Press the record button to begin recording.

Playback speed for [FRAME RATE] and [REC FORMAT] settings during Slow & Quick Motion

When [60i] is selected

FRAME RATE	REC FORMAT	
	1080/24p	1080/30p
30	80% slow	100% (standard)
15	160% quick	200% quick
8	300% quick	375% quick
4	600% quick	750% quick
2	1200% quick	1500% quick
1	2400% quick	3000% quick

When [50i] is selected

FRAME RATE	REC FORMAT
	1080/25p
25	100% (standard)
12	208% quick
6	417% quick
3	833% quick
2	1250% quick

FRAME RATE	REC FORMAT
	1080/25p
1	2500% quick

Note

The same limitations and precautions for XAVC HD also apply for Slow & Quick Motion. See page 63.

Super Slow Motion Recording

1 Select (CAMERA/PAINT) menu → [SLOW & QUICK] → [SUPER SLOW MOTION] → [REC FORMAT].

2 Select the recording format.

MPEG HD 422

(Default setting in bold)

60i	50i
1080/30p 50Mbps	1080/25p 50Mbps
1080/24p 50Mbps	–

MPEG HD 420

(Default setting in bold)

60i	50i
1080/30p HQ	1080/25p HQ
1080/24p HQ	–

3 Select (CAMERA/PAINT) menu → [SLOW & QUICK] → [SUPER SLOW MOTION] → [FRAME RATE], and set the frame rate.

(Default setting in bold)

60i	50i
960fps	800fps
480fps	400fps
240fps	200fps

60i	50i
120fps	100fps

4 Select (CAMERA/PAINT) menu → [SLOW & QUICK] → [SUPER SLOW MOTION] → [REC TIMING], and select the timing for recording.

REC TIMING settings
(Default setting in bold)

START TRIGGER, END TRIGGER,
END TRIGGER HALF
(See diagram below for timing)

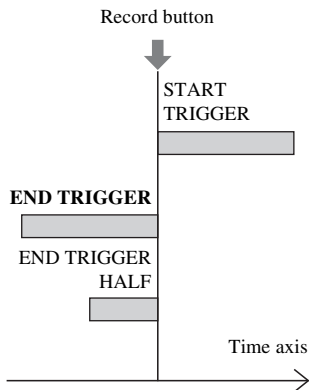

For the recording time settings, see “Recording time for [REC TIMING] and [FRAME RATE] settings” (p. 76).

5 Select [EXECUTE].

6 Press the record button to begin recording.

MPEG HD recording (continued)

Note

The recording time from when recording starts until recording ends is approximately double the XAVC recording time.

Playback speed for [FRAME RATE] and [REC FORMAT] settings during Super Slow Motion

When [60i] is selected

FRAME RATE	REC FORMAT	
	1080/24p	1080/30p
960	2.5% slow	3.125% slow
480	5% slow	6.25% slow
240	10% slow	12.5% slow
120	20% slow	25% slow

When [50i] is selected

FRAME RATE	REC FORMAT
	1080/25p
800	3.125% slow
400	6.25% slow
200	12.5% slow
100	25% slow

Recording time for [REC TIMING] and [FRAME RATE] settings

The approximate recording time based on the recording timing and frame rate settings is as follows.

When [60i] is selected

FRAME RATE	REC TIMING		
	START TRIGGER	END TRIGGER	END TRIGGER HALF
960	19 sec	19 sec	9 sec
480	10 sec	10 sec	5 sec
240	8 sec	8 sec	4 sec
120	16 sec	16 sec	8 sec

When [50i] is selected

FRAME RATE	REC TIMING		
	START TRIGGER	END TRIGGER	END TRIGGER HALF
800	23 sec	23 sec	11 sec
400	12 sec	12 sec	6 sec
200	9 sec	9 sec	5 sec
100	19 sec	19 sec	10 sec

Note

The same limitations and precautions for XAVC HD also apply for Super Slow Motion. See page 65.

Playback in MPEG HD

Movies recorded in MPEG HD can be played back in MPEG HD.

- 1 Press the **THUMBNAIL** button.
- 2 You can switch playback mode to **[MPEG HD 422]** or **[MPEG HD 420]** on the thumbnail screen.

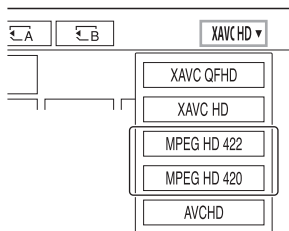

- 3 Select the thumbnail of the movie you want to play to start playback.

MPEG HD output formats

The output signal formats for MPEG HD are the same as for XAVC HD. See page 125.

MPEG HD recording (continued)

Recommended memory cards

File format	Supported memory cards
MPEG HD 422/420	SDXC memory cards (Class 10 or U1 or faster)
MPEG HD 422/420 (Slow & Quick Motion, Super Slow Motion)	SDXC memory cards (U3)
MPEG HD 422/420 (Proxy simultaneous recording)	SDXC memory cards (Class 10 or U1 or faster) SDXC memory cards (U3) are required for MPEG HD 422/ proxy (9 Mbps) simultaneous recording.

Estimated recording time of movies

Unit: minutes

MPEG HD 422	1080	720
	50Mbps	50Mbps
64GB	110 (110)	110 (110)

MPEG HD 422 + PROXY (9M)	1080	720
	50Mbps	50Mbps
64GB	95 (95)	95 (95)

MPEG HD 422 + PROXY (3M)	1080	720
	50Mbps	50Mbps
64GB	105 (105)	100 (100)

MPEG HD 420	1080	1080 (1440)	720
	HQ (max. 35 Mbps)	HQ (max. 35 Mbps)	HQ (max. 35 Mbps)
64GB	175 (175)	175 (175)	170 (170)

MPEG HD 420 + PROXY (9M)	1080	1080 (1440)	720
	HQ (max. 35 Mbps)	HQ (max. 35 Mbps)	HQ (max. 35 Mbps)
64GB	140 (140)	140 (140)	135 (135)

MPEG HD 420 + PROXY (3M)	1080	1080 (1440)	720
	HQ (max. 35 Mbps)	HQ (max. 35 Mbps)	HQ (max. 35 Mbps)
64GB	160 (160)	160 (160)	155 (155)

- When using Sony memory cards.
- The number in () is the minimum recordable time.

Tips

- The maximum number of scenes that can be recorded is 600 in XAVC and MPEG HD.
- The continuous recording time using relay recording is 6 hours for MPEG HD422/MPEG HD420.
- If the file format uses VBR (Variable Bit Rate) to automatically adjust the bit rate (varies the data recorded per second) to suit the recording scene, the recording time of the memory card will also vary. For example, movies containing quickly moving and complex images are recorded at a higher bit-rate, and this reduces the overall recording time of the memory card.
- Bit-rate (movie + audio, etc.) and number of pixels of each file format are as follows.
 - MPEG HD 422
50Mbps, 1920×1080
50Mbps, 1280×720
 - MPEG HD 420
HQ: 35Mbps (max) 1920×1080
HQ: 35Mbps (max) 1440×1080
HQ: 35Mbps (max) 1280×720

Proxy recording supported formats

MPEG HD 422

Original file		Proxy file					
Image size		1280×720			640×360		
	Frame rate (fps)	60(50)p	30(25)p	24p	60(50)p	30(25)p	24p
	Bit rate (Mbps)	9	9	9	3	3	3
1920×1080	60(50)i	50	Yes			Yes	
	30(25)p	50	Yes			Yes	
	24p	50		Yes			Yes
1280×720	60(50)p	50	Yes		Yes		

MPEG HD recording (continued)

MPEG HD 420

Original file			Proxy file					
Image size			1280×720			640×360		
	Frame rate (fps)		60(50)p	30(25)p	24p	60(50)p	30(25)p	24p
	Bit rate (Mbps)		9	9	9	3	3	3
1920×1080	60(50)i	HQ	Yes			Yes		
	30(25)p	HQ	Yes			Yes		
	24p	HQ				Yes		Yes
1440×1080	60(50)i	HQ	Yes			Yes		
1280×720	60(50)p	HQ	Yes				Yes	

Streaming supported formats

Original file (MPEG HD 422)			Streaming data				
Image size			1280×720			640×360	
	Frame rate (fps)		30(25)p	24p	60(50)p	30(25)p	24p
	Bit rate (Mbps)		3	3	2	1	1
1920×1080	60(50)i	50	Yes			Yes	
	30(25)p	50	Yes			Yes	
	24p	50	Yes				Yes
1280×720	60(50)p	50				Yes	

Original file (MPEG HD 420)			Streaming data				
Image size			1280×720			640×360	
	Frame rate (fps)		30(25)p	24p	60(50)p	30(25)p	24p
	Bit rate (Mbps)		3	3	2	1	1
1920×1080	60(50)i	HQ	Yes			Yes	
	30(25)p	HQ	Yes			Yes	
	24p	HQ	Yes				Yes
1440×1080	60(50)i	HQ	Yes			Yes	
1280×720	60(50)p	HQ				Yes	

About the MPEG format

Recording and playback on your camcorder

Your camcorder can record in HD, based on the MPEG format.

This uses a Long-GOP video compression format for recording.

Video*: MPEG-2 MP@HL

When [60i] is selected:

1920×1080/60i, 1920×1080/30p,
1920×1080/24p, 1440×1080/60i,
1280×720/60p

When [50i] is selected:

1920×1080/50i, 1920×1080/25p,
1440×1080/50i, 1280×720/50p

Video*: MPEG-2 422P@HL

When [60i] is selected:

1920×1080/60i, 1920×1080/30p,
1920×1080/24p, 1280×720/60p

When [50i] is selected:

1920×1080/50i, 1920×1080/25p,
1280×720/50p

Audio: LPCM 2ch

Recording media: Memory card

* The camcorder is not able to play back data that is recorded in MPEG format using settings other than those described above.

Audio
recording
format

MPEG HD422: Linear PCM
2ch, 24-bit, 48 kHz

MPEG HD420: Linear PCM
2ch, 16-bit, 48 kHz

MPEG HD Proxy: AAC-LC
2ch, 16-bit, 48 kHz

Specifications

System

Video recording format	MPEG HD422: MPEG-2 422P@HL 4:2:2 Long profile
	MPEG HD420: MPEG-2 MP@HL 4:2:0 Long profile
	MPEG HD Proxy: MPEG-4 AVC/H.264 4:2:0 Long profile

Audio setup

The following jacks, switches and dials allow you to set the sound to be recorded. See page 28 for details about connecting a microphone.

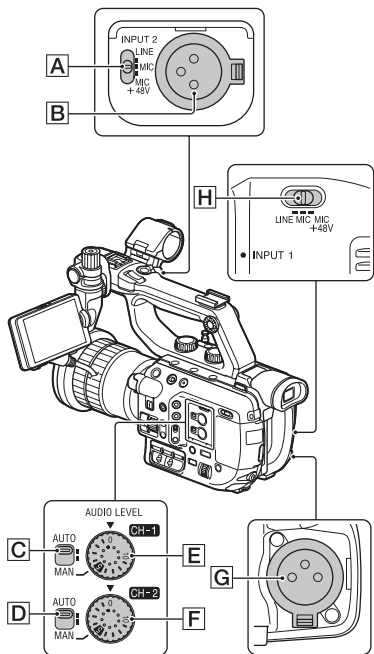

External audio input jacks and switches

- A** INPUT 2 switch
- B** INPUT 2 jack
- G** INPUT 1 jack
- H** INPUT 1 switch

Audio level controls

- C** AUTO/MAN (CH-1) switch
- D** AUTO/MAN (CH-2) switch
- E** AUDIO LEVEL (CH-1) dial
- F** AUDIO LEVEL (CH-2) dial

Recording sound from the internal microphone

You can record sound in stereo using the camcorder's internal microphone.

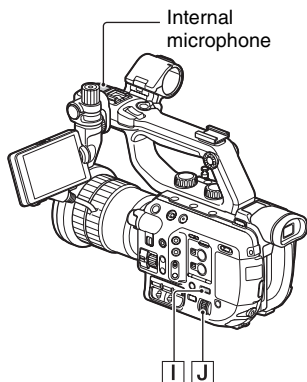

- 1** Press the MENU button **I**.
- 2** Select (AUDIO SET) → [CH1 INPUT SELECT] → [INT MIC] with the SEL/SET dial **J**.
- 3** Select (AUDIO SET) → [CH2 INPUT SELECT] → [INT MIC] with the SEL/SET dial **J**.

Recording sound from an external audio device

To use an external audio device, or a microphone other than the internal microphone, change the following settings.

1 Select the input source.

Set the INPUT 1 switch **[H]** and INPUT 2 switch **[A]** according to the devices connected to the INPUT 1 jack **[G]** and INPUT 2 jack **[B]**, respectively.

Audio devices	Switch position
External audio device (mixer, etc.)	LINE
Dynamic microphones or microphones with a built-in battery	MIC
+48V powered (phantom power) microphone	MIC+48V

- If you connect a device that does not support +48V phantom power, a malfunction may result from setting this switch to MIC+48V. Check before connecting the device.
- When there is no audio device connected to an INPUT jack, set the INPUT switch of that jack to LINE to prevent noise.

2 Set the input level of the microphone.

- Set the input level of an XLR microphone in [INPUT1 TRIM]/[INPUT2 TRIM] in the menu (p. 157). Adjust the level according to the sensitivity of the microphone.
- You can set an input level between -60 dBu (+12 dB) and -30 dBu (-18 dB) in 6 dB increments. The default setting is -48 dBu (0 dB).

3 Select the input source for each channel.

- ① Press the MENU button **[I]**.
- ② Select **[J]** (AUDIO SET) → [CH1 INPUT SELECT] → [INPUT1] with the SEL/SET dial **[J]**.
- ③ Select **[J]** (AUDIO SET) → [CH2 INPUT SELECT] → [INPUT2] with the SEL/SET dial **[J]**.

Tip

- When using a stereo microphone that has two XLR plugs, connect the left channel (L) to the INPUT 1 jack, and the right channel (R) to the INPUT 2 jack. Set CH-1 to INPUT 1, and CH-2 to INPUT 2.

Recording with a Multi-Interface Shoe-compatible microphone (sold separately)

You can record audio with a Multi-Interface Shoe-compatible microphone.

1 Connect a compatible microphone (sold separately) to the Multi-Interface Shoe.

2 Select the microphone using the menu.

- ① Press the MENU button.
- ② **To set CH-1:**
Select **[J]** (AUDIO SET) → [CH1 INPUT SELECT] → [MI SHOE MIC] with the SEL/SET dial.
To set CH-2:
Select **[J]** (AUDIO SET) → [CH2 INPUT SELECT] → [MI SHOE MIC] with the SEL/SET dial.



Audio setup (continued)

To set both CH-1 and CH-2:

Perform both operations above.

Adjusting the audio recording level

When both CH-1 and CH-2 are set to “INT MIC,” both the left and right channels are adjusted by the CH-1 switch **[C]** and dial **[E]**.

- 1 Press the MENU button.**
- 2 Select  (AUDIO SET) → [CH1 INPUT SELECT] or [CH2 INPUT SELECT] with the SEL/SET dial.**
- 3 Set the AUTO/MAN switch (**[C]** and **[D]**) of the channels to adjust to “MAN.”**
M₁ appears on the LCD screen.
- 4 During recording or standby, turn the AUDIO LEVEL dial (**[E]** and **[F]**) of the channels to adjust.**

To restore automatic adjustment

Set the AUTO/MAN switch (**[C]** and **[D]**) of the manually adjusted channels to “AUTO.”

Setting the Headphone Output

* On the PXW-FS5, this function is supported using Ver. 2.0 or later (see page 5).

Setting the headphone audio

Select  (AUDIO SET) → [HEADPHONE OUT] in the menu, and select the audio for output.

Settings (default setting in bold)	Output audio	
	Left (L)	Right (R)
STEREO	CH-1	CH-2
MIX MONO	CH-1+CH-2	CH-1+CH-2
CH1	CH-1	CH-1
CH2	CH-2	CH-2

Assigning functions to the ASSIGN buttons/dial

Some functions can be assigned to the ASSIGN buttons or the ASSIGN dial. You can assign a single function to each of the ASSIGN1 to 6 buttons and ASSIGN dial.

See the referenced page numbers for details about each function.

Default function of each ASSIGN button

- ASSIGN1: S&Q MOTION (p. 63)
- ASSIGN2: PICTURE PROFILE (p. 103)
- ASSIGN3: STATUS CHECK (p. 123)
- ASSIGN4: FOCUS MAGNIFIER (p. 46)
- ASSIGN5: DIRECT (p. 61)
- ASSIGN6: (No assignment)

Functions you can assign to the ASSIGN buttons

- – (no function)
- FOCUS MAGNIFIER (p. 46)
- LAST SCENE REVIEW (p. 113)
- WB PRESET (p. 55)
- AE SHIFT (p. 149)
- CENTER SCAN (p. 150)
- STEADYSHOT (p. 151)
- S&Q MOTION (p. 63)
- IRIS PUSH AUTO (p. 50)
- FACE DETECTION (p. 47)
- COLOR BAR (p. 152)
- DIRECT (p. 61)
- MENU (p. 139)
- PICTURE PROFILE (p. 103)
- VOLUME (p. 155)
- HISTOGRAM (p. 158)
- ZEBRA (p. 54)
- PEAKING (p. 158)
- MARKER (p. 158)
- CAMERA DATA DISPLAY (p. 159)
- AUDIO LEVEL DISPLAY (p. 160)
- DATA CODE (p. 122, 161)
- GAMMA DISP ASSIST (p. 111)
- TC/UB DISPLAY (p. 162)

- DISPLAY (p. 122, 134, 135)
- SMARTPHONE CONNECT (p. 88)
- STREAMING (p. 97)
- STREAM OPERATION (p. 98)
- FTP TRANSFER (p. 99)
- STATUS CHECK (p. 123)
- REC LAMP[F] (p. 166)
- REC LAMP[R] (p. 166)
- THUMBNAIL (p. 119)
- AUTO ND FILTER (p. 54)

Default function of the ASSIGN dial

- IRIS (p. 50)

Functions you can assign to the ASSIGN dial

- – (no function)
- IRIS (p. 50)
- ND FILTER (p. 53)
- ISO/GAIN (p. 51)
- AE SHIFT (p. 149)
- FOCUS (p. 44)

Assigning functions to the ASSIGN buttons/dial (continued)

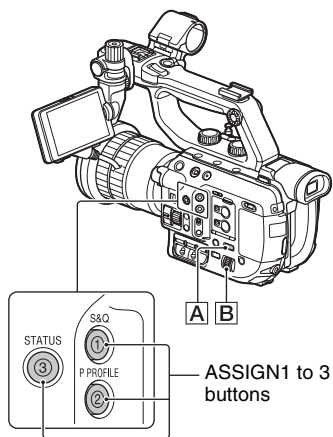

ASSIGN dial

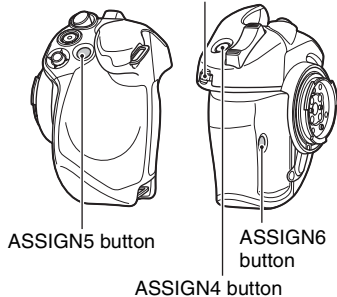

ASSIGN5 button

ASSIGN6 button

ASSIGN4 button

-
- 3** Select the ASSIGN button to which you want to assign a function with the SEL/SET dial **[B]**, then press the dial.

[-----] appears if no function is assigned to the ASSIGN button.

-
- 4** Select the function that you want to assign with the SEL/SET dial **[B]**, then press the dial.

-
- 5** Select [OK] with the SEL/SET dial **[B]**, then press the dial.

Assigning a function to the ASSIGN dial

- 1 Press the MENU button **[A]**.
- 2 Select **[SYSTEM]** → [ASSIGN DIAL] with the SEL/SET dial **[B]**.
- 3 Select the function that you want to assign with the SEL/SET dial **[B]**, then press the dial.

-
- 1** Press the MENU button **[A]**.

-
- 2** Select **[SYSTEM]** → [ASSIGN DIAL] with the SEL/SET dial **[B]**.

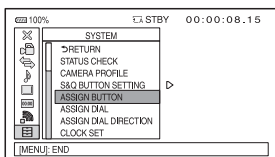

Using the Wi-Fi function

What you can do with the Wi-Fi function of the camcorder

The Wi-Fi function of the camcorder enables you to operate the camcorder remotely using a smartphone.

Using a smartphone as a camera remote control (One-touch remote (NFC))

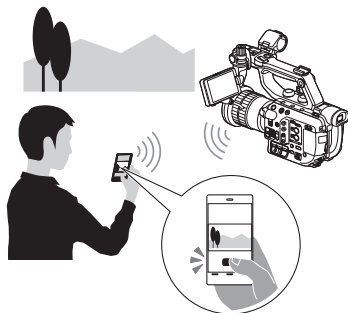

Required equipment/environment

Smartphone or tablet computer

Downloading “Content Browser Mobile”

To use a smartphone as a remote control for the camcorder, you need to install the dedicated “Content Browser Mobile” application on your smartphone. If “Content Browser Mobile” is already installed on your smartphone, update it to the latest version as necessary.

Android OS

Search for “Content Browser Mobile” in Google Play, then install it.



- You need Android 4.1 or later when you use NFC One-touch.
- Google play may not be supported depending on country or region. In this case, search for “Content Browser Mobile” on the Internet then install it.

iOS

Search for “Content Browser Mobile” in the App Store, then install it.



You need iOS 7.0 or later.

- You cannot use NFC One-touch when you use iOS.

Notes

- You need an NFC-compatible smartphone or tablet computer in order to use the NFC One-touch function of the camcorder.
- Proper operation of the Wi-Fi function detailed in this manual is not guaranteed for all smartphones or tablet computers.

Using the Wi-Fi function (continued)

- Operations and screen displays of the application may be subject to change without notice by future upgrades.

Connecting the camcorder to an Android smartphone equipped with the NFC function using One-touch connection

- 1** Select [Settings] on the smartphone, then select [More...] and place a check mark next to [NFC].

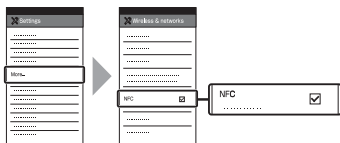

- 2** Set the camcorder to shooting mode.

You can use the NFC function only when  (N-Mark) is displayed on the screen.

- 3** Touch the smartphone against the camcorder.

The smartphone connects to the camcorder, and launches “Content Browser Mobile.”

[CTRL W/SMARTPHONE] starts on the camcorder.

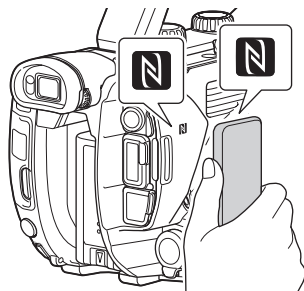

Tips

- Cancel sleep mode and screen lock of the smartphone beforehand.
- Continue to touch (1 to 2 seconds) the smartphone against the camcorder, without moving it, until “Content Browser Mobile” starts.
- While [CTRL W/SMARTPHONE] is activated, only the START/STOP button and handle record button are available on the camcorder.
- The smartphone cannot be connected to the camcorder when [AIRPLANE MODE] is set to [ON]. Set [AIRPLANE MODE] to [OFF] (p. 163).

Using a smartphone as a camcorder remote control

You can control some of the camcorder’s shooting functions remotely with a smartphone. To start [CTRL W/SMARTPHONE] using the NFC function, see page 88.

- 1** Press the MENU button.

- 2** Select  (NETWORK SET) → [CTRL W/SMARTPHONE] with the SEL/SET dial.

3 Connect the smartphone to the camcorder, using the information that appears on the screen when the camcorder is ready to be connected.

The connection method will depend on the type of smartphone.

Android: page 89

iPhone/iPad: page 90

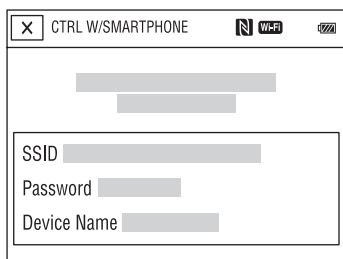

4 Operate the camcorder using the smartphone.

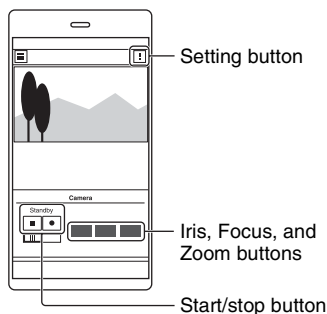

Notes

- Live view images may not be displayed smoothly, depending on the smartphone performance and/or transmission conditions.

- Movies cannot be saved on a smartphone.
- For details about usage restrictions, see “Function limitations when recording” (p. 180).

Tip

- You can assign [SMARTPHONE CONNECT] to an ASSIGN button.
You can start [CTRL W/SMARTPHONE] by pressing that ASSIGN button when the shooting screen is displayed (p. 85).

Functions that can be controlled using [CTRL W/SMARTPHONE]

- Recording start/stop
- Touch focus
 - Available when using manual focus.
- Zooming
- Iris adjustment

Note

- You cannot perform other operations during touch focus.

Connecting without using the NFC function (Android)

- 1 Select [Settings] on your smartphone, then select [Wi-Fi] and the SSID (displayed on the camcorder).

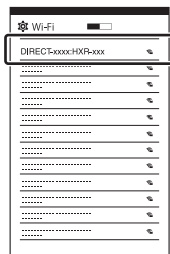

- 2 Input the password displayed on the camcorder (first time only).

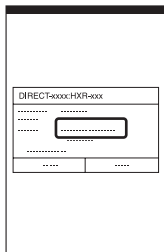

- 3 Confirm connection to the SSID displayed on the camcorder.

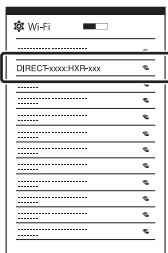

Tip

- The next time that you want to connect to the camcorder, select the camcorder in the device list in the Connect menu, and select [Connect].

- 4 Return to the Home screen, then start “Content Browser Mobile.”

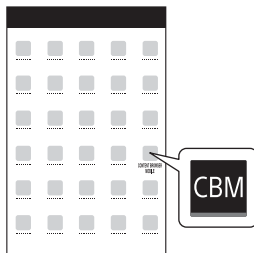

For details on how to operate “Content Browser Mobile” after it starts, refer to the Help section in “Content Browser Mobile.”

Connecting without using the NFC function (iPhone/iPad)

- 1 Select [Settings] on the iPhone or iPad, then select [Wi-Fi] and the SSID (displayed on the camcorder).

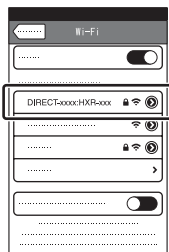

-
- 2** Input the password displayed on the camcorder (first time only).

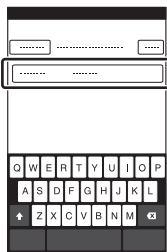

For details on how to operate “Content Browser Mobile” after it starts, refer to the Help section in “Content Browser Mobile.”

-
- 3** Confirm connection to the SSID displayed on the camcorder.

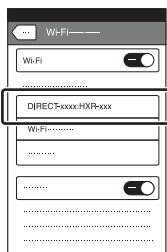

-
- 4** Return to the Home screen, then start “Content Browser Mobile.”

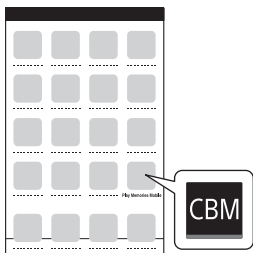

Using network functions

When the camcorder is connected to a network, you can stream a movie in real-time or transfer recorded files to an FTP server.

Configuring a wireless LAN

You can connect the camcorder to a network using a wireless LAN.

Selecting and registering an access point

You can connect the camcorder and an access point using a wireless LAN.

1 Press the MENU button.

2 Select (NETWORK SET) → [Wi-Fi SET] → [ACCESS POINT SET] with the SEL/SET dial.

After a short delay, a list of access points that can be connected is displayed.

3 Select an access point to register.

If an access point you want to register is not displayed, select [Manual setting] and configure settings manually (p. 94).

4 Enter the password, and select [Next].

Password entry is not required for access points that do not display .

5 Configure the access point settings.

IP address

Select the IP address configuration method.

When [Manual] is selected, enter the IP address configuration items displayed on the screen, and select [OK].

Priority Connection

Select whether to configure connection priority for access points.

Tip

- Selecting [DNS server setting] on the IP ADDRESS SET screen will display the DNS server setting screen.

6 Select [Register].

- Connection to the access point is initiated.
- [Registered.] appears when the access point is registered successfully. The SSID of the registered access point is also displayed.

7 Select [OK] → [X], and press the MENU button to close the menu screen.

Registering an access point using the WPS function

You can register an access point quickly if the access point supports the WPS function.

1 Turn on the access point.

2 Turn on the camcorder.

3 Press the MENU button.

4 Select (NETWORK SET) → [Wi-Fi SET] → [WPS] with the SEL/SET dial.

- After a short delay, the following screen appears.

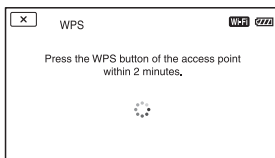

5 Press the WPS button of the access point within the next two minutes.

- For details about the WPS button function, refer to the manual for the access point.
- Connection to the access point is initiated.
- [Registered.] appears when the access point is registered successfully. The SSID of the registered access point is also displayed.
- A message is displayed on the screen if the access point could not be connected. Select [OK], then repeat the procedure after selecting [WPS] in step 4.

6 Select [OK] → [X], and press the MENU button to close the menu screen.

Notes

- For details about the functions and settings supported by your access point, refer to the manual for the access point or contact the access point administrator.
- The camcorder and access point may not connect or the distance between them for successful communication may be short, depending on the surrounding environment, such as obstacles and walls, and the radio wave conditions. Move the camcorder or otherwise reduce the distance between the camcorder and the access point.

Registering an access point using the WPS PIN method

You can register an access point by entering the PIN code of the access point.

1 Press the MENU button.

2 Select (NETWORK SET) → [Wi-Fi SET] → [ACCESS POINT SET] with the SEL/SET dial.

After a short delay, a list of access points that can be connected is displayed.

3 Select [Manual setting] → [WPS PIN].

Tip

- If ten access points have been registered in the camcorder, another access point cannot be registered and a message appears. Select [Delete], and delete any access points that are no longer required.

4 Enter the PIN code displayed on the camcorder screen, within two minutes, into the access point to which to connect.

- Connection to the access point is initiated.
- [Registered.] appears when the access point is registered successfully. The SSID of the registered access point is also displayed.

5 Select **[OK]** → **[X]**, and press the MENU button to close the menu screen.

Notes

- For details about the functions and settings supported by your access point, refer to the manual for the access point or contact the access point administrator.
- The camcorder and access point may not connect or the distance between them for successful communication may be short, depending on the surrounding environment, such as obstacles and walls, and the radio wave conditions. Move the camcorder or otherwise reduce the distance between the camcorder and the access point.

Registering an access point manually

1 Press the MENU button.

2 Select (NETWORK SET) → [Wi-Fi SET] → [ACCESS POINT SET] with the SEL/SET dial.

After a short delay, a list of access points that can be connected is displayed.

3 Select [Manual setting] → [Manual regist.].

Note

- If ten access points have been registered in the camcorder, another access point cannot be registered and a message appears. Select [Delete], and delete any access points that are no longer required.

4 Enter the SSID on the displayed screen, and select [Next].

5 Select the security method.

If [WEP] or [WPS] is displayed, enter the password on the displayed screen, and select [Next].

6 Configure the access point settings.

IP address

Select the IP address configuration method.

When [Manual] is selected, enter the IP address configuration items displayed on the screen, and select [OK].

Priority Connection

Select whether to configure connection priority for access points.

Tip

- Selecting [DNS server setting] on the IP ADDRESS SET screen will display the DNS server setting screen.

7 Select [Register].

- Connection to the access point is initiated.
- [Registered.] appears when the access point is registered successfully. The SSID of the registered access point is also displayed.

8 Select [OK] → [X], and press the MENU button to close the menu screen.

Changing the device name

1 Press the MENU button.

2 Select (NETWORK SET) → [Wi-Fi SET] → [EDIT DEVICE NAME] with the SEL/SET dial.

“Wi-Fi Direct” and other devices appear.

To rename a device, use the following procedure to enter a name from the keyboard.

How to use the keyboard

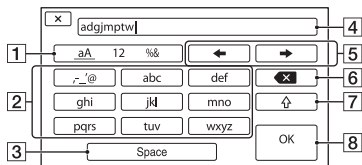

Screen items	Function
1 Switch character type	Characters switch between alphabetical letters, numerals, and symbols.
2 Keyboard	Characters are displayed in the order they are selected.
3 Space	Enters a space.
4 Input box	Entered characters are displayed.
5 Move cursor	Moves the cursor in the input box to the left or right
6 Delete	Deletes the character preceding the cursor
7 	Switches between uppercase and lowercase alphabetical letters
8 OK	Confirms an input operation

To cancel character during entry, press .

Resetting connection information

The connection information that you registered in order to use [CTRL W/ SMARTPHONE] can be reset.

1 Press the MENU button.

2 Select (NETWORK SET) → [Wi-Fi SET] → [SSID/PW RESET] with the SEL/SET dial.

A message appears.

Using network functions (continued)

3 Select [OK].

Note

- If the connection information has been reset, it will be necessary to set up the smartphone again in order to connect it to the camcorder.

Displaying the MAC address of the camcorder

1 Press the MENU button.

- #### 2 Select (NETWORK SET) → [Wi-Fi SET] → [DISP MAC ADDRESS] with the SEL/SET dial.
- The camcorder's MAC address appears.
-

Using airplane mode

Wi-Fi-related settings can be disabled (when boarding a plane, etc.).

1 Press the MENU button.

- #### 2 Select (NETWORK SET) → [AIRPLANE MODE] with the SEL/SET dial.
-

3 Select [ON].

Configuring a wired LAN

You can connect the camcorder to a network using a wired LAN.

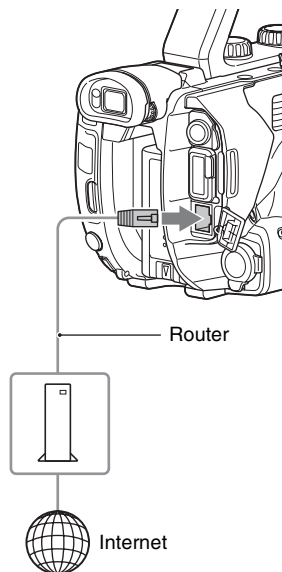

-
- #### 1 Connect the wired LAN jack of the camcorder to a router using a LAN cable (sold separately).
-

2 Press the MENU button.

- #### 3 Select (NETWORK SET) → [WIRED LAN SET] → [IP ADDRESS SET] with the SEL/SET dial.
-

4 Configure the access point settings.

IP address

Select the IP address configuration method.

When [Manual] is selected, enter the IP address configuration items displayed on the screen, and select [OK].

💡 Tip

- Selecting [DNS server setting] on the IP ADDRESS SET screen will display the DNS server setting screen.

Using the streaming function (STREAMING)

You can connect the camcorder to a network and stream a movie in real-time to external devices.

Streaming formats

There are limitations on the size of the original file movie and the streaming movie. For details, see “Streaming supported formats” (p. 183).

Configuring streaming (preset registration)

You configure streaming settings and register them using PRESET beforehand to distribute a stream using those settings. The following items can be configured.

SIZE

Select the image size for streaming.

- 1280×720
- 640×360

💡 Tip

- Select a size of “640×360” for increased streaming distribution stability.

DESTINATION SET

Configure the streaming distribution destination.

- **Host Name:** IP address or host name of the receiver
- **Port:** Port number used for streaming on the receiver

1 Press the MENU button.

2 Select (NETWORK SET) → [STREAMING] → desired PRESET number → configuration item with the SEL/SET dial.

3 Select/set the setting value.

4 Press the MENU button to return to the shooting screen.

Streaming distribution

You can distribute a stream of the movie being shot using the connected network.



1 Check that the network connection settings are successful (p. 92).

2 Press the MENU button.

3 Select (NETWORK SET) → [STREAMING] → [EXECUTE] → network connection method.

- The network connection starts.



- To cancel streaming, press the MENU button or press the ASSIGN button assigned with the [STREAMING] function or select .
- When connection is successful,  appears on the screen and the camcorder is ready to start streaming.

4 Press the THUMBNAIL button to start streaming distribution.

- The screen icon changes to .

Tips

- You can assign [STREAMING] to an ASSIGN button (p. 85). Pressing the ASSIGN button with the assigned function displays the network connection setup screen.
- You can assign [STREAM OPERATION] to an ASSIGN button. Pressing the ASSIGN button with the assigned function starts streaming distribution (p. 85).
- To simultaneously record XAVC or AVCHD movies to memory card and distribute a stream, start recording after the camcorder is in streaming standby state.
- If an error occurs during streaming distribution standby or during streaming distribution, a message appears. If [RECONNECT] appears, selecting it will attempt to reconnect the camcorder. Selecting [END] will disconnect the camcorder. Repeat the procedure from step 1 to reconnect.

Notes

- The streaming function is not available when using the following functions.
 - During playback
 - During thumbnail display
 - In the following formats when the file format is AVCHD:
 - 1080/60p, 1080/50p, 720/60p, 720/50p
 - In the following formats when the file format is XAVC QFHD:
 - 2160/30p 100Mbps, 2160/24p 100Mbps, 2160/25p 100Mbps
- The following functions are not available when the streaming function is on.
 - Slow & Quick Motion
 - PROXY REC MODE
 - Super Slow Motion
 - FACE DETECTION
 - COLOR BAR
 - CENTER SCAN
 - DATE REC
 - SIMULTANEOUS REC/RELAY REC
- Only wired LAN connection is supported when [AIRPLANE MODE] is set to [ON].
- Streaming distribution transmits the raw video and audio data via the Internet. Accordingly, the data may be disclosed to other parties.
- Check that the streaming data is being received by the receiving device.
- Data may be transmitted to a third party if the address or other settings are configured incorrectly.
- Some frames may not be played, depending on the network status.
- The image quality of fast-changing scenes may be adversely affected.

Camcorder operation during streaming

The following functions are enabled during streaming. Use the hardware switches and buttons to control the camcorder. Operation from the menu is not supported.

- Zooming
- Focusing
- To adjust the output audio level, adjust the input level using the AUDIO LEVEL dial.

- Exposure adjustment (iris, ISO sensitivity/gain and shutter speed)
- White balance

To stop streaming distribution

Press the **THUMBNAIL** button.

Tip

- You can also stop streaming distribution by pressing an ASSIGN button assigned with the [STREAM OPERATION] function (p. 85).
-

Using the FTP transfer function

When the camcorder is connected to a network, you can transfer recorded movie files directly to an FTP server. Proxy files can also be transferred.

Registering an FTP server

An FTP server must be registered in order to use FTP transfer. Up to three servers can be registered. This section describes the registration of FTP SERVER1 as an example.

1 Press the MENU button.

2 Select (NETWORK SET) → [FTP TRANSFER] → [FTP SERVER1] with the SEL/SET dial.

The FTP SERVER1 setup screen appears.

3 Select the item name of each setting, and enter the settings for FTP SERVER1.

Enter using the keyboard, then select [OK].

Tip

- For details about the keyboard input method, see page 95.

DISPLAY NAME

Enter the display name of the FTP server to register.

DESTINATION SET

- **Host Name:** Host name or IP address of the server
- **Secure Protocol:** Enable/disable secure FTP transfer
- **Port:** Port number of the FTP server
- **Directory:** Transfer destination directory

USER INFO SET

User name and password

Note

- It is recommended that [Secure Protocol] be set to [ON]. If set to [OFF], the user name, password, and movie file data may be disclosed to other parties if communication with the FTP server is intercepted or if connected to an unintended FTP server.
-

Selecting an FTP server

Select an FTP server to use for FTP transfer from the list of registered FTP servers.

1 Press the MENU button.

2 Select (NETWORK SET) → [FTP TRANSFER] → [FTP SERVER SELECT] with the SEL/SET dial.

3 Select the desired server.

Using FTP transfer

You can transfer files by FTP using the connected network.

1 Check that the network settings are configured (p. 92).

2 Press the THUMBNAIL button.

3 Select the media, where the files you want to transfer are stored, and the file format on the thumbnail screen.

4 Press the MENU button.

5 Select  (NETWORK SET) → [FTP TRANSFER] → [EXECUTE] → network connection method with the SEL/SET dial.

- The network connection starts.
- The thumbnail screen appears when connection to the FTP server is successful.
- If the file format is set to [XAVC] in step 3, select the file to transfer using “Main” and “PROXY.”

Tip

- You can assign this function to an ASSIGN button (p. 85).

6 Select the thumbnail of the file you want to transfer, and select [OK].

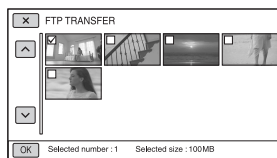

- Up to 100 files can be selected.
- Press the DISPLAY button to preview the image.
-  appears on the thumbnail of files that have a proxy file.

7 Select whether to turn the camcorder off (YES) or not (NO) automatically when the FTP transfer is completed.

- File transfer starts.

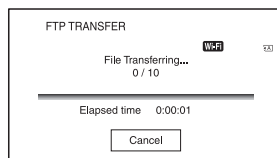

- To cancel the transfer, select [Cancel].
- If [YES] was selected in step 7, the camcorder turns off automatically when the transfer is completed. If [NO] was selected, select [OK]. You can also continue transferring files.

Notes

- Only files that were recorded by the camcorder can be transferred using FTP.
- Do not exchange a memory card after starting a file transfer.

- FTP transfer is not available in shooting mode. To start a file transfer, first press the THUMBNAIL button to switch to playback mode.
- Only wired LAN connection is supported when [AIRPLANE MODE] is set to [ON].

Checking FTP transfer results

You can check whether all files have been transferred. If the camcorder is configured to turn off automatically after transfer is completed, it is recommended that you check the transfer results.

1 Press the MENU button.

2 Select (NETWORK SET) → [FTP TRANSFER] → [FTP RESULT].

- The transfer results are displayed.
- The displayed transfer results contains the following items.

Date

Date and time of transfer start

Number of Contents

Number of transferred contents / total number of transfer contents

Result

Transfer result

Importing a root certificate

If [Secure Protocol] is set to [ON] for FTP transfer, a root certificate for authentication of the FTP server is required. The camcorder contains a built-in root certificate, which can also be updated. To update the root certificate, save the certificate on a memory card and then import the certificate from the memory card.

1 Write the root certificate to a memory card.

Write the certificate in PEM format with a “certification.pem” file name to the root directory of the memory card.

2 Insert the memory card with the root certificate into memory card slot A of the camcorder.

3 Press the MENU button.

4 Select (NETWORK SET) → [ROOT CERTIFICATE] → [OK] with the SEL/SET dial.

- The root certificate starts importing.
- The certificate is imported successfully when “Completed.” appears. Select to dismiss the screen.

Notes

- Do not eject the memory card while a certificate is being imported.
- Resetting network settings (p. 102) will delete the root certificate imported from the memory card, and will initialize the root certificate of the camcorder.

Note on wireless network function

We assume no responsibility whatsoever for any damage caused by unauthorized access to, or unauthorized use of, destinations loaded on the camcorder, resulting from loss or theft.

Using network functions (continued)

Security in the use of wireless LAN devices

- To avoid hacking, access by malicious third parties, and other vulnerabilities, confirm that the wireless LAN is always secure.
- It is very important to set up security on a wireless LAN.
- If a problem occurs due to inadequate security measures or due to foreseeable circumstances, Sony Corporation is not responsible for any resulting damage.

Resetting network settings

The following settings are reset when resetting network settings.

- SSID/password for smartphone operation
- Streaming settings (p. 97)
- FTP transfer settings (p. 99)
- FTP transfer result (p. 101)
- Wired LAN settings (p. 96)
- Access point settings (p. 92 to 95)
- Device name (p. 95)

1 Press the MENU button.

2 Select (NETWORK SET) → [NETWORK RESET] → [OK] with the SEL/SET dial.

Useful functions

Selecting suitable settings automatically (full auto mode setting)

You can optimize settings to suit the scene to record.

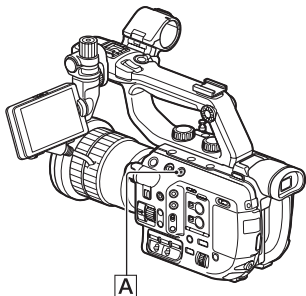

Press the FULL AUTO button to set full auto mode on.

The FULL AUTO button lamp turns on. The iris, ISO sensitivity/gain, shutter speed, and white balance are adjusted automatically. You cannot adjust them manually.

To set full auto mode off

Press the FULL AUTO button  to turn the indicator lamp off.

Notes

- When you set the FULL AUTO button on (lit), the iris, ISO sensitivity/gain, shutter speed, and white balance are adjusted automatically. You cannot adjust them manually.
- The following functions are not available when full auto mode is on.
 - Slow & Quick Motion
 - Super Slow Motion

Customizing the picture quality (Picture profile)

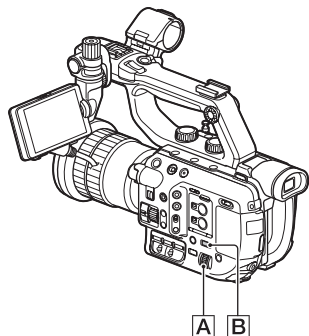

You can customize the picture quality by adjusting picture profile items, such as [GAMMA] and [DETAIL]. You can make adjustments for the time of day, weather conditions, or just personal preference. Connect your camcorder to a TV or monitor, and adjust the picture quality while observing the picture on the TV or monitor screen.

Picture quality settings for different recording conditions have been stored in [PP1] through [PP10] as default settings.

Picture profile number	Example setting
OFF	Do not use a picture profile.
PP1	Example settings of a color tone with [STANDARD] gamma
PP2	Example settings with color tone like an interchangeable-lens still camera movie with [STILL] gamma.
PP3	Example settings of natural color tone with [ITU709] gamma

Picture profile number	Example setting
PP4	Example settings of a color tone that is faithful to [ITU709]
PP5	Example settings of a color tone with [CINE1] gamma
PP6	Example settings of a color tone with [CINE2] gamma
PP7	Recommended setting when shooting using [S-LOG2] gamma
PP8	Recommended setting when shooting using [S-LOG3] gamma and S-GAMUT3.CINE color mode.
PP9	Recommended setting when shooting using [S-LOG3] gamma and S-GAMUT3 color mode.
PP10	Setting for shooting in HDR.

1 Press the MENU button **[B]**.

2 Select **[CAMERA/PAINT]** → **[PICTURE PROFILE]** → a desired number with the SEL/SET dial **[A]**, then press the dial.

You can record with the settings of the selected picture profile.

3 Select **[OK]** with the SEL/SET dial **[A]**, then press the dial.

Useful functions (continued)

Tip



- You can assign this function to an ASSIGN button (p. 85).

To cancel the picture profile recording

Select [OFF] in step **2** with the SEL/SET dial **[A]**, then press the dial.

To change the picture profile

You can change the settings stored in [PP1] through [PP10].

- ① Press the MENU button **[B]**.
- ② Select  (CAMERA/PAINT) → [PICTURE PROFILE] → picture profile number you want to change with the SEL/SET dial **[A]**, then press the dial.
- ③ Select [SETTING] with the SEL/SET dial **[A]**, then press the dial.
- ④ Select an item to be adjusted with the SEL/SET dial **[A]**, then press the dial.
- ⑤ Adjust the picture quality with the SEL/SET dial **[A]**, then press the dial.
- ⑥ Repeat steps ④ and ⑤ to adjust other items.
- ⑦ Select [ RETURN] with the SEL/SET dial **[A]**, then press the dial.
- ⑧ Select [OK] with the SEL/SET dial **[A]**, then press the dial.
A picture profile indicator appears.

BLACK LEVEL

To set the black level.

Item	Description and settings
	Sets the black level. -15 to +15

GAMMA

To select a gamma curve.

Item	Description and settings
[STANDARD]	Standard gamma curve for movies
[STILL]	Gamma curve like an interchangeable-lens still camera movie.
[CINE1]	Makes soft color images by decreasing dark area contrast and sharpening bright area tone changes (HG4609G33 equivalent).
[CINE2]	Almost the same effect as [CINE1]; select this if you want to treat the image in a range within 100% of video signal when editing, etc. (HG4600G30 equivalent).
[CINE3]	Increases contrast between bright areas and dark areas more than [CINE1] and [CINE2], sharpening dark area tone changes.
[CINE4]	Increases dark area contrast more than that of [CINE3]. The dark area contrast is weaker and the bright area contrast is stronger than that of [STANDARD].
[ITU709]	Gamma curve that corresponds to ITU-709. Gain in low intensity area: 4.5
[ITU709(800%)]	Gamma curve for checking scenes when shooting using [S-LOG2] or [S-LOG3].
[S-LOG2]	[S-LOG2] gamma curve. This setting presumes editing in post-production after recording.
[S-LOG3]	[S-LOG3] gamma curve. Gamma curve with characteristics similar to film, and which presumes editing in post-production after recording.

BLACK GAMMA

To correct gamma in low intensity area.

Item	Description and settings
[RANGE]	Selects a correcting range. HIGH / MIDDLE / LOW
[LEVEL]	Sets the correcting level. -7 (maximum black compression) to +7 (maximum black stretch)

Useful functions (continued)

KNEE

To set knee point and slope for video signal compression to prevent over-exposure by limiting signals in high intensity areas of the subject to the dynamic range of your camcorder.

When [GAMMA] is set to [CINE1], [CINE2], [CINE3], [CINE4], [STILL], [ITU709(800%)], [S-LOG2], or [S-LOG3], setting [MODE] to [AUTO] will set [KNEE] off. To use the [KNEE] function, set [MODE] to [MANUAL].

Item	Description and settings
[MODE]	Selects automatic or manual mode. [AUTO] : Sets the knee point and slope automatically. [MANUAL] : Sets the knee point and slope manually.
[AUTO SET]	Sets the maximum point and sensitivity in [AUTO] mode. [MAX POINT] : Sets the maximum value of the knee point. 90% to 100% [SENSITIVITY] : Sets the sensitivity. HIGH / MIDDLE / LOW
[MANUAL SET]	Sets the knee point and slope in [MANUAL] mode. [POINT] : Sets the knee point. 75% to 105% [SLOPE] : Sets the knee slope. -5 (gentle) to +5 (steep) [KNEE] is set off when you set to +5.

COLOR MODE

Selects the type of color.

Item	Description and settings
[STANDARD]	Suitable color tone when [GAMMA] is set to [STANDARD].
[STILL]	Suitable color tone when [GAMMA] is set to [STILL].
[CINEMA]	Suitable color tone when [GAMMA] is set to [CINE1].
[PRO]	Natural color tone when [GAMMA] is set to [ITU709].
[ITU709 MATRIX]	Gamma curve that corresponds to ITU-709.
[B/W]	Black and white.
[S-GAMUT/3200K]	Applies a combination of the following three settings and three color temperatures.
[S-GAMUT/4300K]	
[S-GAMUT/5500K]	S-GAMUT: Use when [GAMMA] is set to [S-LOG2], a setting that presumes editing in post-production after recording.
[S-GAMUT3.CINE/3200K]	S-GAMUT3.CINE: Use when [GAMMA] is set to [S-LOG3], a setting that presumes editing in post-production after recording.
[S-GAMUT3.CINE/4300K]	
[S-GAMUT3.CINE/5500K]	S-GAMUT3: Supports recording in a color gamut for easy adjustment to digital cinema color gamut. Use when [GAMMA] is set to [S-LOG3], a setting that presumes editing in post-production after recording. Supports recording with wide color gamut.
[S-GAMUT3/3200K]	
[S-GAMUT3/4300K]	
[S-GAMUT3/5500K]	
	3200K: 3200K color temperature
	4300K: 4300K color temperature
	5500K: 5500K color temperature

Note

- If S-GAMUT, S-GAMUT3, or S-GAMUT3.CINE is selected in [COLOR MODE], the setting is fixed to 3200, 4300, or 5500, according to the white balance setting.

SATURATION

To set the color level.

Item	Description and settings
	-32 (light) to +32 (dark)

COLOR PHASE

To set the color phase.

Item	Description and settings
	-7 (greenish) to +7 (reddish)

Useful functions (continued)

COLOR DEPTH

To set the color depth for each color phase.

This function is more effective for chromatic colors and less effective for achromatic colors. The color looks deeper as you increase the setting value to more positive side, and lighter as you decrease the value to more negative side.

Item	Description and settings
[R]	-7 (light red) to +7 (deep red)
[G]	-7 (light green) to +7 (deep green)
[B]	-7 (light blue) to +7 (deep blue)
[C]	-7 (light cyan) to +7 (deep cyan)
[M]	-7 (light magenta) to +7 (deep magenta)
[Y]	-7 (light yellow) to +7 (deep yellow)

COLOR CORRECTION

To set the color correction.

Item	Description and settings
TYPE	Selects color correction type. [OFF]: Not correct colors. [COLOR REVISION]: Corrects colors stored in memory. Colors not stored in memory (displayed in black and white when [COLOR EXTRACT] is set) will not be corrected. [COLOR EXTRACT]: Displays areas in colors that are stored in the memory. The other areas are displayed in black and white. You can use this function to add effects to your movies or to confirm the colors to be stored in the memory.
MEMORY SELECTION	Selects a memory to make active. [1]: Sets Memory 1 to be active. [2]: Sets Memory 2 to be active. [1&2]: Sets both Memory 1 and 2 to be active.
MEMORY1 COLOR	Sets colors stored in Memory 1. [PHASE]: Sets color phase. 0 (purple) to 8 (red) to 16 (yellow) to 24 (green) to 31 (blue) [PHASE RANGE]: Sets color phase range. 0 (no color selection), 1 (narrow: to select only a single color) to 31 (wide: to select multiple colors in similar color phase) [SATURATION]: Sets saturation. 0 (to select from light colors to dark colors) to 31 (to select dark color) [ONE PUSH SET]: Automatically sets [PHASE] for a subject at the center of the marker. [SATURATION] is set to 0.

Item	Description and settings
MEMORY1 REVISION	Corrects colors in Memory 1. [PHASE]: Corrects the phase of the color in Memory 1. -15 to +15 (0 for no correction.) [SATURATION]: Corrects the saturation of the color in Memory 1. -15 to +15 (0 for no correction.)
MEMORY2 COLOR	Sets colors stored in Memory 2. See [MEMORY1 COLOR] for description and settings.
MEMORY2 REVISION	Corrects colors in Memory 2. See [MEMORY1 REVISION] for description and settings.

Tips

- Setting both memories to the same setting doubles the color correction effect.
- The settings of [COLOR CORRECTION] will be retained even if the power is turned off. However, if you want to correct colors that may change according to time of the day, weather, location, etc., it is recommended that you set [COLOR CORRECTION] again prior to recording.
- If you change the white balance value or the settings of [WB SHIFT], [SATURATION] or [COLOR PHASE] of the picture profile, the settings of [PHASE RANGE] and [PHASE] of the selected memory will change. When you change the white balance value or the settings of the above picture profile items after you have set [PHASE RANGE] and [PHASE], check the settings of [COLOR CORRECTION] prior to recording.
- When the white balance is set in full auto mode, the white balance value automatically varies according to the lighting conditions of your recording environment. Manual white balance adjustment is recommended when you use [COLOR CORRECTION].

WB SHIFT

To set items for the white balance shift.

Items you can adjust differ depending on the filter type.

Item	Description and settings
[FILTER TYPE]	Selects a color filter type for the white balance shift. [LB-CC] : Film type (color conversion and correction) [R-B] : Video type (correction of R and B levels)
[LB[COLOR TEMP]]	Sets a color temperature offset value. -9 (bluish) to +9 (reddish)
[CC[MG/GR]]	Sets a color correct offset value. -9 (greenish) to +9 (magentish)
[R GAIN]	Sets an R level. -9 (low R level) to +9 (high R level)
[B GAIN]	Sets a B level. -9 (low B level) to +9 (high B level)

DETAIL

To set items for the detail.

Item	Description and settings
[LEVEL]	Sets the detail level. -7 to +7
[MANUAL SET]	[ON/OFF] : Turns on and off the manual detail adjustment. Set to [ON] to enable the manual detail adjustment (automatic optimization will not be performed).
	[V/H BALANCE] : Sets the vertical (V) and horizontal (H) balance of DETAIL. -2 (off to the vertical (V) side) to +2 (off to the horizontal (H) side)
	[B/W BALANCE] : Selects the balance of the lower DETAIL (B) and the upper DETAIL (W). TYPE1 (off to the lower DETAIL (B) side) to TYPE5 (off to the upper DETAIL (W) side)
	[LIMIT] : Sets the limit level of DETAIL. 0 (Low limit level: likely to be limited) to 7 (High limit level: not likely to be limited)
	[CRISPENING] : Sets the crispening level. 0 (shallow crispening level) to 7 (deep crispening level)
	[HI-LIGHT DETAIL] : Sets the DETAIL level in the high intensity areas. 0 to 4

COPY

To copy the settings of the picture profile to another picture profile number.

RESET

To reset the picture profile to the default setting.

To copy the picture profile setting to another picture profile number

- ① Press the MENU button **[B]**.
- ② Select **[CAMERA/PAINT]** → **[PICTURE PROFILE]** → picture profile number you want to copy with the SEL/SET dial **[A]**, then press the dial.
- ③ Select **[SETTING]** → **[COPY]** with the SEL/SET dial **[A]**, then press the dial.
- ④ Select the number of the picture profile that you want to copy to with the SEL/SET dial **[A]**, then press the dial.
- ⑤ Select **[YES]** → **[↵ RETURN]** → **[OK]** with the SEL/SET dial **[A]**.

To reset the picture profile settings

You can reset the picture profile settings by each picture profile number. You cannot reset all picture profile settings at once.

- ① Press the MENU button **[B]**.
- ② Select **[CAMERA/PAINT]** → **[PICTURE PROFILE]** → target picture profile number with the SEL/SET dial **[A]**, then press the dial.
- ③ Select **[SETTING]** → **[RESET]** → **[YES]** → **[↵ RETURN]** → **[OK]** with the SEL/SET dial **[A]**.

Using the gamma display assist function

Movies shot using S-Log2 or S-Log3 require editing in post production. These images have low contrast, that make live monitoring difficult. To preview the video, you can use **[GAMMA DISP ASSIST]** to convert the video for display in the viewfinder or on the LCD screen.

This function affects only the monitoring video or playback video displayed in the viewfinder or on the LCD screen. The recorded video and output video is not affected.

1 Press the MENU button.

2 Select **[DISPLAY SET]** → **[GAMMA DISP ASSIST]** → **[ON]** with the SEL/SET dial.

3 Select **[DISPLAY SET]** → **[GAMMA DISP ASSIST]** → **[TYPE]** with the SEL/SET dial.

4 Select the desired value with the SEL/SET dial.

AUTO: If the gamma is set to **[S-LOG2]** in **[PICTURE PROFILE]**, selects **[S-LOG2→709(800%)]** to convert the video for display. If **[S-LOG3]** is set, selects **[S-LOG3→709(800%)]**.

S-LOG2→709(800%): Converts S-LOG2 to ITU-709(800%) equivalent for display.

Useful functions (continued)

S-LOG3→709(800%): Converts S-LOG3 to ITU-709(800%) equivalent for display.

Note

- If [AUTO] is selected for playback, the video is converted for display according to the gamma settings in [PICTURE PROFILE], not the gamma setting (S-LOG2/S-LOG3) of the playback video.

Tip

- You can assign this function to an ASSIGN button (p. 85).

Setting time data

The camcorder records movies accompanied by time data, such as time code and user bit.

Setting the time code

- ① Press the MENU button and select **00:00** (TC/UB SET) → [TC PRESET] with the SEL/SET dial, then press the dial.
- ② Select [PRESET] with the SEL/SET dial, then press the dial.
- ③ Select the first 2 digits with the SEL/SET dial, then press the dial. You can set the time code within the following range.
When [60i] is selected:
00:00:00:00 to 23:59:59:29
 - When setting 24p, you can set the last 2 time digits to 00, 02, 08, 12, 16, or 20.When [50i] is selected:
00:00:00:00 to 23:59:59:24
- ④ Set other digits by repeating step ③.
- ⑤ Select [OK] with the SEL/SET dial, then press the dial.

To reset the time code

Select [RESET] in step ② of “Setting the time code” above to reset the time code (00:00:00:00).

To reset the time code using the Wireless Remote Commander

Press the TC RESET button on the Wireless Remote Commander to reset the time code (00:00:00:00).

Setting the user bits

- ① Press the MENU button and select **00:00** (TC/UB SET) → [UB PRESET] with the SEL/SET dial, then press the dial.
- ② Select [PRESET] with the SEL/SET dial, then press the dial.
- ③ Select the first 2 digits with the SEL/SET dial, then press the dial.
- ④ Set other digits by repeating step ③.
- ⑤ Select [OK] with the SEL/SET dial, then press the dial.

To reset the user bits

Select [RESET] in step ② of “Setting the user bits” above to reset the user bits (00 00 00 00).

Preventing accidental operation (HOLD switch)

This locks the buttons and switches to prevent recording errors by accidental operation.

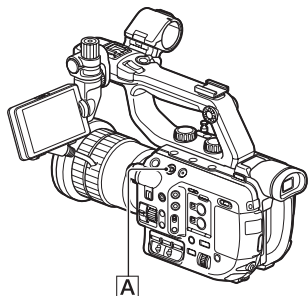

Slide the HOLD switch **A** in the direction of the arrow.

To cancel the setting

Slide the HOLD switch **A** in the opposite direction of the arrow so that the yellow part is not visible.

Note

- You cannot lock the following buttons and switches.
 - ON/STANDBY switch (camcorder)
 - AUDIO LEVEL (CH-1/CH-2) dials (camcorder)
 - ND FILTER dial (camcorder)
 - FOCUS (AUTO/MAN) switch (camcorder)
 - ISO/GAIN — L/M/H switch (camcorder)
 - WHT BAL — B/A/PRESET switch (camcorder)
 - PRESET/VARIABLE switch (camcorder)
 - INPUT 1 switch (camcorder)
 - INPUT 2 switch (handle)
 - Grip rotate lever (grip)
 - LCD ON/OFF switch (LCD screen)

- MIRROR switch (LCD screen)
- Lens switches (lens)

Tip

- You can change the functions to be locked with [HOLD SW SET] (p. 166).

Reviewing the most recently recorded scene (Last Scene Review)

You can review the most recently recorded scene on the LCD screen. This function is available when the function is assigned to an ASSIGN button.

1 Assign [LAST SCENE REVIEW] to an ASSIGN button beforehand (p. 85).

2 After you stop recording, press the assigned ASSIGN button.

The camcorder plays from the start to the end of the most recently recorded scene, then returns to standby mode.

To stop reviewing the last scene

Press the ASSIGN button during playback. Review stops, and the camcorder returns to standby mode.

Notes

- If you edit the movie or remove the media after you stop recording, the Last Scene Review function may not work correctly.
- Last Scene Review is not available in Super Slow Motion mode.

Tip

- You can assign this function to an ASSIGN button (p. 85).

Useful functions (continued)

Inverting the LCD screen display

You can flip the screen display up/down or up/down/left/right using the MIRROR switch on the LCD screen, and turn the LCD screen 180° towards the lens so that the camcorder can be controlled from the lens side.

MIRROR switch position	Display state	Example display*
OFF	The image is not inverted (normal position display).	Refer to the following diagrams.
B/T	The image is inverted vertically (bottom/top). The information display is inverted horizontally and vertically.	
ROTATE	The information display is inverted horizontally and vertically.	

* The information display in the example diagrams below are shown larger than normal to emphasize the inverted state.

OFF

The image is not inverted.



B/T

The image is inverted vertically (bottom/top).

The information indicators are inverted horizontally and vertically.

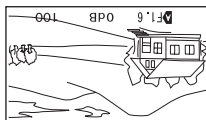

Tip

- Time data is not displayed when the switch is set to "B/T."

ROTATE

The image is inverted horizontally and vertically.

The information indicators are inverted horizontally and vertically.

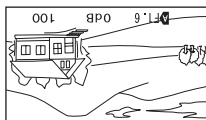

Tip

- The B/T and ROTATE switch positions affect the display on the LCD screen only. The output image and recorded image are not affected.

GPS function

* On the PXW-FS5, this function is supported using Ver. 2.0 or later (see page 5).

GPS function compatible devices

You can use the GPS function on models with a GPS logo marked on the handle.

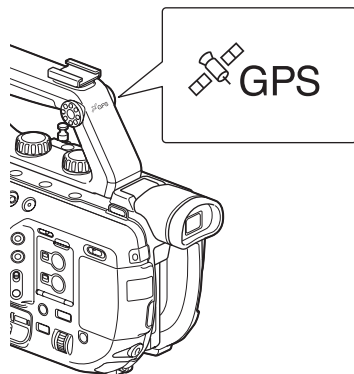

Notes

- The GPS receiver is built into the handle. Accordingly, the GPS function cannot be used when the handle is not attached.
- GPS position information can be recorded when shooting in XAVC or AVCHD. GPS information is not recorded in proxy recordings or RAW recordings.

Acquiring position information

Set (SYSTEM) → [GPS SETTING] in the menu to ON.

appears, and the camcorder starts searching for signals. When triangulation is established, position information is recorded when shooting video.

Notes

- The icon displayed on the screen varies according to the strength of signal reception from GPS satellites.

Triangulation status	Screen indicators	GPS reception status
Off	No indicator	[GPS SETTING] is set to [OFF] or an error occurred.
Not available		Position information could not be obtained because a GPS signal could not be received. Move to a location with a clear view of the sky.
Searching for satellites		Searching for GPS satellites. Several minutes may be required to acquire satellites.
Triangulating		A weak GPS signal is being received.
Triangulating		A GPS signal is being received. Position information can be acquired.
Triangulating		A strong GPS signal is being received. Position information can be acquired.

- [GPS SETTING] is set to [ON] by default. Position information and time information are recorded with the video when the GPS function is on. If you do not want to record position information, set [GPS SETTING] to [OFF].
- If a triangulating icon is not displayed after several minutes, there may be a problem with signal reception. You can start shooting without position information, or move to an area with a clear view of the sky. Shooting when a

GPS function (continued)

triangulating icon is not displayed means that position information will not be recorded.

- The GPS signal may not be received when indoors or near tall structures. Move to a location with a clear view of the sky.
- The recording of position information may be interrupted, depending on the strength of the received signal, even if a triangulating icon is displayed.
- If a GPS signal received is reflected off buildings or other structures, or the received GPS signal strength is weak, there may be an error of up to several hundred meters in the position information.

Displaying position information using the data code function

To display recorded position information during playback, select  (DISPLAY SET) → [DATA CODE] → [COORDINATES] in the menu.

The latitude and longitude appear in the bottom left of the screen.

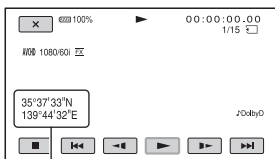

Position information

Tip

- [--° --' --" -] is displayed when shooting if a GPS signal cannot be received.

GPS INFORMATION

Displays position information.

Set  (SYSTEM) → [GPS INFORMATION] in the menu to ON.

Satellite icons

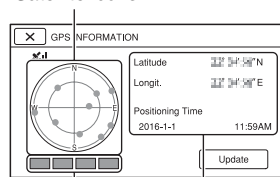

Triangulation gauge

Last received position information

Acquired information symbols

Color of satellites/triangulation gauge	Status
●/■ (black)	No signal, but orbit information for the satellite is available.
●/■ (gray)	33% of orbit information acquired
●/■ (brown)	66% of orbit information acquired
●/■ (ocher)	99% of orbit information acquired
●/■ (green)	Satellite is in use

- When position information cannot be received, triangulation priority mode is activated. All other functions stop and the camcorder searches for satellites, making it easier to receive position information.
- To receive position information manually, press the [Update] button.
- To close the GPS information screen, press .

AUTO CLOCK ADJ

Maintains accurate time by acquiring time information using GPS.

Set  (SYSTEM) → [AUTO CLOCK ADJ] in the menu to ON.

Notes

- Adjust the date and time on your camcorder before using your camcorder.
- There may be discrepancies of a few seconds even when [AUTO CLOCK ADJ] is activated.
- [AUTO CLOCK ADJ] automatically adjusts the clock when the camcorder receives GPS signals and finishes triangulating successfully while the power is on. Once the clock is adjusted, it will not be adjusted until the next time you turn the camcorder on again.
- [AUTO CLOCK ADJ] may not be adjusted to the correct time, depending on the country/region. In this case, set [AUTO CLOCK ADJ] to [OFF].

AUTO AREA ADJ

Automatically corrects for time differences detected using location information acquired by GPS.

Set  (SYSTEM) → [AUTO AREA ADJ] in the menu to ON.

Notes

- Adjust the date and time on your camcorder before using your camcorder.
- There may be discrepancies of a few seconds even when [AUTO AREA ADJ] is activated.
- [AUTO AREA ADJ] may not be adjusted to the correct time, depending on the country/region. In this case, set [AUTO AREA ADJ] to [OFF].

About GPS

The GPS (Global Positioning System) is a system that calculates geographical location from highly accurate US space satellites. This system allows you to pinpoint your exact location on the earth.

The GPS satellites are located in 6 orbits, 20,000 km above the earth. The GPS system consists of 24 or more GPS satellites. A GPS receiver receives radio signals from the satellites, and calculates the current location of the receiver based on the orbital information (almanac data) and travel time of the signals, etc.

Determining a location is called “triangulation.” A GPS receiver can

determine the location’s latitude and longitude by receiving signals from 3 or more satellites.

- As the positions of GPS satellites vary constantly, it may take longer to determine the location or the receiver may not be able to determine the location at all, depending on the location and time you use the camcorder.
- “GPS” is a system for determining geographic location by triangulating radio signals from GPS satellites. Avoid using the camcorder in places where radio signals are blocked or reflected, such as a shadowy place surrounded by buildings or trees, etc. Use the camcorder in open sky environments.
- You may not be able to record position information at locations or in situations where radio signals from the GPS satellites do not reach the camcorder as follows.
 - In tunnels, indoors, or under the shade of buildings.
 - Between tall buildings or in narrow streets surrounded by buildings.
 - In underground locations, locations surrounded by dense trees, under an elevated bridge, or in locations where magnetic fields are generated, such as near high voltage cables.
 - Near devices that generate radio signals of the same frequency band as the camcorder: near 1.5 GHz band mobile telephones, etc.

About triangulation errors

- If you move to another location right after setting [GPS SETTING] to [ON] in the menu, it may take a longer time for the camcorder to start triangulating, compared to when you stay in the same place.
- Error caused by the position of GPS satellites
The camcorder automatically triangulates your current location when the camcorder

GPS function (continued)

receives radio signals from 3 or more GPS satellites. The triangulation error of the GPS satellites is about 10 m (33 feet). Depending on the environment of the location, the triangulation error can be greater. In this case, your actual location may not match the location on the map based on the GPS information. Also, the GPS satellites are controlled by the United States Department of Defense, and the degree of accuracy may be changed intentionally.

- Error during the triangulation process
The camcorder acquires position information periodically during triangulation.

About restrictions on use of GPS

Use GPS in accordance with the regulations of the situation, the countries/regions of use.

About the geographic coordinate system

The “WGS-84” geographic coordinate system is used.

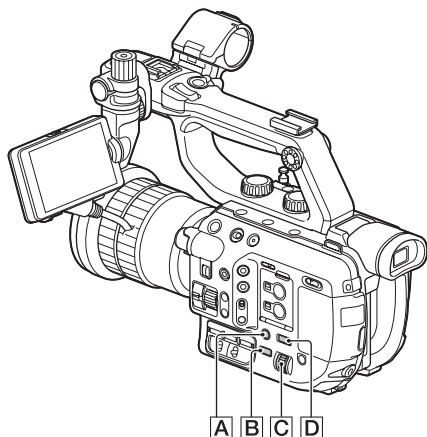

Playback

1 Press the THUMBNAIL button [B].

The thumbnail screen appears.

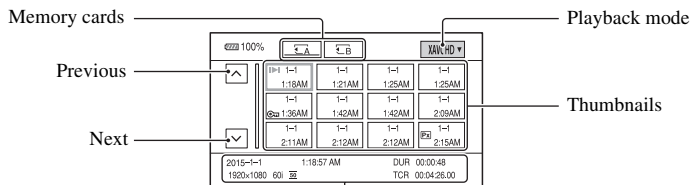

(p. 120)

- You can turn on/off the date and time display on the thumbnails by pressing the DISPLAY button [A].
- Icons may also be displayed on thumbnails.

Proxy recording (p. 49) icon



Protected (p. 134) icon



2 Play back a recording.

- ① Select the memory card you want to play back with the SEL/SET dial **[C]**.

[A] : Memory card A

[B] : Memory card B

- ② Select the playback mode with the SEL/SET dial **[C]**.

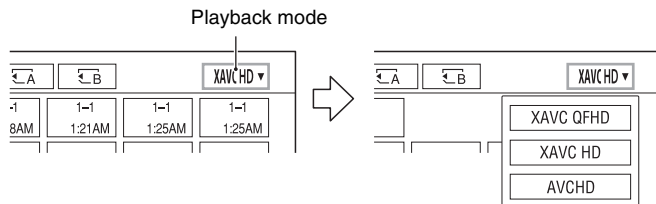

- XAVC QFHD
- XAVC HD
- AVCHD

- ③ Select the thumbnail of the movie you want to play back with the SEL/SET dial **[C]**.
Information about the movie appears in the lower part of the LCD screen.

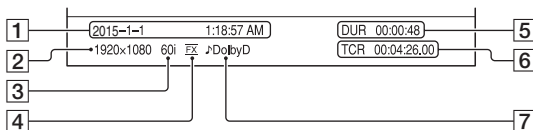

1 Date and time of recording start

2 Resolution

3 Frame rate

4 Bit rate

5 Recording time

6 Time code of recording start

Time code will not be displayed correctly when you play back a memory card with no time code, or a memory card with time code that your camcorder does not support.

7 DOLBY DIGITAL recording

Displayed when audio is recorded in Dolby Digital format in AVCHD.

- **|▶** appears on the thumbnail for the movie that has been most recently played back or recorded. Selecting it will continue playback from the previous time.

- ④ Press the SEL/SET dial **[C]**.

Playback starts.

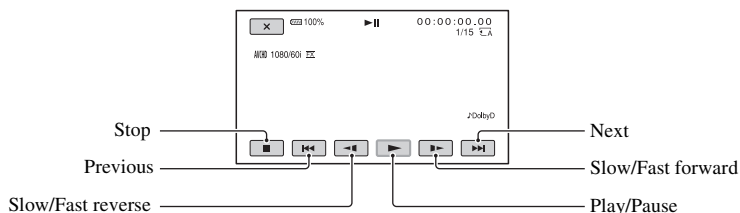

Tips

- You can assign the [THUMBNAIL] button function to an ASSIGN button.
- When playback from the selected movie reaches the last movie, the screen returns to the thumbnail screen.
- Select ◀/▶ during pause to play back movies slowly.
- As you select ◀/▶ during playback, movies are played back at about 5 times → about 10 times → about 30 times → about 60 times normal speed.

To adjust the volume

Press the MENU button [D] and select 🎵 (AUDIO SET) → [VOLUME] to adjust the volume.

To return to recording mode

Press the THUMBNAIL button [B].

On playing back movies

- Movies recorded using this camcorder may not be played back normally on devices other than this camcorder. Also, movies recorded on other devices may not play back properly on this camcorder.

Changing/checking the settings in your camcorder

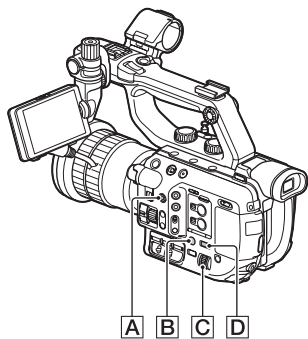

Changing the screen display

You can display information, such as time code, etc., on the image.

Press the DISPLAY button **B**.

The screen indicators turn on (displayed) ↔ off (not displayed) each time you press the button. In recording mode, the screen changes in the order, detailed display → simple display → no display with each press of the button.

💡 Tips

- You can display the screen indicators during playback on a TV by setting [DISPLAY OUTPUT] to [ALL OUTPUT] (p. 161).
- You can assign this function to an ASSIGN button (p. 85).

Displaying recording data (Data code)

You can display information, including date, time and camera data automatically stored during recording on the screen during playback.

1 Press the MENU button **D**.

2 Select **DISP** (DISPLAY SET) → [DATA CODE] with the SEL/SET dial **C**, or press the ASSIGN button assigned with the DATA CODE function during playback or pause.

The screen changes in the order, date and time display → camera data display → no display with each press of the button.

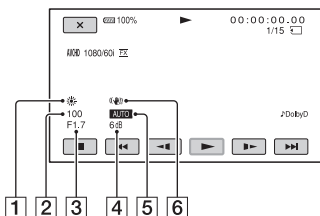

1 White balance **PWB** appears during playback of a movie recorded with [MANU WB TEMP].

2 Shutter speed

3 Iris

4 ISO sensitivity/gain

5 Exposure

AUTO appears during playback of the movie recorded with the iris, ISO sensitivity/gain, and shutter speed automatically adjusted.

MANUAL appears during playback of the movie recorded with the iris, ISO sensitivity/gain, and shutter speed manually adjusted.

6 SteadyShot

Notes

- Data code cannot be displayed for XAVC QFHD or XAVC HD.
- When you play back the memory card on other devices, the camera data may be displayed incorrectly. Confirm the correct camera data on your camcorder.

Checking the camcorder settings (Status check)

You can check the settings of the following items.

- Audio setup (p. 155)
- Output signal setup (p. 153)
- Functions assigned to the ASSIGN buttons (p. 85)
- Camera setup (p. 147)
- Record button setup (p. 42)
- Memory card information
You can check the estimated used and free space.

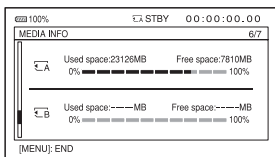

Battery Info

You can check the remaining capacity of the attached battery.

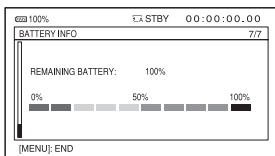

1 Press the STATUS button [A].

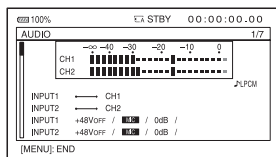

2 Turn the SEL/SET dial [C] until the desired item appears on the LCD screen.

Switches in the order AUDIO → OUTPUT → ASSIGN → CAMERA → REC BUTTON SET → MEDIA INFO → BATTERY INFO.

Setup items are displayed according to the settings of the camcorder when it is turned on.

To hide the display

Press the STATUS button [A].

Tip

- You can assign this function to an ASSIGN button (p. 85).

Connecting to a monitor or a TV

Playback image quality depends on the type of monitor or TV, and the jacks used to make the connection.

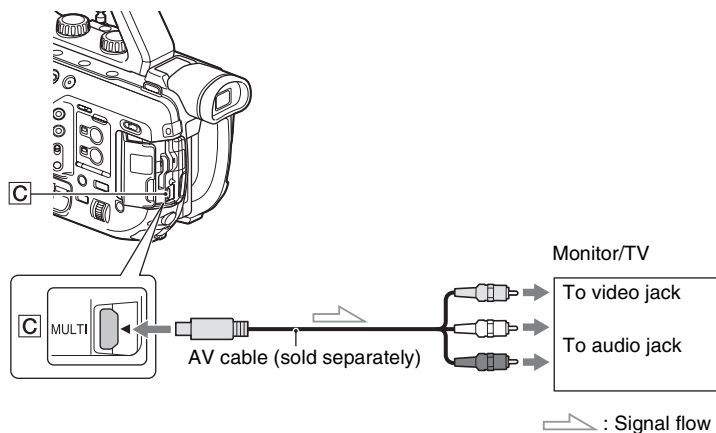
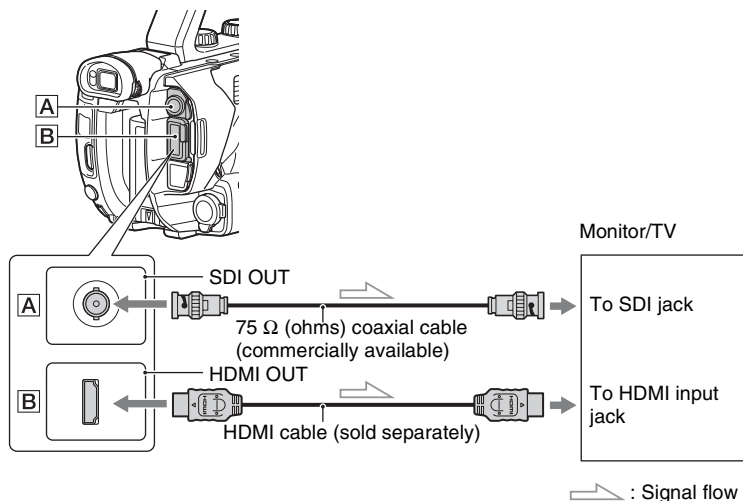

Notes

- Video signals cannot be output simultaneously from the jacks in the diagram above.
- A signal cannot be output from the jacks above when recording in 4K mode (XAVC QFHD).

💡 Tip

- VIDEO OUT and AUDIO OUT are integrated into the Multi/Micro USB jack. To connect to the video jack or audio jack of a monitor or TV, an AV cable (sold separately) is required. VMC-15MR2 is recommended.

Selecting jacks for external output

- 1 Press the MENU button.
- 2 Select \leftarrow (REC/OUT SET) \rightarrow [OUTPUT SELECT] \rightarrow the jack that you want to use for output with the SEL/SET dial.

Output signal formats

The signal format of the outputs from the SDI OUT jack, HDMI OUT jack, and multi/micro USB jack is shown below.

SDI OUT output format (when [60i] is selected)

--: Independent of set value

Menu item						
Recording mode	Recording format	SDI/HDMI	24p/30p	SDI OUT output signal format		
REC/OUT SET>	REC/OUT SET>	REC/OUT SET>	REC/OUT SET>			
REC SET>	REC SET>	VIDEO OUT>	VIDEO OUT>			
FILE FORMAT	REC FORMAT	SDI/HDMI	24p/30p			
XAVC QFHD	2160/24p	2160p/1080p/480i	24p/30p	1080/24p		
			24PsF/30PsF	1080/24psf		
			60p(Pull Down)	1080/60p		
				2160p/720p/480i	--	720/60p
				2160p/1080i/480i		1080/60i
				1080p/480i	24p/30p	1080/24p
					24PsF/30PsF	1080/24psf
					60p(Pull Down)	1080/60p
				720p/480i	--	720/60p
				1080i/480i		1080/60i
				480p		No output
				480i		480/60i

Connecting to a monitor or a TV (continued)

Menu item					
Recording mode	Recording format	SDI/HDMI	24p/30p	SDI OUT output signal format	
REC/OUT SET>	REC/OUT SET>	REC/OUT SET>	REC/OUT SET>		
REC SET>	REC SET>	VIDEO OUT>	VIDEO OUT>		
FILE FORMAT	REC FORMAT	SDI/HDMI	24p/30p		
	2160/30p	2160p/1080p/480i	24p/30p		1080/30p
			24PsF/30PsF		1080/30psf
			60P(Pull Down)		1080/60p
		2160p/720p/480i	–		720/60p
		2160p/1080i/480i			1080/60i
		1080p/480i	24p/30p		1080/30p
			24PsF/30PsF		1080/30psf
			60p(Pull Down)		1080/60p
		720p/480i	–		720/60p
		1080i/480i			1080/60i
		480p			No output
		480i			480/60i
XAVC HD	1080/24p	2160p/1080p/480i	24p/30p		1080/24p
AVCHD			24PsF/30PsF		1080/24psf
			60p(Pull Down)		1080/60p
		2160p/720p/480i	–		720/60p
		2160p/1080i/480i			1080/60i
		1080p/480i	24p/30p	1080/24p	
			24PsF/30PsF	1080/24psf	
			60p(Pull Down)	1080/60p	
		720p/480i	–	720/60p	
		1080i/480i		1080/60i	
		480p		No output	
		480i		480/60i	

Menu item				
Recording mode	Recording format	SDI/HDMI	24p/30p	SDI OUT output signal format
REC/OUT SET>	REC/OUT SET>	REC/OUT SET>	REC/OUT SET>	SDI OUT output signal format
REC SET>	REC SET>	VIDEO OUT>	VIDEO OUT>	
FILE FORMAT	REC FORMAT	SDI/HDMI	24p/30p	
	1080/30p	2160p/1080p/480i	24p/30p	1080/30p
			24PsF/30PsF	1080/30psf
			60p(Pull Down)	1080/60p
		2160p/720p/480i	–	720/60p
		2160p/1080i/480i		1080/60i
		1080p/480i	24p/30p	1080/30p
			24PsF/30PsF	1080/30psf
			60p(Pull Down)	1080/60p
		720p/480i	–	720/60p
		1080i/480i		1080/60i
		480p		No output
		480i		480/60i
	1080/60p	2160p/1080p/480i	–	1080/60p
	720/60p	2160p/720p/480i		720/60p
	1080/60i	2160p/1080i/480i		1080/60i
		1080p/480i		1080/60p
		720p/480i		720/60p
		1080i/480i		1080/60i
		480p		No output
		480i		480/60i

Connecting to a monitor or a TV (continued)

HDMI OUT output format (when [60i] is selected)

--: Independent of set value

Menu item						
Recording mode	Recording format	SDI/HDMI	24p/30p	HDMI OUT output signal format		
REC/OUT SET> REC SET> FILE FORMAT	REC/OUT SET> REC SET> REC FORMAT	REC/OUT SET> VIDEO OUT> SDI/HDMI	REC/OUT SET> VIDEO OUT> 24p/30p			
XAVC QFHD	2160/24p	2160p/1080p/ 480i	–	2160/24p		
		2160p/720p/480i				
		2160p/1080i/480i				
		1080p/480i	24p/30p	During recording: 1080/24p		
			24PsF/30PsF	During playback: 1080/60p		
			60p(Pull Down)	1080/60p		
		720p/480i	–	720/60p		
		1080i/480i		1080/60i		
		480p		480/60p		
		480i		480/60i		
		2160/30p	2160p/1080p/ 480i	2160p/1080p/ 480i	–	2160/30p
				2160p/720p/480i		
				2160p/1080i/480i		
				1080p/480i	–	1080/60p
720p/480i				720/60p		
1080i/480i				1080/60i		
	480p		480/60p			
	480i		480/60i			

Menu item					
Recording mode	Recording format	SDI/HDMI	24p/30p	HDMI OUT output signal format	
REC/OUT SET>	REC/OUT SET>	REC/OUT SET>	REC/OUT SET>	HDMI OUT output signal format	
REC SET>	REC SET>	VIDEO OUT>	VIDEO OUT>		
FILE FORMAT	REC FORMAT	SDI/HDMI	24p/30p		
XAVC HD	1080/24p	2160p/1080p/480i	24p/30p	During recording: 1080/24p	
AVCHD			24PsF/30PsF	During playback: 1080/60p	
			60p(Pull Down)	1080/60p	
		2160p/720p/480i	–	720/60p	
		2160p/1080i/480i		1080/60i	
		1080p/480i	24p/30p	During recording: 1080/24p	
			24PsF/30PsF	During playback: 1080/60p	
			60p(Pull Down)	1080/60p	
			720p/480i	–	720/60p
			1080i/480i		1080/60i
			480p		480/60p
		480i		480/60i	
		1080/30p	2160p/1080p/480i	–	1080/60p
	2160p/720p/480i			720/60p	
	2160p/1080i/480i			1080/60i	
	1080p/480i			1080/60p	
	720p/480i			720/60p	
	1080i/480i			1080/60i	
	480p			480/60p	
	480i			480/60i	
	1080/60p 720/60p 1080/60i	2160p/1080p/480i	–	1080/60p	
		2160p/720p/480i		720/60p	
		2160p/1080i/480i		1080/60i	
		1080p/480i		1080/60p	
		720p/480i		720/60p	
		1080i/480i		1080/60i	
		480p		480/60p	
		480i		480/60i	

Connecting to a monitor or a TV (continued)

Multi/micro USB jack output format (when [60i] is selected)

Output is always 480/60i.

SDI OUT output format (when [50i] is selected)

--: Independent of set value

Menu item						
Recording mode	Recording format	SDI/HDMI	50p	SDI OUT output signal format		
REC/OUT SET> REC SET> FILE FORMAT	REC/OUT SET> REC SET> REC FORMAT	REC/OUT SET> VIDEO OUT> SDI/HDMI	REC/OUT SET> VIDEO OUT> 50p			
XAVC QFHD	2160/25p	2160p/1080p/ 576i	25p	1080/25p		
			25PsF	1080/25psf		
			50p	1080/50p		
		2160p/720p/576i	–	720/50p		
		2160p/1080i/576i		1080/50i		
		1080p/576i	25p	1080/25p		
			25PsF	1080/25psf		
			50p	1080/50p		
		720p/576i	–	720/50p		
		1080i/480i		1080/50i		
		576p		No output		
		576i		576/50i		
		XAVC HD AVCHD	1080/25p	2160p/1080p/ 576i	25p	1080/25p
					25PsF	1080/25psf
50p	1080/50p					
2160p/720p/576i	–			720/50p		
2160p/1080i/576i				1080/50i		
1080p/576i	25p			1080/25p		
	25PsF			1080/25psf		
	50p			1080/50p		
720p/576i	–			720/50p		
1080i/576i				1080/50i		
576p				No output		
576i				576/50i		

Menu item				
Recording mode	Recording format	SDI/HDMI	50p	SDI OUT output signal format
REC/OUT SET>	REC/OUT SET>	REC/OUT SET>	REC/OUT SET>	
REC SET>	REC SET>	VIDEO OUT>	VIDEO OUT>	
FILE FORMAT	REC FORMAT	SDI/HDMI	50p	
	1080/50p	2160p/1080p/	–	
	720/50p	576i		
	1080/50i	2160p/720p/576i		
		2160p/1080i/576i		
		1080p/576i		
		720p/576i		
		1080i/576i		
		576p		
		576i		
				1080/50p
				720/50p
				1080/50i
				1080/50p
				720/50p
				1080/50i
				No output
				576/50i

HDMI OUT output format (when [50i] is selected)

–: Independent of set value

Menu item				
Recording mode	Recording format	SDI/HDMI	50p	HDMI OUT output signal format
REC/OUT SET>	REC/OUT SET>	REC/OUT SET>	REC/OUT SET>	
REC SET>	REC SET>	VIDEO OUT>	VIDEO OUT>	
FILE FORMAT	REC FORMAT	SDI/HDMI	50p	
XAVC QFHD	2160/25p	2160p/1080p/	–	
		576i		
		2160p/720p/576i		
		2160p/1080i/576i		
		1080p/576i		
		720p/576i		
		1080i/480i		
		576p		
		576i		
				2160/25p
				1080/50p
				720/50p
				1080/50i
				576/50p
				576/50i

Connecting to a monitor or a TV (continued)

Menu item					
Recording mode	Recording format	SDI/HDMI	50p	HDMI OUT output signal format	
REC/OUT SET>	REC/OUT SET>	REC/OUT SET>	REC/OUT SET>	HDMI OUT output signal format	
REC SET>	REC SET>	VIDEO OUT>	VIDEO OUT>		
FILE FORMAT	REC FORMAT	SDI/HDMI	50p		
XAVC HD	1080/25p	2160p/1080p/	–	1080/50p	
AVCHD		576i			
		2160p/720p/576i		720/50p	
		2160p/1080i/576i		1080/50i	
		1080p/576i		1080/50p	
		720p/576i		720/50p	
		1080i/576i		1080/50i	
		576p		576/50p	
		576i		576/50i	
		1080/50p	2160p/1080p/	–	1080/50p
		720/50p	576i		
		1080/50i	2160p/720p/576i		720/50p
			2160p/1080i/576i		1080/50i
			1080p/576i		1080/50p
		720p/576i		720/50p	
		1080i/576i		1080/50i	
		576p		576/50p	
		576i		576/50i	

Multi/micro USB jack output format (when [50i] is selected)

Output is always 576/50i.

Output in Slow & Quick Motion/Super Slow Motion mode

- For XAVC QFHD 2160/24p, the output in Slow & Quick Motion mode is the same as when the recording format is 2160/30p.
- For XAVC HD/AVCHD, when shooting in Slow & Quick Motion/Super Slow Motion mode in a recording format with frame rate of 30p or 24p, the output is either 60p or 60i. When the recording format frame rate is 25p, the output is either 50p or 50i.

🔊 Notes

- It is recommended that you use an authorized cable with HDMI logo or a Sony HDMI cable.
- Images are not output from the HDMI OUT jack of your camcorder, if copyright protection signals are recorded in the movies.
- Images and sounds may not be reproduced correctly on some monitors or TVs.
- Do not connect the output jacks of the camcorder with the output jacks of the monitor or TV. A malfunction may be caused.
- If you display the edit screen while outputting signals to a monitor or TV, the menu may not be displayed correctly.

- This camcorder is not compatible with “BRAVIA” sync.

External output and face detection support when recording in XAVC QFHD (4K mode)

Select  REC/OUT SET menu → [VIDEO OUT] → [OUTPUT SELECT].

REC/OUT SET menu → [VIDEO OUT] → [OUTPUT SELECT]		
Item	Settings (default setting in bold)	Description
[OUTPUT SELECT]	SDI, HDMI , VIDEO	Selects the external output destination.
[QFHD REC OUTPUT]	VF/LCD PANEL , EXTERNAL OUTPUT	Selects the output destination for video signals while recording in QFHD. VF/LCD PANEL: Viewfinder/LCD panel EXTERNAL OUTPUT: External output selected in [OUTPUT SELECT] above.

The picture being recorded is not displayed on the viewfinder/LCD panel when [QFHD REC OUTPUT] is set to [EXTERNAL OUTPUT].

Notes

- The picture is output to the viewfinder/LCD panel when recording using the following functions, even when set to [EXTERNAL OUTPUT].
 - Slow & Quick Motion (S&Q) recording
 - Recording to media and streaming distribution during live streaming
- The [QFHD REC OUTPUT] settings are enabled only when [FILE FORMAT] is set to [XAVC QFHD] in the REC/OUT SET menu.
- Any one of the following functions can be used when recording in XAVC QFHD.
 - External output while recording
 - Face detection function
 - Proxy recording (however, not supported when all the conditions below are met)
 - When REC/OUT SET → [REC SET] → [REC FORMAT] is set to 100Mbps
 - When REC/OUT SET → [REC SET] → [SIMUL/RELAY REC] is not set to [OFF]
- On the PXW-FS5, this function is supported using Ver. 1.1 or later (see page 5).

Protecting recorded movies (Protect)

You can protect movies to avoid deleting them by mistake.

1 Press the MENU button when the thumbnail screen is displayed.



2 Select  (EDIT) → [PROTECT] with the SEL/SET dial.

3 Select the movies to protect.

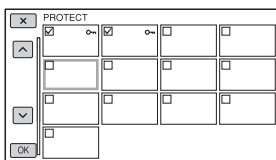
✓ is displayed on the selected image.



- Press the DISPLAY button to preview the image. Press  to return to the selection screen.
- You can select up to 100 images at one time.

4 Select  →  → .

To undo the protection

Select a movie marked with ✓ in step 3. ✓ disappears.

Dividing a movie

You can divide a movie at a designated point (AVCHD only).

1 Press the MENU button while playing back movies.

2 Select  (EDIT) → [DIVIDE] with the SEL/SET dial.

3 Select  at the point where you want to divide.

After you select the point with , make fine adjustment with these buttons.

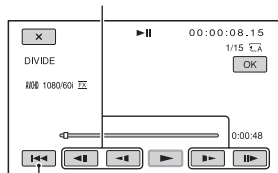

Returns to the beginning of the selected movie.

4 Select  → .

Notes

- You cannot restore movies once they are divided.
- Do not remove the battery pack, the AC Adapter or the memory card that contains the movies from your camcorder during the operation. It may damage the memory card.
- A slight difference may occur from the point where you touch  and the actual dividing point, as your camcorder selects the dividing point based in about half-second increments.
- You cannot divide a protected movie. Undo the protection of the movie to divide it, before you try to divide it (p. 134).

Deleting movies

- Movies recorded in XAVC HD cannot be divided.

💡 Tip

- Only simple editing is available on this camcorder. Use commercially available editing software for more advanced editing.

You can free media space by deleting movies from the memory card.

🔗 Notes

- You cannot restore images once they are deleted.
- Do not remove the battery pack, the AC Adapter or the memory card that contains the movies from your camcorder during the operation. It may damage the memory card.
- You cannot delete protected movies. Undo the protection of the movies, before you try to delete them (p. 134).
- Save important movies beforehand.

💡 Tip

- To delete all data recorded on the memory card and recover all the recordable space of the media, format the media (p. 136).



1 Press the MENU button when the thumbnail screen is displayed.

2 Select  (EDIT) → [DELETE] with the SEL/SET dial.

3 Select the movie to delete.

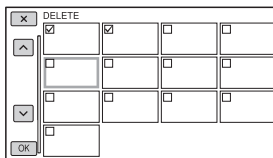
✓ is displayed on the selected image.



- Press the DISPLAY button to preview the image. Press  to return to the selection screen.
- You can select up to 100 images at one time.
-  appears at the upper right corner on the thumbnail of protected images.
- No checkbox appears on the thumbnail of protected images.

4 Select **OK** → **OK** → **OK**.

Formatting a memory card

Formatting deletes all data from the memory card to recover recordable free space.

Notes

- Connect your camcorder to the wall outlet (wall socket) using the supplied AC Adapter to prevent your camcorder from running out of power during the operation.
- To avoid the loss of important images, you should save them before formatting the media.
- Protected movies are also deleted.

1 Press the **MENU** button.

2 Select  (**SYSTEM**) → **[MEDIA FORMAT]** with the **SEL/SET** dial.

3 Select the memory card to format.

4 Select **OK** → **OK**.

Note

- While [Executing...] is displayed, do not operate the buttons on the camcorder, disconnect the AC Adapter, or remove the memory card from your camcorder (memory card access lamp is on or flashing during formatting).

Preventing data on a memory card from being recovered

Unintelligible data can be written on a memory card, making it difficult to recover any original data. It is impossible to delete all data completely, even if you format the memory card. Therefore, when you dispose of or transfer the memory card, it is recommended that you use the following procedure to erase the media.

⚙ Notes

- If you perform this operation, all stored data is deleted. To avoid the loss of important images, you should save them before formatting the media.
- You cannot perform this operation unless you connect the AC Adapter to the wall outlet (wall socket).
- Disconnect all cables except the AC Adapter. Do not disconnect the AC Adapter during the operation.
- Do not apply any vibrations or shocks to your camcorder during this operation.

1 Connect the AC Adapter and the power cord (mains lead) to the DC IN jack of your camcorder and the wall outlet (wall socket) (p. 22).

2 Press the MENU button.

3 Select  (SYSTEM) → [MEDIA FORMAT] with the SEL/SET dial.

4 Select the memory card to format.
The format screen appears.

5 Select [Empty] → .

⚙ Notes

- It may take from several minutes to several hours to erase data, depending on the capacity. You can check the actual time required on the LCD screen.
- If you stop the operation while [Executing...] is displayed, be sure to complete the operation by performing [MEDIA FORMAT] or emptying before you use the memory card again.

Repairing the image database file

This function checks the database information and the consistency of movies on a memory card, and repairs any inconsistencies found.

Note

- Connect your camcorder to the wall outlet (wall socket) using the supplied AC Adapter to prevent your camcorder from running out of power during the operation.

1 Press the MENU button.

2 Select  (SYSTEM) → [REPAIR IMAGE DB FILE] with the SEL/SET dial.

3 Select the memory card for which you want to check the database file.

4 Select .

The database file check starts. Select  and quit the database file check if no inconsistency is found.

5 Select  → .

Note

- If you stop the operation while [Repairing the image database file.] is displayed, be sure to complete the operation as described above before you use the memory card again.

Operating the menu

You can change various settings or make detailed adjustments using the menu items displayed on the LCD screen.

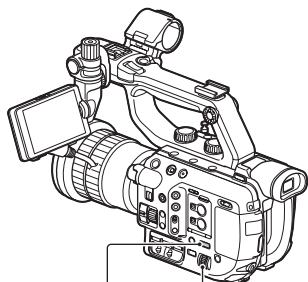

MENU button

SEL/SET dial

1 Press the MENU button.

The menu screen appears.

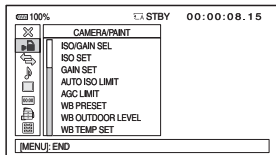

2 Turn the SEL/SET dial until the icon of the desired menu is highlighted, then press the dial to select the menu.

- CAMERA/PAINT (p. 147)
- REC/OUT SET (p. 153)
- AUDIO SET (p. 155)
- DISPLAY SET (p. 158)
- TC/UB SET (p. 162)
- NETWORK SET (p. 163)
- SYSTEM (p. 164)
- EDIT (p. 146)

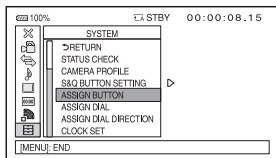

3 Turn the SEL/SET dial until the desired menu item is highlighted, then press the dial to select the item.

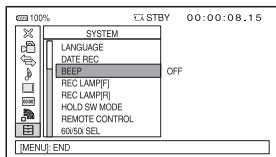

4 Turn the SEL/SET dial until the desired setting is highlighted, then press the dial to confirm the setting.

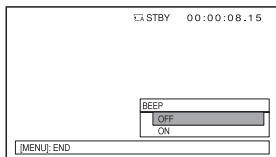

5 Press the MENU button to hide the menu screen.

To return to the previous screen, select [RETURN].

Notes

- The available menu items vary depending on the context of your camcorder during recording or playback.

Operating the menu (continued)

- Items and setting values not available due to other settings are grayed out.

Menu items

The function and setting value of each menu item are as follows.
The default settings are marked with ►.



(CAMERA/PAINT)

(p. 147)

ISO/GAIN SEL	►ISO, GAIN
ISO SET	H ISO800 to ISO32000 ^{*1} (►ISO3200) M ISO800 to ISO32000 ^{*1} (►ISO1600) L ISO800 to ISO32000 ^{*1} (►ISO800)
GAIN SET	H 0dB to 33dB (►18dB) M 0dB to 33dB (►9dB) L 0dB to 33dB (►0dB)
AUTO ISO LIMIT	►OFF, ISO800 to ISO25600 ^{*1}
AGC LIMIT	►OFF, 0dB to 30dB
WB PRESET	►OUTDOOR, INDOOR, MANU WB TEMP
WB OUTDOOR LEVEL	-7 to +7 (►0)
WB TEMP SET	2300K to 15000K (►6500K)
BLACK BALANCE	
AE SHIFT	ON/OFF ►OFF, ON LEVEL -2.0EV to +2.0EV (►0EV)
LENS COMPENSATION	►AUTO, OFF

ND FILTER	PRESET1 ►1/4, 1/8, 1/16, 1/32, 1/64, 1/128 PRESET2 1/4, 1/8, ►1/16, 1/32, 1/64, 1/128 PRESET3 1/4, 1/8, 1/16, 1/32, ►1/64, 1/128
ND/IRIS DIAL DIRECTION	►NORMAL, OPPOSITE
CENTER SCAN	►OFF, ON
ZOOM SET	ZOOM TYPE ►OPTICAL ZOOM ONLY, ON[CLEAR IMAGE ZOOM] HANDLE ZOOM ZOOM SPEED TYPE ►VARIABLE, FIXED, OFF ZOOM SPEED 1 to 8 (►3) ZOOM RING ROTATE ►LEFT(W)/ RIGHT(T), RIGHT(W)/LEFT(T)
STEADYSHOT	►STANDARD, ACTIVE, OFF

Menu items (continued)

SLOW & QUICK

S&Q MOTION

HIGH FRAME RATE

▶OFF, ON

REC FORMAT

When [60i] is

selected:

XAVC QFHD

2160/30p 100Mbps^{*2}

▶2160/30p 60Mbps^{*2}

2160/24p 100Mbps^{*3}

▶2160/24p 60Mbps^{*3}

XAVC HD

1080/60p 50Mbps

1080/60p 35Mbps

1080/30p 50Mbps

1080/30p 35Mbps

▶1080/24p 50Mbps

1080/24p 35Mbps

AVCHD

1080/60p PS

1080/30p FX

1080/30p FH

▶1080/24p FX

1080/24p FH

When [50i] is

selected:

XAVC QFHD

2160/25p 100Mbps

▶2160/25p 60Mbps

XAVC HD

1080/50p 50Mbps

1080/50p 35Mbps

▶1080/25p 50Mbps

1080/25p 35Mbps

AVCHD

1080/50p PS

▶1080/25p FX

1080/25p FH

FRAME RATE

When [60i] is

selected:

XAVC QFHD

1fps to 30fps

(▶30fps)

XAVC HD/AVCHD

1fps to 60fps

(▶60fps)

When [50i] is
selected:

XAVC QFHD

1fps to 25fps

(▶25fps)

XAVC HD/AVCHD

1fps to 50fps

(▶50fps)

SUPER SLOW

MOTION

REC FORMAT

When [60i] is

selected:

XAVC HD

1080/60p 50Mbps

1080/60p 35Mbps

1080/30p 50Mbps

1080/30p 35Mbps

▶1080/24p 50Mbps

1080/24p 35Mbps

AVCHD

1080/60p PS

1080/30p FX

1080/30p FH

▶1080/24p FX

1080/24p FH

When [50i] is

selected:

XAVC HD

1080/50p 50Mbps

1080/50p 35Mbps

▶1080/25p 50Mbps

1080/25p 35Mbps

AVCHD

1080/50p PS

▶1080/25p FX

1080/25p FH

FRAME RATE

When [60i] is

selected:

120fps to 960fps

(▶120fps)

When [50i] is

selected:

100fps to 800fps

(▶100fps)

REC TIMING
 START TRIGGER,
 ►END TRIGGER,
 END TRIGGER
 HALF

 4K SUPER
 SLOW



See page 72.

 2K SUPER
 SLOW

See page 72.

AUTO BACK LIGHT	►OFF, ON
FACE DETECTION	►OFF, ON
VIDEO LIGHT	►POWER LINK, REC LINK, REC LINK+STBY, AUTO
AF MICRO ADJUSTMENT	ON/OFF ►OFF, ON AMOUNT -20 to +20 (►0) CLEAR ALL
COLOR BAR	ON/OFF ►OFF, ON TONE ►OFF, ON
PICTURE PROFILE	See page 103.

(REC/OUT SET) (p. 153)

REC SET	FILE FORMAT XAVC QFHD ►XAVC HD AVCHD  & XAVC HD 
	REC FORMAT XAVC QFHD When [60i] is selected: 2160/30p 100Mbps ►2160/30p 60Mbps 2160/24p 100Mbps 2160/24p 60Mbps When [50i] is selected: 2160/25p 100Mbps ►2160/25p 60Mbps

XAVC HD

When [60i] is
selected:
1080/60p 50Mbps
1080/60p 35Mbps
►1080/60i 50Mbps
1080/60i 35Mbps
1080/60i 25Mbps
1080/30p 50Mbps
1080/30p 35Mbps
1080/24p 50Mbps
1080/24p 35Mbps
720/60p 50Mbps

When [50i] is
selected:
1080/50p 50Mbps
1080/50p 35Mbps
►1080/50i 50Mbps
1080/50i 35Mbps
1080/50i 25Mbps
1080/25p 50Mbps
1080/25p 35Mbps
720/50p 50Mbps

AVCHD

When [60i] is
selected:
1080/60p PS
►1080/60i FX
1080/60i FH
1080/30p FX
1080/30p FH
1080/24p FX
1080/24p FH
720/60p FX
720/60p FH
720/60p HQ

When [50i] is
selected:
1080/50p PS
►1080/50i FX
1080/50i FH
1080/25p FX
1080/25p FH
720/50p FX
720/50p FH
720/50p HQ

SIMUL/RELAY REC
 ►OFF,
 SIMULTANEOUS
 REC, RELAY REC

Menu items (continued)

REC BUTTON SETTING

See page 42.

OUTPUT FORMAT

See page 71.

PROXY REC MODE ON/OFF

▶OFF, ON

SIZE

▶1280×720,
640×360

VIDEO OUT

OUTPUT SELECT

OUTPUT SELECT
SDI, ▶HDMI,
VIDEO

QFHD REC OUTPUT

▶VF/LCD PANEL,
EXTERNAL
OUTPUT

SDI/HDMI

When [60i] is
selected:
2160p/1080p/480i,
2160p/720p/480i,
2160p/1080i/480i
1080p/480i,
720p/480i,

▶1080i/480i,
480p, 480i

When [50i] is
selected:

2160p/1080p/576i,
2160p/720p/576i,
2160p/1080i/576i
1080p/576i,
720p/576i,
▶1080i/576i, 576p,
576i

24p/30p OUTPUT^{*4}

▶24p/30p,
24PsF/30PsF,
60p(Pull Down)

25p OUTPUT^{*5}

▶25p, 25PsF,
50p(Pull Down)

DOWN CONVERT TYPE

▶SQUEEZE,
LETTER BOX(16:9),
EDGE CROP

HDMI TC OUTPUT

▶OFF, ON

SDI/HDMI REC CONTROL

▶OFF, ON

(AUDIO SET) (p. 155)

VOLUME

AVCHD AUDIO ▶LINEAR PCM,
FORMAT DOLBY DIGITAL

CH1 INPUT SELECT ▶INT MIC, INPUT1, MI
SHOE MIC

CH2 INPUT SELECT ▶INT MIC, INPUT1,
INPUT2, MI SHOE MIC

AUDIO LIMIT ▶OFF, ON

HEADPHONE OUT ▶STEREO, MIX
MONO, CH1, CH2

INT MIC SET INT MIC SENS
▶NORMAL, HIGH

INT MIC WIND
▶OFF, ON

XLR SET XLR AGC LINK
▶SEPARATE,
LINKED

INPUT1 TRIM
-18dB to +12dB
(▶0dB)

INPUT1 WIND
▶OFF, ON

INPUT2 TRIM
-18dB to +12dB
(▶0dB)

INPUT2 WIND
▶OFF, ON

(DISPLAY SET) (p. 158)

HISTOGRAM	▶OFF, ON, ON[ZEBRA POINT]
ZEBRA	ZEBRA SELECT ▶OFF, ZEBRA1, ZEBRA2 ZEBRA1 LEVEL 0% to 109% (▶70%) ZEBRA1 APERTURE LEVEL 2% to 20% (▶10%) ZEBRA2 LEVEL 0% to 109% (▶100%)
PEAKING	ON/OFF ▶OFF, ON COLOR ▶WHITE, RED, YELLOW LEVEL HIGH, ▶MIDDLE, LOW
MARKER	ON/OFF ▶OFF, ON CENTER ▶ON, OFF ASPECT ▶OFF, 4:3, 13:9, 14:9, 15:9, 1.66:1, 1.85:1, 2.35:1 SAFETY ZONE ▶OFF, 80%, 90% GUIDEFAME ▶OFF, ON
FOCUS MAG RATIO	×4.0, ×8.0, ▶×4.0/×8.0
CAMERA DATA DISPLAY	OFF, ▶ON
AUDIO LEVEL DISPLAY	▶ON, OFF
ZOOM DISPLAY	▶BAR, NUMBER
FOCUS DISPLAY	▶METER, FEET
SHUTTER DISPLAY	▶SECOND, DEGREE
DATA CODE	▶OFF, DATE/TIME, CAMERA DATA

GAMMA DISP ASSIST	ON/OFF ▶ON, OFF TYPE ▶AUTO, S-LOG2→ 709(800%), S-LOG3 →709(800%) HLG(BT.2020) HLG(709)
LCD BRIGHT	▶NORMAL, BRIGHT
VF COLOR TEMP.	
VF/LCD PANEL	▶LCD PANEL, AUTO
DISPLAY OUTPUT	▶LCD PANEL, ALL OUTPUT





(TC/UB SET) (p. 162)

TC/UB DISPLAY	▶TC, U-BIT
TC PRESET	PRESET RESET
UB PRESET	PRESET RESET
TC FORMAT ²	▶DF, NDF
TC RUN	▶REC RUN, FREE RUN
TC MAKE	▶PRESET, REGENERATE
UB TIME REC	▶OFF, ON

(NETWORK SET) (p. 163)

CTRL W/ SMARTPHONE	
STREAMING	PRESET SELECT ▶PRESET1, PRESET2, PRESET3 PRESET1/PRESET2/ PRESET3 SIZE ▶640×360, 1280×720 DESTINATION SET

Menu items (continued)

FTP TRANSFER	FTP SERVER SELECT ▶FTP SERVER1, FTP SERVER2, FTP SERVER3 FTP SERVER1/FTP SERVER2/FTP SERVER3 DISPLAY NAME DESTINATION SET USER INFO SET FTP RESULT
WIRED LAN SET	IP ADDRESS SET
WI-FI SET	ACCESS POINT SET WPS EDIT DEVICE NAME SSID/PW RESET DISP MAC ADDRESS
AIRPLANE MODE	▶OFF, ON
ROOT	
CERTIFICATE	
NETWORK RESET	
 (SYSTEM) (p. 164)	
STATUS CHECK	
CAMERA PROFILE	MEMORY CARD A/ MEMORY CARD B LOAD SAVE DELETE
S&Q BUTTON SETTING	▶S&Q/SUPER SLOW, S&Q MOTION, SUPER SLOW MOTION
 S&Q BUTTON SET	▶  4K/2K SUPER SLOW,  4K SUPER SLOW,  2K SUPER SLOW
ASSIGN BUTTON	ASSIGN1, ASSIGN2, ASSIGN3, ASSIGN4, ASSIGN5, ASSIGN6
ASSIGN DIAL	----, ▶IRIS, ND FILTER, ISO/GAIN, AE SHIFT, FOCUS
ASSIGN DIAL DIRECTION	▶NORMAL, OPPOSITE
CLOCK SET	
AREA SET	

SUMMERTIME	▶OFF, ON
LANGUAGE	
GPS SETTING	▶ON, OFF
GPS INFORMATION –	
AUTO CLOCK ADJ	▶ON, OFF
AUTO AREA ADJ	▶ON, OFF
DATE REC	▶OFF, ON
BEEP	▶OFF, ON
REC LAMP[F]	▶ON, OFF
REC LAMP[R]	▶ON, OFF
HOLD SW SET	W/REC BUTTON ON, ▶OFF W/GRIP REMOTE ▶ON, OFF
REMOTE CONTROL	▶ON, OFF
60i/50i SEL	
MEDIA FORMAT	MEMORY CARD A MEMORY CARD B
REPAIR IMAGE DB FILE	MEMORY CARD A MEMORY CARD B
USB CONNECT	
USB LUN SET	▶MULTI, SINGLE
OPERATION TIME	
OPTION	HIGH FRAME RATE MPEG HD RAW INSTALL OPTION ID
VERSION DISPLAY	
INITIALIZE	
 (EDIT)	
PROTECT	
DIVIDE	
DELETE	
*1 Setting range when picture profile is set to [OFF].	
*2 When 2160/30p is selected.	
*3 When 2160/24p is selected.	
*4 Available only when [60i/50i SEL] is set to [60i].	
*5 Available only when [60i/50i SEL] is set to [50i].	

(CAMERA/PAINT) menu

Tips

- You can assign this function to an ASSIGN button (p. 85).
- You can display the [EDIT] menu by pressing the MENU button when the thumbnail or playback screen is displayed.

Settings to adjust your camcorder to the recording conditions (GAIN SET/ STEADYSHOT, etc.)

The default settings are marked with ►. See page 139 for details on selecting menu items.

Press the MENU button → select  (CAMERA/PAINT) with the SEL/SET dial.

ISO/GAIN SEL

You can switch the ISO sensitivity/gain indicator.

► ISO

Displays the ISO sensitivity.

GAIN

Displays the gain (dB).

Notes

- Note that ISO sensitivity and gain are separately saved with different values.
- [ISO/GAIN SEL] is available only when the FULL AUTO button is off (not lit).

* On the PXW-FS5, the following ISO/GAIN settings are applicable using Ver. 4.0 or later (see page 5).

ISO SET

You can set ISO values for the positions of the ISO/GAIN L/M/H switch.

Default setting:

[L]: ISO800, [M]: ISO1600,
[H]: ISO3200

- ① Select CAMERA/PAINT → ISO SET → L, M, or H with the SEL/SET dial.
- ② Set the ISO sensitivity value with the SEL/SET dial, then press the dial. You can select a value between ISO800 and ISO3200 in 1/3EV increments.

(CAMERA/PAINT) menu (continued)

The larger the value, the higher the ISO sensitivity.

- ③ Select [OK] with the SEL/SET dial.

Setting value

The value you can set depends on the [GAMMA] setting of the picture profile.

- STANDARD: ISO800 to ISO32000
- STILL: ISO640 to ISO25600
- CINE1: ISO640 to ISO25600
- CINE2: ISO500 to ISO20000
- CINE3: ISO800 to ISO32000
- CINE4: ISO800 to ISO32000
- ITU709: ISO800 to ISO32000
- ITU709(800%): ISO2000 to ISO102400
- S-LOG2: ISO2000 to ISO102400
- S-LOG3: ISO2000 to ISO102400
- HLG: ISO800 to ISO32000
- HLG1: ISO400 to ISO16000
- HLG2: ISO640 to ISO25600
- HLG3: ISO800 to ISO32000

💡 Tips

- Available when [ISO/GAIN SEL] is set to [ISO].
- The value can be set separately from the one set in [GAIN SET].

GAIN SET

You can set gain values for H, M and L positions of the ISO/GAIN switch.

Default setting:

[L]: 0dB, [M]: 9dB, [H]: 18dB

- ① Select CAMERA/PAINT → GAIN SET → L, M, or H with the SEL/SET dial.
- ② Set the gain value with the SEL/SET dial, then press the dial.
You can select a value between 0dB and 33dB in 3dB increments. The larger the value, the higher the gain.
- ③ Select [OK] with the SEL/SET dial.

💡 Tips

- Available when [ISO/GAIN SEL] is set to [GAIN].
- The value can be set separately from the one set in [ISO SET].

AUTO ISO LIMIT

You can select the upper limit for auto ISO adjustment.

Default setting:

▶ **OFF, ISO800 to ISO25600**
(1/3EV increments)

Setting value

The value you can set depends on the [GAMMA] setting of the picture profile.

- STANDARD: ISO800 to ISO25600
- STILL: ISO640 to ISO20000
- CINE1: ISO640 to ISO20000
- CINE2: ISO500 to ISO16000
- CINE3: ISO800 to ISO25600
- CINE4: ISO800 to ISO25600
- ITU709: ISO800 to ISO25600
- ITU709(800%): ISO2000 to ISO80000
- S-LOG2: ISO2000 to ISO80000
- S-LOG3: ISO2000 to ISO80000
- HLG: ISO800 to ISO25600
- HLG1: ISO400 to ISO12800
- HLG2: ISO640 to ISO20000
- HLG3: ISO800 to ISO25600

🔒 Note

- This function is not active when you adjust the ISO sensitivity manually.

💡 Tips

- Available when [ISO/GAIN SEL] is set to [ISO].
- The value can be set separately from the one set in [AGC LIMIT].

AGC LIMIT

You can select the upper limit for the Auto Gain Control (AGC).

▶OFF, 30dB to 0dB (3dB increments)

Note

- This function is not active while you adjust the gain manually.

Tips

- Available when [ISO/GAIN SEL] is set to [GAIN].
- The value can be set separately from the one set in [AUTO ISO LIMIT].

WB PRESET

You can use the preset white balance. For details, see page 55.

Note

- Cannot be selected when [COLOR MODE] in the picture profile is set to the following.

S-GAMUT/xxxxK, S-GAMUT3.CINE/xxxxK, or S-GAMUT3/xxxxK

The white balance color temperature is fixed to xxxxK when any of the color modes above is selected.

WB OUTDOOR LEVEL

You can set an offset value to adjust the outdoor white balance when you set [WB PRESET] to [OUTDOOR].

-7 to ▶0 to +7
(bluish to normal to reddish)

Note

- Cannot be selected when [COLOR MODE] in the picture profile is set to the following.

S-GAMUT/xxxxK, S-GAMUT3.CINE/xxxxK, or S-GAMUT3/xxxxK

The white balance color temperature is fixed to xxxxK when any of the color modes above is selected.

WB TEMP SET

You can set the color temperature when you set [WB PRESET] to [MANU WB TEMP].

2300K to ▶6500K to 15000K (100K increments)

Note

- Cannot be selected when [COLOR MODE] in the picture profile is set to the following.

S-GAMUT/xxxxK, S-GAMUT3.CINE/xxxxK, or S-GAMUT3/xxxxK

The white balance color temperature is fixed to xxxxK when any of the color modes above is selected.

BLACK BALANCE

See page 56.

AE SHIFT

■ ON/OFF

▶ OFF

Does not use the AE SHIFT function.

ON

Uses the AE SHIFT function. The selected value (-2.0EV for example) appears on the LCD screen.

■ LEVEL

You can adjust the brightness with the SEL/SET dial.

-2.0EV to ▶0EV to +2.0EV (1/4EV increments)
(dark to standard to bright)

Note

- This function is not available while you adjust the iris, shutter speed, and ISO sensitivity/gain manually.

Tips

- You can assign [ON/OFF] to an ASSIGN button (p. 85).
- Can be operated using Direct Menu.
- You can assign the LEVEL adjustment to the ASSIGN dial (p. 85).

(CAMERA/PAINT) menu (continued)

LENS COMPENSATION

Enable/disable the lens compensation function.

► AUTO

Use the lens compensation function.

OFF

Do not use the lens compensation function.

ND FILTER

Set the preset value of the ND filter.

■ PRESET1

►1/4, 1/8, 1/16, 1/32, 1/64, 1/128

■ PRESET2

1/4, 1/8, ►1/16, 1/32, 1/64, 1/128

■ PRESET3

1/4, 1/8, 1/16, 1/32, ►1/64, 1/128

ND/IRIS DIAL DIRECTION

Select the operation direction of the dial beside the ND/IRIS switch.

► NORMAL

Rotating upward makes the picture brighter. When assigned to the grip ASSIGN dial, corresponds to rotating right.

OPPOSITE

Rotating downward makes the picture brighter. When assigned to the grip ASSIGN dial, corresponds to rotating left.

CENTER SCAN

You can record a cropped portion at the center of the image sensor. It provides the equivalent of a 2× optical zoom.

► OFF

Disable center scan.

ON (**C.SCAN**)

Enable center scan.

🔍 Note

- For details about usage restrictions, see “Function limitations when recording” (p. 180).

💡 Tip

- You can assign [ON/OFF] to an ASSIGN button (p. 85).

ZOOM SET

Sets the action when operating the zoom lever.

■ ZOOM TYPE

► OPTICAL ZOOM ONLY

Uses optical zoom only.

ON[CLEAR IMAGE ZOOM]

You can use the clear image zoom in addition to the optical zoom.

🔍 Note

- The face detection function is not available while using clear image zoom.

💡 Tip

- Clear image zoom maintains an image quality that is close to the original.

■ HANDLE ZOOM

Set the type of handle zoom.

ZOOM SPEED TYPE

► VARIABLE

Press the zoom lever slightly to zoom slowly, and press it further to zoom more quickly.

FIXED

Zoom at a fixed speed.

OFF

Do not use handle zoom.

ZOOM SPEED

1 to (►3) to 8

■ ZOOM RING ROTATE

Select the operation method of the zoom ring on the lens.

▶ LEFT(W)/RIGHT(T)

Turn the zoom ring clockwise, as viewed from the body, to more to the telephoto end.

RIGHT(W)/LEFT(T)

Turn the zoom ring counterclockwise, as viewed from the body, to more to the telephoto end.

🔊 Note

- This setting is available only when a lens that supports switching the direction of the zoom ring is attached. Cannot be used with lenses that do not support the switching function.

📷 STEADYSHOT

This setting is available only when a lens that supports SteadyShot image stabilization is attached.

▶ STANDARD (📷)

Uses SteadyShot under relatively stable conditions.

ACTIVE (📷)

Uses SteadyShot with more powerful stabilization effect.

OFF (📷)

Does not use SteadyShot.

This setting is recommended when you use a tripod.

🔊 Notes



- [ACTIVE] can be selected only when recording with a lens that supports active image stabilization.
- For lenses fitted with an image stabilization selector switch, the switch setting on the lens takes precedence. This menu cannot be selected if a lens fitted with an image stabilization selector switch is attached that does not support ACTIVE image stabilization. The image stabilization for such a lens is:
Lens switch on: STANDARD
Lens switch off: OFF

💡 Tip

- You can assign this function to an ASSIGN button (p. 85).

SLOW & QUICK

See page 63.

- For details about HIGH FRAME RATE, see page 68.
- For details about  4K SUPER SLOW, see page 72.
- For details about  2K SUPER SLOW, see page 72.

AUTO BACK LIGHT

You can automatically correct for backlighting.

▶ OFF

Does not correct for backlighting.

ON

Automatically corrects for backlighting.

FACE DETECTION

See page 47.

VIDEO LIGHT

This sets the lighting method for a video light attached to the multi-interface shoe.

▶ POWER LINK

Video light turns on/off when the camcorder power is turned on/off.

REC LINK

Video light turns on/off when the camcorder starts/stops recording.

REC LINK+STBY

Video light turns on or switches to standby when the camcorder starts/stops recording.

AUTO

Light turns on automatically.

(CAMERA/PAINT) menu (continued)

Note

When set to [REC LINK] and shooting in Super Slow Motion, video cannot be recorded while the video light is turned on. To turn on the video light and shoot in Super Slow Motion, set to [POWER LINK].

AF MICRO ADJUSTMENT

When you use the LA-EA2/LA-EA4 mount adapter (sold separately) and an A-mount lens, you can register a specific focal setting for that lens.

■ ON/OFF

▶ OFF

Deactivates AF micro adjustment.

ON

Activates AF micro adjustment.

■ AMOUNT

You can set the adjustment value of the attached lens.

Set a higher value to focus farther from the camcorder, or set a lower value to focus closer to the camcorder.

–20 to ▶0 to +20

■ CLEAR ALL

You can clear the values of all the registered lenses.

Notes

- When [AF MICRO ADJUSTMENT] is not set to [ON], you cannot register an adjustment value.
- We recommend that you decide the value under actual shooting conditions.
- When you attach a lens that is registered on the camcorder, the registered value is displayed. If the lens is unregistered, [±0] is displayed.
- If the number of registered lenses reaches 30, [AMOUNT] is grayed out and cannot be selected. To register any further lenses, you first need to delete already registered lenses. To do this, attach a lens to delete its registered value, then reset its value to [±0]. Alternatively, you can reset the values of all lenses with [CLEAR ALL].

- If you perform AF micro adjustment with the lens of another manufacturer, the adjustment values of Sony, Minolta, and Konica Minolta lenses may be affected. Do not use this function with lenses of any other manufacturer.
- You cannot perform individual AF micro adjustment for Sony, Minolta, or Konica Minolta lenses of the same specifications.

COLOR BAR

This function helps you to adjust colors when you view movies recorded with your camcorder on a TV or a monitor.

■ ON/OFF

▶ OFF

Does not display color bars.

ON

Displays color bars on the LCD screen, records them, and outputs audio tone signals.

Notes

- For details about usage restrictions, see “Function limitations when recording” (p. 180).
- This function is automatically set to [OFF] when you switch the format, perform the function by the MENU button, or turn off the camcorder.
- You cannot change the setting during recording or focus magnification operation.

■ TONE

▶ OFF

Does not output audio tone signals.

ON

Outputs audio tone signals (1 kHz: full bit –20dB (when [60i] is selected), –18dB (when [50i] is selected)).

Set [ON/OFF] to [ON], too.

Tips

- If you record color bars with [TONE] set to [OFF], the camcorder records sound from the microphone.
- You can assign [ON/OFF] to an ASSIGN button (p. 85).

PICTURE PROFILE

See page 103.

↔ (REC/OUT SET) menu

Recording settings, input and output settings (REC SET/VIDEO OUT)

The default settings are marked with ►.
See page 139 for details on selecting menu items.

Press the MENU button → select ↔ (REC/OUT SET) with the SEL/SET dial.

REC SET

■ FILE FORMAT

See page 48.

■ REC FORMAT

See page 48.

For details about RAW format recording, see page 71.

■ SIMUL/RELAY REC

See page 42.

■ REC BUTTON SETTING

See page 42.

■ PROXY REC MODE

See page 49.

VIDEO OUT

■ OUTPUT SELECT

You can select where to output images.

SDI

► HDMI

VIDEO

■ QFHD REC OUTPUT

See page 133.

(REC/OUT SET) menu (continued)

■ SDI/HDMI

You can select the resolution of the output signal from the SDI/HDMI jacks.

When [60i] is selected:

2160p/1080p/480i

2160p/720p/480i

2160p/1080i/480i

1080p/480i

720p/480i

▶ 1080i/480i

480p

480i

When [50i] is selected:

2160p/1080p/576i

2160p/720p/576i

2160p/1080i/576i

1080p/576i

720p/576i

▶ 1080i/576i

576p

576i

💡 Tip

- See page 125 for the resolution of the output signal for each type of connecting cable.

■ 24p/30p OUTPUT (when [60i] is selected)

Sets the output format when the frame rate in [REC FORMAT] is set to 24p and progressive scan method is selected.

▶ 24p/30p

24PsF/30PsF

60p(Pull Down)

🔔 Note

- This function is available only when SDI/HDMI is 1080p/480i.

■ 25p OUTPUT (when [50i] is selected)

Sets the output format when the frame rate in [REC FORMAT] is set to 25p and progressive scan method is selected.

▶ 25p

25PsF

50p(Pull Down)

🔔 Note

- This function is available only when SDI/HDMI is 1080p/576i.

■ DOWN CONVERT TYPE

You can set the output format of the video signal.

Selects the shape of the output 4:3 image at 480p/480i or 576p/576i.

▶ SQUEEZE

Outputs a horizontally compressed image while maintaining its original height.

LETTER BOX(16:9)

Outputs a vertically compressed image, with black bands across top and bottom, while maintaining its original aspect ratio.

EDGE CROP

Outputs the central portion of the original image by cropping its right and left edges.

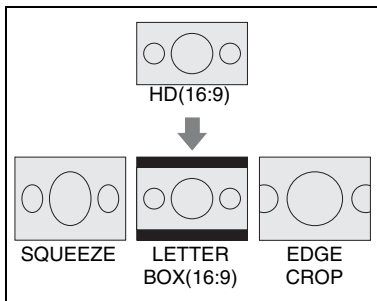

HDMI TC OUTPUT

You can set whether to output time code to other professional-use devices, using HDMI.

▶ OFF

Does not overlay the time code information on the HDMI output signal.

ON

Overlays the time code information on the HDMI output signal.

The data is transmitted as digital data, not as a projected image, and the connected device identifies the time data by referencing the transmitted digital data.

SDI/HDMI REC CONTROL

When the camcorder is connected to an external recorder that supports this function, you can set whether the external recorder automatically starts/stops recording in sync with the camcorder.

▶ OFF

Does not record in sync with the camcorder.

ON

Records to an external recorder in sync with the camcorder.

🎵 (AUDIO SET) menu**Settings for audio recording (AVCHD AUDIO FORMAT/XLR SET, etc.)**

The default settings are marked with ▶. See page 139 for details on selecting menu items.

Press the MENU button → select 🎵 (AUDIO SET) with the SEL/SET dial.

VOLUME

Turn the SEL/SET dial to adjust the volume.

💡 Tip

- You can assign this function to an ASSIGN button (p. 85).

AVCHD AUDIO FORMAT

You can set the audio format for AVCHD recording.

▶ LINEAR PCM (🎵LPCM)

Records in Linear PCM system.

DOLBY DIGITAL (🎵DolbyD)

Records in Dolby Digital system.

CH1 INPUT SELECT

Sets the CH-1 audio source.

▶ INT MIC

Internal microphone.

INPUT1

Input to INPUT 1 jack.

MI SHOE MIC

Microphone attached to Multi Interface Shoe.

(AUDIO SET) menu (continued)

CH2 INPUT SELECT

Sets the CH-2 audio source.

▶ INT MIC

Internal microphone.

INPUT1

Input to INPUT 1 jack.

INPUT2

Input to INPUT 2 jack.

MI SHOE MIC

Microphone attached to Multi Interface Shoe.

AUDIO LIMIT

You can set the clipping-noise reduction function for CH-1/CH-2.

▶ OFF

Disables the function.

ON

Enables the function.

🔊 Note

- This function is available only when you set the AUTO/MAN (CH-1/CH-2) switches to "MAN."

HEADPHONE OUT

See page 84.

INT MIC SET

■ INT MIC SENS

You can set the audio recording sensitivity of the internal microphone.

▶ NORMAL

Sensitivity generally used for professional-use devices.

HIGH (SENS-HI)

Sensitivity generally used for consumer-use devices.

(SENS-HI) appears on the status check screen.

■ INT MIC WIND

You can attenuate low tone input sound in the internal microphone to reduce wind noise.

▶ OFF

Disables wind noise reduction.

ON (🔊)

Enables wind noise reduction.

(🔊) appears on the status check screen.

🔊 Note

- If the internal microphone is selected for both CH-1 and CH-2 (CH-1: INT MIC, CH-2: INT MIC), the sound that is output from the headphones during recording and standby will have weaker stereo effect than the sound that is actually recorded.

XLR SET

■ XLR AGC LINK

You can select either linked or separate AGC (Auto Gain Control) of CH-1 and CH-2 when using an external microphone.

▶ SEPARATE

Separately applies the AGC for channels 1 and 2. Sound inputs from channels 1 and 2 will be recorded separately.

LINKED (🔊A₁2)

Links AGC (channels 1 and 2 are recorded with linked AGC, like stereo).

A appears on the status check screen.

🔊 Note

- Enabled when the AUTO/MAN switches for both CH-1 and CH-2 are set to "AUTO," and LINE, MIC, or MIC+48V is selected on the INPUT 1/INPUT 2 switches for both channels (p. 82).

■ INPUT1 TRIM

You can adjust the input signal level from the INPUT 1 jack.

-18dB, -12dB, -6dB, ►0dB, +6dB, +12dB

🔊 Note

- The setting is not available when you set the INPUT 1 switch to “LINE.”

■ INPUT1 WIND

► OFF

Disables the wind noise reduction function for the INPUT 1 jack.

ON (📧)

Activates the wind noise reduction function for the INPUT 1 jack.

📧 appears on the status check screen.

🔊 Note

- The setting is not available when you set the INPUT 1 switch to “LINE.”

■ INPUT2 TRIM

■ INPUT2 WIND

See the description for the corresponding functions for INPUT1.

💡 Tips

- If the recording level is set to “AUTO” and INPUT TRIM is set to [0dB], a -48 dBu input will be recorded at the reference recording level (-48 dBu corresponds to 0 dB level). For example, if a microphone with -30 dB sensitivity (0 dB = 1 V/Pa at 1 kHz) is connected and a 1 kHz 74 dB SPL sound pressure level is input (microphone output is -48 dBu), set INPUT TRIM to [0dB]. If using a microphone with -36 dB sensitivity, setting INPUT TRIM to [+6dB] will compensate for the difference in sensitivity from a microphone with -30 dB sensitivity.
- The INPUT TRIM function adjusts the input level from an external microphone. For microphones with high sensitivity or to record high-level audio, adjust in the negative direction. For microphones with low sensitivity or to record low-level audio, adjust in the positive direction.

- Distortion of high-volume audio may occur in the input stage or the recording stage. To counter distortion of the input stage, adjust the level using the INPUT TRIM function. To counter distortion in the recording stage, reduce the overall level manually.
- If the INPUT TRIM is adjusted in the negative direction too far, the audio level from the microphone may become too small, adversely affecting the S/N ratio.
- Test the effect of using [XLR SET] beforehand to suit the microphone used and the sound field to record.

■ (DISPLAY SET) menu

Display settings (MARKER/DISPLAY OUTPUT, etc.)

The default settings are marked with ►.
See page 139 for details on selecting menu items.

Press the MENU button → select  (DISPLAY SET) with the SEL/SET dial.

HISTOGRAM

The histogram displays the luminance distribution that shows how many pixels of a particular brightness exist in the image.

► OFF

Does not display the histogram.

ON

Displays a histogram.

A line appears at the 100% position, and the color of the zone above the line changes.

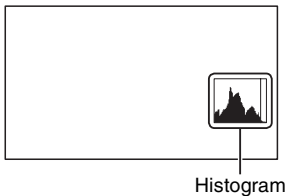

ON[ZEBRA POINT]

The histogram shows the point where the zebra pattern appears. A line is displayed at the brightness level set with [ZEBRA].

Note

- Cannot be displayed when Super Slow Motion mode is set.

Tip

- You can assign this function to an ASSIGN button (p. 85).

ZEBRA

See page 54.

PEAKING

■ ON/OFF

► OFF

Does not display the peaking.

ON (PEAKING)

You can display an image on the LCD screen with its outlines enhanced.

This function helps you to adjust the focus.

■ COLOR

You can select peaking color.

► WHITE, RED, YELLOW

■ LEVEL

You can select the peaking sensitivity.

HIGH, ► MIDDLE, LOW

Note

- The enhanced outlines will not be recorded on the memory card.

Tips

- You can focus more easily using this function in combination with the focus magnifier function (p. 46).
- You can assign [ON/OFF] to an ASSIGN button (p. 85).

MARKER

■ ON/OFF

► OFF

Does not display markers.

ON

Displays markers.

■ CENTER

OFF

Does not display a center maker.

► ON

Displays a marker at the center of the LCD screen.



■ ASPECT

▶ OFF

Does not display the aspect ratio.

4:3, 13:9, 14:9, 15:9, 1.66:1, 1.85:1, 2.35:1

Displays markers at boundaries of display area defined by the aspect ratio.



■ SAFETY ZONE

▶ OFF

Does not display the safety zone.

80%, 90%

If you select 80% or 90%, you can display markers at boundaries of the display area that regular home TVs can display.



■ GUIDEFAME

▶ OFF

Does not display the guideframe.

ON

Displays the guideframe.

You can check the horizontal and vertical aspect of a subject.



⚡ Notes

- Markers are not recorded onto the memory card.
- Only the time code, zebra, peaking, and face detection frames are output when marker display is on, even if [DISPLAY OUTPUT] is set to [ALL OUTPUT].
- Markers cannot be displayed during [FOCUS MAGNIFIER] operation.

- The marker display cannot be output to an external device.

💡 Tips

- You can display all types of markers at the same time.
- You can obtain a balanced composition by positioning the subject at the cross points of the guideframe marker.
- You can assign [ON/OFF] to an ASSIGN button (p. 85).

FOCUS MAG RATIO

You can set the magnification of the focus.

×4.0

×8.0

▶ ×4.0/×8.0

The setting changes in the order [×4.0] → [×8.0] → Off with each press of the FOCUS MAG button.

CAMERA DATA DISPLAY

OFF

Does not display the iris, ISO sensitivity/gain, and shutter speed settings.

▶ ON

Constantly displays the iris, ISO sensitivity/gain, and shutter speed settings.

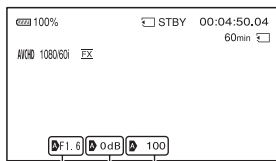

Iris value

Shutter speed value

ISO sensitivity/gain

💡 Tips

- You can assign this function to an ASSIGN button (p. 85).

(DISPLAY SET) menu (continued)

- The settings appear on the LCD screen during the manual adjustment regardless of the settings of this function.
- **A** indicates that the settings are automatically adjusted values.
- The displayed settings vary when you press a button assigned with the DATA CODE function (p. 122).

AUDIO LEVEL DISPLAY

► ON

Displays the audio level meters on the LCD screen.

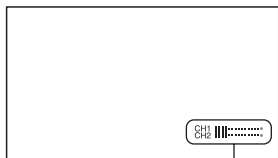

Audio level meters

OFF

Does not display the audio level meters.

💡 Tip

- You can assign this function to an ASSIGN button (p. 85).

ZOOM DISPLAY

► BAR

Displays a bar that indicates the zoom position.

NUMBER

Displays a number (0 to 99) that indicates the zoom position.

FOCUS DISPLAY

► METER

Displays the focal length in meters.

FEET

Displays the focal length in feet.

SHUTTER DISPLAY

► SECOND

Displays the shutter indicator in seconds.

DEGREE

Displays the shutter indicator in degrees.

The shutter speed equal to the period that your camcorder reads image data from the image sensor is defined as 360 degrees. The angle degree is calculated based on this definition and displayed.

When [60i] is selected

- With a frame rate of 60 selected in [REC FORMAT], when the shutter speed is 1/60, the shutter angle is 360 degrees.
- With a frame rate of 30 selected in [REC FORMAT], when the shutter speed is 1/30, the shutter angle is 360 degrees.
- With a frame rate of 24 selected in [REC FORMAT], when the shutter speed is 1/24, the shutter angle is 360 degrees.

When [50i] is selected

- With a frame rate of 50 selected in [REC FORMAT], when the shutter speed is 1/50, the shutter angle is 360 degrees.
- With a frame rate of 25 selected in [REC FORMAT], when the shutter speed is 1/25, the shutter angle is 360 degrees.

See page 48 for details on the [REC FORMAT] setting.

🔍 Note

- The shutter speed displayed when pressing an ASSIGN button assigned with the DATA CODE function is displayed in seconds regardless of this setting.

💡 Tip

- If the shutter speed is more than 360 degrees, it is displayed as an integral multiple of 360 degrees (360 × 2, etc.).

DATA CODE

You can select the information that is displayed during playback.

▶ OFF

No information is displayed.

DATE/TIME

The date and time are displayed.

CAMERA DATA

Camera data is displayed.

Tips

- You can assign this function to an ASSIGN button (p. 85).
- Displayed only during playback.

GAMMA DISP ASSIST

See page 111.

LCD BRIGHT

You can adjust the brightness of the LCD screen. Changes in the LCD brightness are not affect the brightness of recording images.

▶ NORMAL

BRIGHT

Note

- Selection is disabled when connected to an AC Adapter, but is enabled when a battery pack is connected.

VF COLOR TEMP.

You can change the color temperature of the viewfinder.

Low color temperature makes the viewfinder appear reddish, and high color temperature makes it appear bluish.

VF/LCD PANEL

Selects whether the camera image is displayed in the viewfinder or on the LCD screen.

▶ LCD PANEL

The image is always displayed on the LCD screen.

AUTO

Automatically displays image in the viewfinder when you look through the viewfinder. The image is displayed on the LCD screen at all other times.

For details, see page 34.

DISPLAY OUTPUT

You can select where to output the display information, such as time code.

▶ LCD PANEL

Outputs the information to the LCD screen.

ALL OUTPUT

Outputs information to the SDI OUT, HDMI OUT, multi/micro USB jacks, and the LCD screen. Zebra, peaking, and face detection frames are also output.

Note

- Only the time code, zebra, peaking, and face detection frames are output when [MARKER] is set to [ON] and a marker is displayed on the LCD screen.

00:00 (TC/UB SET) menu

Time code settings (TC PRESET/UB PRESET/TC FORMAT, etc.)

The default settings are marked with ►. See page 139 for details on selecting menu items.

Press the MENU button → select 00:00 (TC/UB SET) with the SEL/SET dial.

TC/UB DISPLAY

Switches the display between time code and user bits.

► TC

Displays the time code.

U-BIT

Displays the user bits.

Tip

- You can assign this function to an ASSIGN button (p. 85).

TC PRESET

See page 112.

UB PRESET

See page 112.

TC FORMAT

You can select the time code recording method when [60i/50i SEL] is set to [60i]. This setting is fixed to [NDF] when [50i] is set.

► DF

Records the time code in drop frame.

NDF

Records the time code in non-drop frame.

Note

- This setting is fixed to [NDF] when recording in 1080/24p, even if [60i/50i SEL] is set to [60i].

Tip

Drop frame

Time code is based on 30 frames per second; however, gaps in the actual time occur during extended periods of recording as the actual frame frequency of NTSC image signal is 29.97 frames per second. Drop frame corrects this gap to make time code and actual time equal. In drop frame, the first 2 frame numbers are removed every minute except in every tenth minute. Time code without this correction is called non-drop frame.

TC RUN

You can select how the time code advances.

► REC RUN

Advances the time code only during recording.

Select this setting to record the time code sequentially from the last time code of the previous recording.

FREE RUN

Advances the time code regardless of operation of your camcorder.

Notes

- Even if the time code advances in [REC RUN] mode, the time code may not be recorded sequentially in the following cases:
 - When the recording format is changed.
 - When the images are recorded to the memory card simultaneously.
 - When the memory card is removed.
- [REC RUN] is selected automatically for the Slow & Quick Motion recording and Super Slow Motion recording.

TC MAKE

► PRESET

Records the newly set time code on the memory card.

REGENERATE

Reads the last time code of the previous recording from the memory card and records the new time code consecutively from the last time code.

The time code runs in [REC RUN] mode regardless of the setting of [TC RUN].

UB TIME REC

► OFF

Does not record the time in the user bits.

ON

Records the time in the user bits.

🔁 Note

- The last 2 digits are fixed to 00 when it is set to [ON].

(NETWORK SET) menu

Settings for the Wi-Fi function (CTRL W/
SMARTPHONE, etc.)

The default settings are marked with ►.
**See page 139 for details on selecting
menu items.**

Press the MENU button → select 
(NETWORK SET) with the SEL/SET dial.

CTRL W/SMARTPHONE

See page 88.

STREAMING

See page 97.

FTP TRANSFER

See page 99.

WIRED LAN SET

See page 96.

Wi-Fi SET

See page 92.

AIRPLANE MODE

See page 96.

ROOT CERTIFICATE

See page 101.

NETWORK RESET

See page 102.

(SYSTEM) menu

Settings while recording or other basic settings (AREA SET/BEEP, etc.)

The default settings are marked with ►.
See page 139 for details on selecting menu items.

Press the MENU button → select  (SYSTEM) with the SEL/SET dial.

STATUS CHECK

See page 123.

CAMERA PROFILE

You can save up to 99 camera profile settings in a memory card and recall them at any time for easy setup. In addition, if you should require multiple camcorders with the same settings, you can load the desired settings to all cameras via the memory card.

Notes

- Camera profiles for 50i models and 60i models are not compatible.
- Camera profiles for PXW-FS5 and PXW-FS5M2 are not compatible.
- The file may not be shown properly if the file name is changed on the computer, or the power turned off during generation.
- Formatting the memory card also deletes saved camera profiles.

Tip

- Items that can be saved include setting values for menus, picture profiles, buttons, etc. You can save these setting values all together in the camera profile.

■ LOAD

Load the camera profile, and execute the settings.

- ① Select the camera profile to be loaded with the SEL/SET dial.
- ② Select [YES] on the confirmation screen.

The camcorder restarts, and the loaded camera profile is applied.

Note

- A camera profile saved on a camcorder with different model name, or edited on a computer cannot be loaded.

■ SAVE

You can save the camera profile.

- ① Select [NEW FILE] or an existing profile name with the SEL/SET dial.
- ② Select [YES] on the confirmation screen.
The camera profile is saved.

Tips

- When you select [NEW FILE], the profile is named [01] (when saving for the first time).
- If you select an existing camera profile, the current setting values are overwritten.
- You cannot use a computer to edit saved settings.

■ DELETE

You can delete the saved camera profile.

- ① Select the camera profile to be deleted with the SEL/SET dial.
- ② Select [YES] on the confirmation screen.

S&Q BUTTON SETTING

You can set the functions to assign to the S&Q button.

► S&Q/SUPER SLOW

The setting changes in the order [S&Q MOTION] → [SUPER SLOW MOTION] → Off with each press of the S&Q button.

S&Q MOTION

Set Slow & Quick Motion.

SUPER SLOW MOTION

Set Super Slow Motion.

Note

- Slow & Quick Motion and Super Slow Motion cannot be executed when the FULL AUTO button is on (lit).

S&Q BUTTON SET

See page 72.

ASSIGN BUTTON

See page 85.

ASSIGN DIAL

See page 85.

ASSIGN DIAL DIRECTION

You can set the direction of the ASSIGN dial.

► NORMAL

Normal direction.

OPPOSITE

Opposite direction.

CLOCK SET

See page 33.

AREA SET

You can adjust a time difference without stopping the clock. When you use your camcorder abroad, you can adjust the clock to the local time.

SUMMERTIME

You can change this setting to advance the time by 1 hour during summer months in areas that feature summer time. Set [SUMMERTIME] to [ON] to move the time forward 1 hour.

► OFF

Does not set summer time.

ON

Sets summer time.

LANGUAGE

You can select the language to be used on the LCD screen.

GPS SETTING

See page 115.

GPS INFORMATION

See page 116.

AUTO CLOCK ADJ

See page 116.

AUTO AREA ADJ

See page 117.

DATE REC

► OFF

Does not superimpose the date and time on images.

ON

Superimposes the date and time on images.

Tips

- You can set this item only when the interlace scanning system is selected.
- When zebra or peaking is activated, the date and time characters are affected by the signal, but properly recorded on images.

BEEP

► OFF

Does not emit a beep.

ON

Emits an operation beep.

REC LAMP[F]

▶ **ON**

Turns on the front camera recording lamp.

OFF

Turns off the front camera recording lamp.

 **Tip**

- You can assign this function to an ASSIGN button (p. 85).

REC LAMP[R]

▶ **ON**

Turns on the rear camera recording lamp.

OFF

Turns off the rear camera recording lamp.

 **Tip**

- You can assign this function to an ASSIGN button (p. 85).

HOLD SW SET

You can set what functions will be locked when the HOLD switch is on.

■ **W/REC BUTTON**

Set whether the START/STOP button function is locked.

ON

Locked.

▶ **OFF**

Not locked.

■ **W/GRIP REMOTE**

Set whether the grip remote control and LANC remote control functions are locked.

▶ **ON**

Locked.

OFF

Not locked.

REMOTE CONTROL

▶ **ON**

Enables the supplied Wireless Remote Commander (p. 11).

OFF

Disables the supplied Wireless Remote Commander to prevent misoperation by the remote control of another device.

60i/50i SEL

Select according to the frame rate to record.

▶ **60i**

To record at 24p, 30p, 60i, or 60p.

50i

To record at 25p, 50i, or 50p

 **Note**

- Memory cards formatted and recorded at 60i (50i) cannot be recorded or played back at 50i (60i), and vice versa. If [A movie with a different video signal format from this device has been recorded. Movie recording disabled.] appears on the LCD screen after switching 60i to 50i, or 50i to 60i, try another memory card or run [MEDIA FORMAT].

MEDIA FORMAT

See page 136.

REPAIR IMAGE DB FILE

See page 138.

USB CONNECT

Select this item when [USB CONNECT] does not appear on the LCD screen by connecting the camcorder to another device with the USB cable.

USB LUN SET

You can improve compatibility with external devices by limiting the functions of the USB connection.

► MULTI

Set to [MULTI] in normal conditions.

SINGLE

Set to [SINGLE] if you are unable to connect using the [MULTI] setting.

OPERATION TIME

Displays the total hours of operation in 10-hour increments.

OPTION

Displays the installation status of options.

VERSION DISPLAY

Displays the current version of your camcorder and lens. Be sure to check for firmware updates.

Note

- To perform an update, use the AC Adapter.

INITIALIZE

You can reset all settings, including the clock setting, to their default values.

Note

- The picture profile settings are not reset.

Troubleshooting

If you run into any problems using your camcorder, follow the flow chart below.

① Check your camcorder, referring to the items on pages 168 to 174.



② Disconnect the power source, reconnect the power source after about 1 minute and turn on your camcorder.



③ Press the MENU button and select  (SYSTEM) → INITIALIZE.
This operation will reset the date, time and area settings.



④ Consult your Sony dealer or local authorized Sony service facility.

- Power sources/LCD screen/Wireless Remote Commander (p. 168)
- Memory cards (p. 170)
- Recording (p. 170)
- Playback (p. 172)
- Connecting to TV (p. 173)
- Copying/Editing/Connecting to other devices (p. 174)
- Connecting to a computer (p. 174)
- ND FILTER dial (p. 174)

Power sources/LCD screen/Wireless Remote Commander

The power does not turn on or abruptly turns off.

- Attach a charged battery pack to the camcorder (p. 21).
- Use the AC Adapter to connect the camcorder to a wall outlet (wall socket) (p. 22).

The camcorder does not operate even when the power is set to on.

- Disconnect the power source (battery or AC Adapter), then reconnect it after about 1 minute.
- Check the HOLD switch. Hold state is indicated when an orange portion is visible; release hold state as required.

The camcorder gets warm.

- Camera body may get warm with use – this is normal.

The remaining battery time indicator does not indicate the correct figure.

- Ambient temperature is too high or too low, or the battery pack has not been charged enough. This is not a malfunction.
- Fully charge the battery again. If the problem persists, the battery may be worn-out. Replace with a new battery (p. 21).
- The indicated figure may not be correct in certain circumstances. For example, when you remove the LCD screen, it takes about 1 minute to display the correct remaining battery.

The battery pack discharges too quickly.

- Ambient temperature is too high or too low, or the battery pack has not been charged enough. This is not a malfunction.
- Fully charge the battery again. If the problem persists, the battery may be worn-out. Replace with a new battery (p. 21).

The image on the viewfinder is not clear.

- Move the viewfinder diopter adjustment dial until the image appears clearly (p. 35).

The supplied Wireless Remote Commander does not function.

- Set [REMOTE CONTROL] to [ON] (p. 166).
- Remove any obstructions between the Wireless Remote Commander and the remote sensor of the camcorder.
- Keep strong light sources, such as sunlight or overhead lighting, away from the remote sensor, otherwise the Wireless Remote Commander may not function properly.
- Change the battery. Insert a fresh battery with the +/- terminals aligned correctly (p. 11).

Another video device malfunctions when you use the supplied Wireless Remote Commander.

- Select a commander mode other than DVD2 for your video device.
- Cover the sensor of your video device with black paper.

When a device is connected to the REMOTE jack, the camcorder or the device does not operate properly.

- Check whether the device is compatible or incompatible.
- The connected device may react slowly to some operations.
- If you disconnect the cable from the device while the cable is still connected to the camcorder's REMOTE jack, the camcorder may not restore the proper settings. Disconnect the cable also from the camcorder's REMOTE jack.

Memory cards

The camcorder does not operate with the memory card inserted.

- The memory card was formatted on a computer. Format it on this camcorder (p. 136).
-

The data file name is displayed incorrectly, or flashing.

- The file is damaged.
 - The file format is not supported on your camcorder (p. 185).
-

The memory card indicator is flashing.

- An error occurred with the memory card during recording. Stop recording to all memory cards, and repair the database files.
-

Images on the memory card cannot be deleted.

- You can select no more than 100 images to be deleted on the edit screen.
 - The images are protected. Unprotect the images (p. 134).
-

A repair memory card prompt screen appears.

- There may have been a problem recording to the memory card during the most-recent recording.
 - Press [OK] to repair the card to the extent possible.
 - Press [Cancel] to continue without repairing.
-

Recording

The recording does not start when you press the START/STOP button.

- The playback screen is displayed. Stop playback operation (p. 121).
 - The START/STOP button may be locked by the HOLD switch (p. 6).
 - There is no empty space on the memory card. Replace the memory card with a new one, format the memory card (p. 136), or delete unnecessary images (p. 135).
 - Total number of movie scenes exceeds the recordable capacity of your camcorder (p. 178). Delete unnecessary images (p. 135).
 - The temperature of your camcorder is extremely high. Turn off your camcorder and leave it for a while in a cool place.
 - The temperature of your camcorder is extremely low. Turn off your camcorder and leave it for a while in a warm place.
 - An error occurred with the memory card during recording. Stop recording to all memory cards, and repair the database files.
-

The memory card access lamp remains lit even after recording was stopped.

- Your camcorder is recording the scene you have just shot on the memory card.

The imaging field looks different.

- The imaging field may look different depending on the condition of your camcorder. This is not a malfunction.

The actual recording time for movies is less than the estimated recording time.

- Depending on the recording conditions, the time available for recording may be shorter, for example when recording a fast moving object, etc. (p. 178).

The camcorder does not keep the setting changes.

- Some menu items return to the default setting when the power is turned off.
- The focus magnification setting is not stored.
- The power source has been disconnected when the ON/STANDBY switch is set ON (I). Set the camcorder ON/STANDBY switch to STANDBY (⏻) and save your settings. Before disconnecting the battery or the AC Adapter, set the ON/STANDBY switch to STANDBY (⏻), wait a few seconds, and then remove the power source.

There is a time difference between the point when the record button is pressed and the point that the recording movie actually starts or stops.

- On your camcorder, there may be a slight time difference between the point where you press the record button and the actual point that recording movie starts/stops. This is not a malfunction.

Automatic focus does not function.

- Set the FOCUS switch to “AUTO” to enable automatic adjustment (p. 45).
- Adjust the focus manually if the automatic focus does not work properly (p. 44).

Menu items are grayed out or do not work.

- You cannot select grayed out display items in the current recording/playback situation.
- There are some functions you cannot activate simultaneously. The following list shows examples of unworkable combinations of functions and menu items.

Cannot use (menu disabled)	Situation
[ON/OFF] of [AE SHIFT]	Iris, ISO sensitivity/gain, and shutter speed are all set manually.
[ZEBRA], [PEAKING]	[COLOR BAR] is set to [ON].
[TC PRESET]	[TC MAKE] is set to [REGENERATE].
[COLOR BAR]	[REC FORMAT] is set to [XAVC QFHD].

The iris, ISO sensitivity/gain, shutter speed, and white balance cannot be adjusted manually.

- Press the FULL AUTO button to set full auto mode off.

Tiny spots in white, red, blue, or green appear on the LCD screen.

- This phenomenon appears when using a slow shutter speed (p. 51). This is not a malfunction.
-

The subjects passing by the frame very fast appear crooked.

- This is called the focal plane phenomenon. This is not a malfunction. Because of the way that the image device (CMOS sensor) reads out image signals, the subjects passing by the frame rapidly might appear crooked depending on the recording conditions.
-

Horizontal stripes appear on the image.

- This occurs when recording pictures under a fluorescent lamp, sodium lamp, or mercury lamp. This is not a malfunction. This can be improved by changing the shutter speed (p. 51).
-

The image appears divided horizontally.

- Images on the LCD screen look horizontally divided when a subject is continuously lit with a flash. The effect of this phenomenon may be reduced by using a slower shutter speed.
 - You may try downloading the “Catalyst Browse” software to repair the image.
-

Black bands appear when you record a TV screen or computer screen.

- Adjust the shutter speed (p. 51).
-

Fine patterns flicker, diagonal lines look jagged.

- Adjust [DETAIL] to the negative side (p. 110).
-

The time code is not recorded in sequence.

- The time code may not be recorded sequentially if you change the recording format settings.
-

Playback

Refer also to “Memory cards” (p. 170).

The desired images cannot be found.

Images cannot be played back.

- Select the memory card and image quality of the image you want to play back on the thumbnail screen (p. 119).
- Image data cannot be played back if you have modified file names or folders, or have edited the data on a computer. This is not a malfunction.
- Images recorded on other devices may not be played back, or displayed in incorrect size. This is not a malfunction.
- Display the thumbnail screen, and select the thumbnail of the movie you want to play back with the SEL/SET dial (p. 120).

The data file name is displayed incorrectly, or flashing.

- The file is damaged.
- The file format is not supported on your camcorder (p. 185).
- Only the file name is displayed, if the folder structure does not conform to the universal standard.

No sound or only a low sound is heard.

- Turn up the volume (p. 121).
- Movies recorded with Slow & Quick Motion or Super Slow Motion do not have sound.

“---” is displayed on the LCD screen.

- Bars will be displayed for the camera data of the movies recorded with [COLOR BAR] set to [ON].

Multi ch appears on the LCD screen.

- Multi ch appears when you play back movies recorded with 5.1ch surround sound. 5.1ch surround sound is down-mixed to 2ch stereo and played back on your camcorder.

Connecting to TV

Neither image nor sound is played back on the TV connected with the HDMI cable.

- Images are not output from the HDMI OUT jack if copyright protection signals are recorded in the images.
- Signals are not output from the HDMI OUT jack when the USB jack is connected.

Neither image nor sound is played back on the TV, projector, or AV amplifier connected with the HDMI cable.

- If you cannot view images or hear sound on the TV, projector, or AV amplifier connected with the HDMI cable, try disconnecting and connecting the HDMI cable, or turn on your camcorder again.

The image appears distorted on a 4:3 TV. Or black bands may across the top and bottom of the screen.

- This happens when viewing a movie recorded in 16:9 (wide) mode on a 4:3 TV. Select  (REC/OUT SET) → [VIDEO OUT] → [DOWN CONVERT TYPE] and set the appropriate down conversion type (p. 154).

Copying/Editing/Connecting to other devices

Time code and other information appear on the display of the connected device.

- Set [DISPLAY OUTPUT] to [LCD PANEL] (p. 161).

Sound cannot be added to the recording after recording.

- You cannot add sound to the recording after recording on your camcorder.

Connecting to a computer

The computer does not recognize the camcorder.

- Disconnect the cable from the computer, then connect it again securely.
- Disconnect the cable from your computer and camcorder. Reboot your computer, and connect your computer and camcorder following the steps in the correct order.

Movies cannot be viewed or copied to the computer.

- Disconnect the cable from the computer, then connect it again.
- You need to download the “Catalyst Browse” software to copy movies from your camcorder to your computer.

ND FILTER dial

The ND filter does not move.

- You can move the ND filter to the “CLEAR” position using the following procedure.

- ① Turn off the camcorder.
- ② Remove the round cap.
- ③ Insert a screwdriver into the hole and turn counterclockwise.
Turning the screwdriver counterclockwise moves the ND filter. Turn the screwdriver until the ND filter is in the “CLEAR” position. Use a flat-blade screwdriver of size $\phi 2.4$ or smaller. The screwdriver insertion depth is approximately 1.5 cm (5/8 in.).
- ④ Set the PRESET/VARIABLE switch to “PRESET,” and switch the ND FILTER dial to the “CLEAR” position.

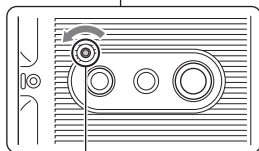
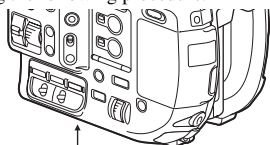

Screwdriver hole
(with cap removed)

Notes

- The procedure above should not be used during normal operation. It should only be used when the ND filter is no longer moving. The ND unit may become damaged if the procedure is used during normal operation.
- After performing the procedure above, the camcorder should be repaired at a service center.
- An error message may appear after performing the procedure above, but the camcorder can still record.

Warning indicators and messages

Self-diagnosis display/Warning indicators

When an error occurs, a warning indicator appears on the LCD screen.

If a problem persists even after you have tried resolving the issue a couple of times, contact your Sony dealer or local authorized Sony service facility.

C:06:□□

- The battery pack is too hot. Replace the battery pack, or remove the battery pack and put it in a cool place.

C:13:□□

- Remove the memory cards. After installing them again, operate your camcorder.

C:32:□□

- Remove the power source. Reconnect it and operate your camcorder again.

E:□□:□□

- Try steps ② to ④ on page 168.

(Battery level warning)

- The battery pack is nearly used up.
- Depending on the operation, environment, or battery conditions, the indicator may flash, even if around 10% is displayed as the battery remaining figure.

(Warning indicators pertaining to battery pack temperature)

- The battery pack is too hot. Replace the battery pack, or remove the battery pack and put it in a cool place.

(Warning indicators pertaining to memory cards)

Slow flashing

- Free spaces for recording images are running out. For details about memory cards you can use with your camcorder, see page 38.
- No memory card is inserted (p. 38).

Fast flashing

- There are not enough free spaces for recording images. Delete unnecessary images (p. 135), or format the memory card (p. 136) after storing the images on other media.
- The image database file may be damaged (p. 138).

(Warning indicator pertaining to memory card formatting)*

- The memory card is damaged.
- The memory card is not formatted correctly (p. 136).

(Warning indicator pertaining to incompatible memory cards)*

- An incompatible memory card is inserted (p. 38).

(Warning indicator pertaining to the write-protect of the memory card)*

- The write-protect switch is set to lock position on the memory card.
- Access to the memory card was restricted on another device.

Fast flashing

- The image database file may be damaged (p. 138).

* When [BEEP] is set to [ON] (p. 165), you hear a beep when the warning indicators appear on the LCD screen.

Warning messages

If a warning message is displayed, follow the instructions.

Error messages

The following error messages may appear if trouble occurs during FTP transfer or streaming distribution. Try the solution suggested on the display.

No registered access point.

There are no access points registered. Select  (NETWORK SET) → [ACCESS POINT SET], and register an access point.

Cannot find connectable access point.

Set the access point setting.

An access point could not be found. Select  (NETWORK SET) → [ACCESS POINT SET], and check the access point settings.

Connection to the access point failed.

Please input your password again.

Could not connect to the access point. Try re-entering the password for the access point.

Connection with an access point disconnected.

Check the connection condition.

Connection to the access point was disconnected. Check the access point connection conditions.

No response from the access point.

There was no response from the access point. Check the connection with the access point.

Failed to acquire an IP address. Change the IP address setting.

Could not acquire the IP address.

If connecting to a network via a wireless LAN, select  (NETWORK SET) → [ACCESS POINT SET], and specify the IP address manually.

If connecting to a network via a wired LAN, select  (NETWORK SET) → [WIRED LAN SET], and specify the IP address manually.

Network error occurred.

A Wi-Fi communication error occurred.

Check the LAN cable connection.

Could not connect to the network. Check the LAN cable connection.

Failed to connect to an FTP server.

Check the FTP server settings.

Check the registered FTP server settings.

Failed to connect to an FTP server.

Connection to the FTP server failed because the FTP server could not be found or for other reasons.

Could not verify the certificate.

The FTP server certificate is not valid.

Connection to the FTP server disconnected.

Connection to the FTP server was disconnected.

Cannot upload to the FTP server.

Connection to the FTP server was successful, but a file could not be transferred. Check the transfer destination directory settings and the settings on the FTP server.

Unable to access the media.

The memory card could not be loaded. The memory card may be damaged.

Recording time

Estimated recording time of movies

(Unit: minute)

XAVC QFHD

4K (QFHD)	2160	
	60Mbps	100Mbps
64GB	100 (100)	65 (65)

4K (QFHD) + PROXY (9M)	2160	
	60Mbps	100Mbps
64GB	85 (85)	55 (55)

XAVC HD

XAVC	1080			720
	50Mbps	35Mbps	25Mbps	50Mbps
64GB	120 (120)	170 (170)	220 (220)	120 (120)

XAVC + PROXY (9M)	1080			720
	50Mbps	35Mbps	25Mbps	50Mbps
64GB	100 (100)	135 (135)	160 (160)	100 (100)

XAVC + PROXY (3M)	1080			720
	50Mbps	35Mbps	25Mbps	50Mbps
64GB	110 (110)	155 (155)	195 (195)	110 (110)

AVCHD

- When [AVCHD AUDIO FORMAT] is set to [LINEAR PCM]

(Unit: minute)

	PS	FX	FH	HQ
16GB	70 (70)	80 (80)	110 (110)	185 (145)
32GB	145 (145)	170 (170)	225 (225)	290 (290)
64GB	290 (290)	340 (340)	450 (450)	590 (590)

- When [AVCHD AUDIO FORMAT] is set to [DOLBY DIGITAL]

(Unit: minute)

	PS	FX	FH	HQ
16GB	75 (75)	90 (90)	120 (120)	215 (165)
32GB	150 (150)	180 (180)	245 (245)	440 (330)
64GB	305 (305)	360 (360)	495 (495)	880 (665)

- When using Sony memory card.
- The number in () is the minimum recordable time.

Note

- The recording time may vary depending on the recording conditions, subjects, and [REC SET] (p. 153).

Tips

- The maximum number of scenes that can be recorded is 600 in XAVC HD/QFHD and 3,999 in AVCHD.
- The continuous recording time using relay recording is 6 hours for XAVC HD/QFHD and 13 hours for AVCHD.
- Your camcorder uses the VBR (Variable Bit Rate) format to automatically adjust image quality to suit the recording scene. This technology causes fluctuations in the recording time of the memory card. For example, movies containing quickly moving and complex images are recorded at a higher bit-rate, and this reduces the overall recording time of the memory card.

- Bit-rate (movie + audio, etc.) and number of pixels of each file format are as follows.

- XAVC QFHD

- 100 Mbps 3840×2160

- 60 Mbps 3840×2160

- XAVC HD

- 50 Mbps 1920×1080

- 35 Mbps 1920×1080

- 25 Mbps 1920×1080

- 50 Mbps 1280×720

- AVCHD

- PS: max 28Mbps 1920×1080

- FX: max 24Mbps 1920×1080, 1280×720

- FH: approx. 17Mbps (avg) 1920×1080,
1280×720

- HQ: approx. 9Mbps (avg) 1440×1080,
1280×720

Function limitations when recording

Recording format limitations

Yes: Supported, No: Not supported

Function	XAVC QFHD	XAVC HD	AVCHD
FACE DETECTION	Yes (See page 133)	Yes	Yes
COLOR BAR	No	Yes (when proxy recording is OFF)	Yes (when proxy recording is OFF)
CENTER SCAN	No	Yes	Yes
SUPER SLOW MOTION	No	Yes	Yes
S&Q MOTION	Yes	Yes	Yes
STREAMING	Yes (60 Mbps only)	Yes	Yes
DATE REC	No	Yes (Interlaced recording)	Yes (Interlaced recording)
SIMULTANEOUS REC	Yes	Yes	Yes
RELAY REC	Yes	Yes	Yes
PROXY REC MODE	Yes	Yes	No
Simultaneous recording + Proxy recording	Yes (60 Mbps only)	Yes	No
Relay recording + Proxy recording	Yes (60 Mbps only)	Yes	No

Slow & Quick Motion and Super Slow Motion limitations

Yes: Supported, No: Not supported

Function	Slow & Quick Motion	Super Slow Motion
FACE DETECTION	No	No
COLOR BAR	No	No
CENTER SCAN	Yes	No
STREAMING	No	No
DATE REC	No	No
SIMULTANEOUS REC/ RELAY REC	No	No
PROXY REC MODE	No	No
Wi-Fi remote control	No	No
Full auto mode	No	No
HISTOGRAM	Yes	No
PEAKING	Yes	Yes
ZEBRA	Yes	Yes
WB SET	Yes	No
FOCUS MAGNIFIER	Yes	Yes
CLEAR IMAGE ZOOM	Yes	No

Proxy recording supported formats

Note

- Proxy recording is not supported when the following three are selected at the same time.
 - Recording mode: 4K (XAVC QFHD)
 - Recording format bit rate: 100Mbps
 - Simultaneous/relay recording: ON

Original file		Proxy file					
Image size		1280×720			640×360		
	Frame rate (fps)	60(50)p	30(25)p	24p	60(50)p	30(25)p	24p
		Bit rate (Mbps)	9	9	9	3	3
3840× 2160	30(25)p	100	Yes		Yes		
		60	Yes		Yes		
	24p	100			Yes	Yes	
		60			Yes	Yes	
1920× 1080	60(50)p	50	Yes			Yes	
		35	Yes			Yes	
	60(50)i	50	Yes		Yes		
		35	Yes		Yes		
		25	Yes		Yes		
	30(25)p	50	Yes		Yes		
		35	Yes		Yes		
	24p	50			Yes	Yes	
		35			Yes	Yes	
	1280× 720	60(50)p	50	Yes			Yes

Streaming supported formats

Original file (XAVC)			Streaming data				
Image size			1280×720		640×360		
	Frame rate (fps)		30(25)p	24p	60(50)p	30(25)p	24p
		Bit rate (Mbps)	3	3	2	1	1
3840×2160	30(25)p	60	Yes			Yes	
	24p	60		Yes			Yes
1920×1080	60(50)p	50			Yes		
		35			Yes		
	60(50)i	50	Yes			Yes	
		35	Yes			Yes	
		25	Yes			Yes	
	30(25)p	50	Yes			Yes	
		35	Yes			Yes	
		24p	50		Yes		Yes
		35		Yes		Yes	
1280×720	60(50)p	50			Yes		

Original file (AVCHD)			Streaming data				
Image size			1280×720		640×360		
	Frame rate (fps)		30(25)p	24p	60(50)p	30(25)p	24p
		Bit rate (Mbps)	3	3	2	1	1
1920×1080	60(50)p	PS					
	60(50)i	FX	Yes			Yes	
		FH	Yes			Yes	
	30(25)p	FX	Yes			Yes	
		FH	Yes			Yes	
	24p	FX			Yes		Yes
FH				Yes		Yes	
1280×720	60(50)p	FX					
		FH					
		HQ					

Using your camcorder abroad

Power supply

You can use your camcorder in any country/region using the AC Adapter supplied with your camcorder within the 100 V to 240 V AC, 50Hz/60 Hz range.

Viewing on TV

Before recording a movie with your camcorder for viewing on a TV, set [60i/50i SEL] to the appropriate TV system for the country/region in which you intended to view the movie. The following shows which countries and regions require [60i] or [50i] setting.

Countries/regions that require [60i/50i SEL] set to [60i]

Barbados, Bermuda, Bolivia, Canada, Chile, Colombia, Costa Rica, Cuba, Dominican Republic, Ecuador, El Salvador, Guam, Guatemala, Guyana, Haiti, Honduras, Japan, Korea, Mexico, Micronesia, Myanmar, Nicaragua, Panama, Peru, the Philippines, Puerto Rico, Saint Lucia, Samoa, Surinam, Taiwan, Trinidad and Tobago, the U.S.A., Venezuela, etc.

Countries/regions that require [60i/50i SEL] set to [50i]

Argentina, Australia, Austria, Belgium, Brazil, Bulgaria, China, Croatia, Czech Republic, Denmark, Finland, France, French Guiana, Germany, Greece, Hong Kong, Hungary, Indonesia, Iran, Iraq, Italy, Kuwait, Malaysia, Monaco, the Netherlands, New Zealand, Norway, Paraguay, Poland, Portugal, Romania, Russia, Singapore, Slovak Republic, Spain, Sweden, Switzerland, Thailand, Turkey, Ukraine, United Kingdom, Uruguay, Vietnam, etc.

Simple setting of the clock by time difference

When you are abroad, you can easily adjust the clock to the local time by setting the time difference. Select [AREA SET], then set the time difference (p. 165).

File/folder structure on the memory card

The memory card file/folder structure is shown below. You do not usually need to acknowledge the file/ folder structure, when recording/playing back movies and still images on the camcorder.

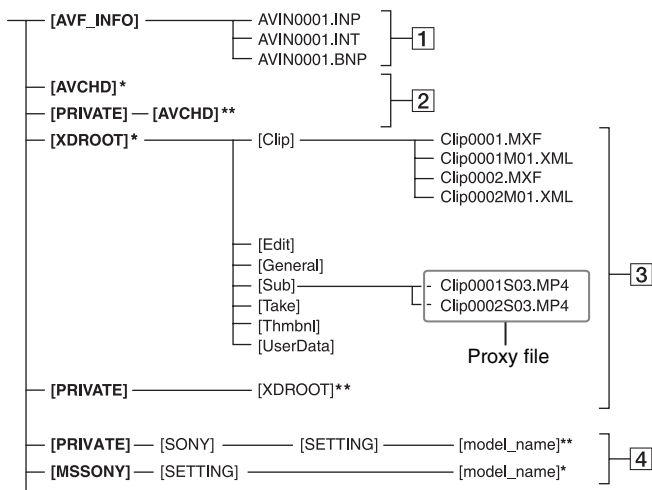

* “Memory Stick PRO Duo”

** SD memory card, SDHC memory card, SDXC memory card

1 Image management files

When you delete the files, you cannot record/play back the images correctly.

The files are defaulted as hidden files and not usually displayed.

2 AVCHD movie management information folder

This folder contains recording data of AVCHD movie files. Do not modify the files or folders on the camcorder from the computer. Doing so might damage image files, or prevent image files from being played back.

3 XAVC HD/4K (QFHD) movie management information folder

This folder contains recording data of XAVC HD/4K (QFHD) movie files. Do not modify the files or folders on the camcorder from the computer. Doing so might damage image files, or prevent image files from being played back.

The file numbers increment automatically.

4 Camera profiles folder

Stores files saved in a camera profile.

The folder name may vary with the country or region.

Data in folders with a different folder name are incompatible (p. 164).

For SD cards:

PRIVATE/SONY/SETTING/model_name

For Memory Stick:

MSSONY/SETTING/model_name

Maintenance and precautions

About the XAVC format

Recording and playback on your camcorder

Your camcorder can record 4K (QFHD) and HD (high definition) based on the XAVC format.

This uses a Long-GOP video compression format for recording.

Video signal*: MPEG-4AVC/H.264

When [60i] is selected:

3840×2160/30p, 3840×2160/24p,
1920×1080/60p, 1920×1080/60i,
1920×1080/30p, 1920×1080/24p,
1280×720/60p

When [50i] is selected:

3840×2160/25p, 1920×1080/50p,
1920×1080/50i, 1920×1080/25p,
1280×720/50p

Audio signal: LPCM 2ch

Recording media: Memory card

* The camcorder is not able to play back data that is recorded in XAVC format using settings other than those described above.

About the AVCHD format

Recording and playback on your camcorder

Based on the AVCHD format, your camcorder records with the HD (high definition) image quality.

Video signal*: MPEG-4 AVC/H.264

When [60i] is selected:

1920×1080/60p, 1920×1080/60i,
1920×1080/24p, 1280×720/60p,
1440×1080/60i

When [50i] is selected:

1920×1080/50p, 1920×1080/50i,
1280×720/50p, 1440×1080/50i

Audio: Dolby Digital 2ch, LPCM 2ch

Recording media: Memory card

* Data recorded in AVCHD format other than the above mentioned cannot be played back on your camcorder.

About memory cards

- A memory card formatted (initialized) by a computer does not have guaranteed compatibility with your camcorder.
- Data read/write speed may vary depending on the combination of the memory card and memory card compliant product you use.
- Damaged or lost image data will not be compensated for, and may occur in the following cases:
 - If you eject the memory card, turn the power off on your camcorder, or remove the battery pack for replacement while your camcorder is reading or writing image files on the memory card (while the memory card access lamp is lit or flashing).
 - If you use the memory card near electric fields, magnetic fields, or other sources of electromagnetic noise.
- It is recommended to make a back-up of important data on the hard disk of a computer.
- Do not attach a label or the like on memory card or a memory card adapter.
- Do not touch, or allow metallic objects to come into contact with the terminals.
- Do not bend, drop or apply strong force to the memory card.
- Do not disassemble or modify the memory card.
- Do not let the memory card get wet.
- Be careful to keep memory card out of the reach of small children. There is danger that a child might swallow it.
- Do not insert anything other than the compliant size of memory card into the memory card slot. A malfunction may be caused.
- Do not use or keep the memory card in the following locations:
 - Places subject to extremely high temperature, such as a car parked outside in the summer
 - Places under direct sunlight
 - Places with extremely high humidity or subject to corrosive gases

On image data compatibility

- If you cannot use a memory card that has been used with another device, format it with your camcorder (p. 136). Note that formatting erases all information on the memory card.
- You may not be able to play back images with your camcorder:
 - When playing back image data modified on your computer.
 - When playing back image data recorded with other devices.

About “Memory Stick” media

Types of “Memory Stick”	Recording/ Playback
“Memory Stick Duo” (with MagicGate)	No
“Memory Stick PRO Duo” (Mark2)	Yes
“Memory Stick PRO-HG Duo”	Yes

- This product supports parallel data transfer. However, the transfer speed may differ, depending on the type of media you use.
- This product cannot record or play data that uses “MagicGate” technology. “MagicGate” is a copyright protection technology that records and transfers the contents in an encrypted format.

About the battery pack

To charge the battery pack

- Be sure to charge the battery pack before you start using your camcorder.

To use the battery pack effectively

- Battery pack performance decreases when the ambient temperature is 10 °C (50 °F) or below, and the length of time you can use the battery pack becomes shorter. In that case, do one of the following to use the battery pack for a longer time.
 - Put the battery pack in a pocket to warm it up, and install it in your camcorder right before you start taking shots.
 - Use a high capacity battery pack.

- Be sure to set the ON/STANDBY switch to STANDBY when not recording or playing back on your camcorder. The battery pack is also consumed when your camcorder is in recording standby or playback pause.
- Have spare battery packs ready for 2 or 3 times the expected recording time, and make trial recordings before making the actual recording.
- Do not expose the battery pack to water. The battery pack is not water resistant.

About storage of the battery pack

- If the battery pack is not used for a long time, fully charge the battery pack and use it up on your camcorder once a year to maintain proper function. To store the battery pack, remove it from your camcorder and put it in a dry, cool place.
- To discharge the battery pack on your camcorder completely, leave your camcorder in recording standby until the power goes off.

About battery life

- Battery capacity decreases over time and through repeated use. If decreased usage time between charges becomes significant, it is probably time to replace it with a new one.
- Each battery’s life is governed by storage, operating and environmental conditions.

About charging the battery pack

- Use the charger (supplied) to charge the designated batteries only. If you charge other types of batteries, those batteries may leak, heat up, burst, or give an electric shock, resulting in burns or injury.
- Remove the charged battery from the charger.
- The charge lamp of the supplied charger flashes in 2 patterns as follows:
 - Fast-flashing...Turns on and off rapidly at about 0.15-second intervals.
 - Slow-flashing...Turns on and off alternately for about 1.5 seconds, and turns off completely for about 1.5 seconds. The lamp repeats this sequence.
- If the charge lamp is fast-flashing, remove the battery that is being charged, and then reattach the same battery again firmly. If the charge lamp continues fast-flashing, the cause could be that the battery is damaged, or the battery is not a designated type. Check the battery to confirm whether it is a designated type or not. If it is a

Maintenance and precautions (continued)

designated type, remove the battery first, and then attach a brand-new battery or another known-to-be-good battery to see if the charger is working correctly. If the charger is working correctly, the cause could be that the battery is damaged.

- If the charge lamp is slow-flashing, the charger is in standby mode and charging is suspended. When the ambient temperature is out of the appropriate temperature range for charging, the charger suspends charging automatically and enters standby mode. When the ambient temperature returns to an appropriate temperature, the Charger restarts charging and the charge lamp lights up. We recommend charging the battery pack in an ambient temperature of from 10 °C to 30 °C (50 °F to 86 °F).

About handling of your camcorder

On use and care

- Do not use or store the camcorder and accessories in the following locations.
 - Anywhere extremely hot or cold. Never leave them exposed to temperatures above 60 °C (140 °F), such as under direct sunlight, near heaters or in a car parked in the sun. They may malfunction or become deformed.
 - Near strong magnetic fields or mechanical vibration. The camcorder may malfunction.
 - Near strong radio waves or radiation. The camcorder may not be able to record properly.
 - Near AM receivers and video equipment. Noise may occur.
 - On a sandy beach or anywhere dusty. If sand or dust gets in your camcorder, the camcorder may malfunction. Sometimes this malfunction cannot be repaired.
 - Near windows or outdoors, where the LCD screen, the viewfinder, or the lens may be exposed to direct sunlight. This damages the inside of the viewfinder or the LCD screen.
 - Anywhere very humid.
- Operate your camcorder on 14.4 V DC (battery pack) or 12.0 V DC (AC Adapter).
- For DC or AC operation, use the accessories recommended in these operating instructions.
- Do not let your camcorder get wet, for example, from rain or sea water. If your camcorder gets wet, it may malfunction. Sometimes this malfunction cannot be repaired.
- If any solid object or liquid gets inside the casing, unplug your camcorder and have it checked by a Sony dealer before operating it any further.
- Avoid rough handling, disassembling, modifying, physical shock, or impact, such as hammering, dropping or stepping on the product. Be particularly careful of the lens.
- Do not use a deformed or damaged battery pack.
- Keep the ON/STANDBY switch set to STANDBY when you are not using your camcorder.
- Do not wrap your camcorder with a towel, for example, and operate it. Doing so might cause heat to build up inside.
- When disconnecting the power cord (mains lead), pull it by the plug and not the lead.
- Do not damage the power cord (mains lead), such as by placing anything heavy on it.
- Keep metal contacts clean.
- Keep the Wireless Remote Commander and button-type battery out of children's reach. If the battery is accidentally swallowed, consult a doctor immediately.
- If the battery electrolytic liquid has leaked,
 - consult your local authorized Sony service facility.
 - wash off any liquid that may have contacted your skin.
 - if any liquid gets in your eyes, wash with plenty of water and consult a doctor.

■ When not using your camcorder for a long time

- Turn on the camcorder and record and play back images about once a month to keep it in an optimum state for a long time.

Moisture condensation

If your camcorder is brought directly from a cold place to a warm place, moisture may condense inside your camcorder and cause a malfunction of your camcorder.

■ If moisture condensation has occurred

Leave your camcorder for about 1 hour without turning it on.

■ Note on moisture condensation

Moisture may condense when you bring your camcorder from a cold place into a warm place (or vice versa) or when you use your camcorder in a humid place as shown below.

- When you bring your camcorder from a ski slope into a place warmed up by a heating device.
- When you bring your camcorder from an air conditioned car or room into a hot place outside.
- When you use your camcorder after a squall or a shower.
- When you use your camcorder in a hot and humid place.

■ How to avoid moisture condensation

When you bring your camcorder from a cold place into a warm place, put your camcorder in a plastic bag and seal it tightly. Remove the bag when the air temperature inside the plastic bag has reached the ambient temperature (after about 1 hour).

LCD screen

- Do not exert excessive pressure on the LCD screen, as it may cause damage.
- If your camcorder is used in a cold place, a residual image may appear on the LCD screen. This is not a malfunction.
- While using your camcorder, the back of the LCD screen may heat up. This is not a malfunction.

■ To clean the LCD screen

The LCD screen is covered with a coating. The coating may be peeled off by scratching or rubbing. Maintain the LCD screen as follows.

- Wipe fingerprints or hand cream off the LCD screen as soon as possible, as they may cause the coating to peel off.
- If you rub the LCD screen hard, even with a tissue, the coating may be damaged.
- Before wiping the LCD screen, blow dust or sand off with a dust blower, etc.
- Wipe dirt off the LCD screen with a clean, soft cloth, such as an eye glass cleaning cloth, etc.

About the display of the organic EL panel

Because of the physical characteristics of the organic EL panel, image persistence or low brightness may occur.

These problems are not a malfunction, and the organic EL panel can be used without problems.

Casing

- If the casing is soiled, clean the camcorder body with a soft cloth lightly moistened with water, and then wipe the casing with a dry soft cloth.
- Avoid the following to prevent damage to the finish.
 - Using chemicals, such as thinner, benzine, alcohol, chemical cloths, repellent, insecticide and sunscreen.
 - Handling with above substances on your hands.
 - Leaving the casing in contact with rubber or vinyl objects for a long period of time.

Care and storage of the lens

- Wipe the surface of the lens clean with a soft cloth in the following instances: When there are fingerprints on the lens surface. In hot or humid locations when the lens is exposed to salty air, such as at the seaside.
- Store in a well-ventilated location subject to little dirt or dust.
- To prevent mold, periodically clean the lens as described above.

Charging the pre-installed rechargeable battery

Your camcorder has a pre-installed rechargeable battery to retain the date, time, and other settings even when the ON/STANDBY switch is set to STANDBY. The pre-installed rechargeable battery is always charged while your camcorder is connected to the wall outlet (wall socket) via the AC Adapter or while the battery pack is attached. The rechargeable battery will be fully discharged in about **2 months** if you do not use your camcorder at all without the AC Adapter connected or the battery pack attached. Use your camcorder after charging the pre-installed rechargeable battery.

However, even if the pre-installed rechargeable battery is not charged, the camcorder operation will not be affected as long as you are not recording the date.

Maintenance and precautions (continued)

■ Charging procedure

Connect your camcorder to a wall outlet (wall socket) using the supplied AC Adapter or attach a charged battery, and leave it with the ON/STANDBY switch set to STANDBY (⏻) for more than 24 hours.

Note on disposal/transfer of memory cards

Even if you use [MEDIA FORMAT] or [DELETE], data from the memory card may not be deleted completely. When you give the memory card to somebody, it is recommended that you delete data completely using data deletion software on a computer. Also, when you dispose of the memory card, it is recommended that you destroy the actual body of the memory card.

Specifications

General

Power requirements

12.0 V DC (AC Adapter)

14.4 V DC (battery pack)

Power consumption

[60i]

When using viewfinder, external devices disconnected, SELP18105G lens attached: Approx. 11.8 W

[60i]

When using LCD screen, external devices connected, SDI output, SELP18105G lens attached, XAVC HD 1080/60p, 50 Mbps, memory card simultaneously recording:

Approx. 16.8 W

[50i]

When using viewfinder, external devices disconnected, SELP18105G lens attached: Approx. 11.5 W

[50i]

When using LCD screen, external devices connected, SDI output, SELP18105G lens attached, XAVC HD 1080/50p, 50 Mbps, memory card simultaneously recording:

Approx. 16.4 W

Operating temperature

0 °C to 40 °C (32 °F to 104 °F)

Storage temperature

-20 °C to +60 °C (-4 °F to +140 °F)

Dimensions

Approx. 111.3 mm × 128.7 mm × 172.4 mm (4 1/2 in. × 5 1/8 in. × 6 7/8 in.) (body only, including projecting parts)

Approx. 185.2 mm × 218.3 mm × 369.5 mm (7 3/8 in. × 8 5/8 in. × 14 5/8 in.)

(including SELP18105G, lens hood, large eyecup, LCD screen, handle, grip w/o grip belt, including projecting parts)

(width / height / depth)

Mass

Approx. 830 g (1 lb 13 oz) (body only)

Approx. 2.2 kg (4 lb 14 oz) (including SELP18105G, lens hood, eyecup, BP-U35 battery pack, LCD screen, handle, grip w/o grip belt)

System

Signal format

When 60i is selected:

NTSC color, EIA standards

HDTV 1080/60i, 1080/60p, 720/60p specification

When 50i is selected:

PAL color, CCIR standards

HDTV 1080/50i, 1080/50p, 720/50p specification

Video recording format

XAVC QFHD: MPEG-4 AVC/H.264

4:2:0 Long profile

XAVC HD: MPEG-4 AVC/H.264

4:2:2 Long profile

AVCHD: MPEG-4 AVC/H.264

AVCHD 2.0 standard

Audio recording format

XAVC: Linear PCM 2ch, 24-bit, 48 kHz

AVCHD: Linear PCM 2ch, 16-bit, 48 kHz / Dolby Digital 2ch, 16-bit, 48 kHz

Recording media

“Memory Stick”

SD card

Camera

Imaging device

Exmor Super35 CMOS sensor

Effective picture elements

3840 (H) × 2160 (V) (16:9)

4096 (H) × 2160 (V) (17:9, during RAW output)

Specifications (continued)

Lens mount

E-mount

Minimum illumination

60i: 0.16 lux (F1.4, 1/24 shutter speed, auto gain)

50i: 0.18 lux (F1.4, 1/25 shutter speed, auto gain)

Shutter speed

60i: 1/8 sec. to 1/10,000 sec.

50i/24p: 1/6 sec. to 1/10,000 sec.

Slow & Quick Motion, Super Slow

Motion

Switchable frame rate

Gain

0, 3, 6, 9, 12, 15, 18, 24, 27, 30, 33 dB, AGC

Gamma curve

Switchable

Built-in ND filter

CLEAR: Off

1: $\frac{1}{4}$ ND

2: $\frac{1}{16}$ ND

3: $\frac{1}{64}$ ND

Linear variable ND range:

$\frac{1}{4}$ ND to $\frac{1}{128}$ ND

ISO sensitivity

ISO2000 (S-Log2/S-Log3 gamma)

Horizontal resolution

1000 TV lines or more (1920×1080i)

Input/outputs

Video output/audio output

Integrated into multi/micro USB jack, Composite (1.0 Vp-p, 75 Ω)

SDI signal output

BNC type (1), SD/HD/3G (Level-B) switchable

SMPTE 259M/292M/424M/425M standards

HDMI output

Type A (1)

USB

Multi/micro USB jack (1)

🎧 (headphones) output

Stereo minijack (ø3.5 mm) (1)

Audio input

XLR-type 3-pin (female) (2), line/mic+mic+48 V switchable

DC input

DC jack

REMOTE jack

Stereo minimini jack (ø2.5 mm) (1)

Wired LAN

LAN terminal

100BASE-TX/10BASE-T

Display

LCD screen

8.8 cm (3.5 type)

Approx. 1.56M dots

Viewfinder

1.0 cm (0.39 type)

Approx. 1.44M dots

Internal microphone

Omni-directional stereo electret condenser microphone

Continuous operating time

When recording, LCD screen on, viewfinder off, no external devices connected.

Using BP-U35 battery pack:

[60i] Approx. 2 hours 40 minutes

[50i] Approx. 2 hours 40 minutes

Wireless LAN

Supported standards

IEEE 802.11b/g/n

Frequency band

2.4 GHz band

Security

WEP/WPA-PSK/WPA2-PSK

NFC

NFC Forum Type 3 Tag compliant

Design and specifications are subject to change without notice.

Index

Numeric

24p/30p OUTPUT	154
25p OUTPUT	154
4K	48
60i/50i SEL.....	166

A

AC Adapter.....	21
Access point	92
Accessory shoe.....	27
ACTIVE	151
AE SHIFT.....	149, 171
AF MICRO ADJUSTMENT	152
AGC LIMIT	148
AIRPLANE MODE	163
AMOUNT	152
AREA SET	165
ASPECT	159
ASSIGN BUTTON	85
ASSIGN buttons/ASSIGN dial	85
ASSIGN DIAL DIRECTION	165
AUDIO LEVEL	82
AUDIO LEVEL DISPLAY	160
AUDIO LIMIT	156
AUDIO SET menu	155
AUTO BACK LIGHT.....	151
AUTO ISO LIMIT	148
AUTO/MAN	82
Auto ND filter	54
AVCHD.....	48, 186
AVCHD AUDIO FORMAT	155

B

BATT RELEASE.....	21
Battery	21
BEEP	165
BLACK BALANCE.....	56

Black balance.....	56
BLACK GAMMA	105
BLACK LEVEL	105

C

CAMERA DATA DISPLAY	159
CAMERA/PAINT menu.....	147
CAMERA PROFILE	164
CENTER	158
CENTER SCAN	150
CH1 INPUT SELECT	155
CH2 INPUT SELECT	156
CLEAR ALL.....	152
CLOCK SET.....	33
COLOR BAR.....	152, 171
COLOR CORRECTION	108
COLOR DEPTH	108
COLOR MODE	107
COLOR PHASE	107
Connect	
TV.....	124
Content Browser Mobile.....	87
CTRL W/SMARTPHONE	163

D

DATA CODE	161
Data code	122
Date and time.....	13, 33, 34
DATE REC	165
DELETE	135
DETAIL.....	110
DF	162
Direct Menu	61
DISPLAY.....	122
DISPLAY OUTPUT.....	161
DISPLAY SET menu.....	158
DIVIDE.....	134
DOWN CONVERT TYPE	154

Drop frame	162
------------------	-----

F

FACE DETECTION	47
FILE FORMAT	48
FOCUS	44
FOCUS DISPLAY	160
Focus hold	45
FOCUS MAG.....	10, 46
FOCUS MAG RATIO	159
Focus magnifier.....	46
Format media.....	136
FREE RUN	162
FTP	99
FULL AUTO.....	102
Full auto mode.....	102
Function limitations.....	180

G

Gain	51
GAIN SET	148
GAMMA	105
GAMMA DISP ASSIST.....	161
Gamma display assist.....	111
GPS function	115
Grip.....	31
angle adjustment	36
rotate lever	10
GUIDEFRAAME.....	159

H

Handle record button.....	6, 42
Handle zoom	43
HDMI	124
HDMI TC OUTPUT	155
HDR	57
Headphone output	84
HFR	68
High dynamic range	57
High frame rate.....	68
HISTOGRAM	158

HOLD7
HOLD SW SET166

I

Image database file138
INDOOR55
INITIALIZE167
INPUT 1/INPUT 282
INPUT1 TRIM157
INPUT1 WIND157
INPUT2 TRIM157
INPUT2 WIND157
INT MIC SET156
Iris50
ISO/GAIN51
ISO/GAIN SEL147
ISO sensitivity51
ISO SET147

K

KNEE106

L

LANGUAGE165
Large eyecup36
LAST SCENE REVIEW ...113
Last Scene Review113
LCD BRIGHT161
LCD screen10
 adjusting35
 connection29
 inverting114
Lens23, 189
 mount adapter25
LENS COMPENSATION
.....150
Lithium battery11

M

MANU WB TEMP55
MARKER158

MEDIA FORMAT136

Memory card38
 file/folder structure185
 formatting136
 notes186
“Memory Stick”187
“Memory Stick PRO Duo”
.....187

Menu139
 AUDIO SET155
 CAMERA/PAINT147
 DISPLAY SET158
 items141
 NETWORK SET163
 REC/OUT SET153
 SYSTEM164
 TC/UB SET162
Menu, using139
MIC+48V83

Microphone
 external28
 internal82
 Multi-interface shoe83
MIRROR10, 114
Moisture condensation188
Mount adapter25
MPEG HD recording73
Multi-interface shoe6
Multi/micro USB jack9
Multi-selector10

N

ND filter53
ND/IRIS53
ND/IRIS DIAL DIRECTION
.....150
NDF162
Network functions92
NETWORK RESET163
NETWORK SET menu163
NFC88

O

OPERATION TIME167
Option5
OUTDOOR55
OUTPUT SELECT153
Output signal format125

P

PEAKING158, 171
Picture profile103
Playback119
Power cord22
Power outlet22
Pre-installed rechargeable
battery189
Preparation19
Preset mode53
PROTECT134
PROXY REC MODE49
Proxy recording49
PUSH AUTO50
Push auto focus45

R

RAW format recording70
REC BUTTON SETTING ...42
REC FORMAT48
REC LAMP[F]166
REC LAMP[R]166
REC/OUT SET menu153
REC RUN162
REC SET153
Rechargeable battery pack ...21
Record button40
Recording format48
 AVCHD48
 RAW71
 XAVC HD48
 XAVC QFHD48
Recording lamp40
Recording time178

Index (continued)

- Relay recording 41
REMOTE 31
REMOTE CONTROL 166
Remote control 11, 166
REPAIR IMAGE DB FILE
..... 138
ROOT CERTIFICATE 163
Root certificate 101
- S**
- S&Q 64
S&Q BUTTON SETTING
..... 164
S&Q MOTION 63
SAFETY ZONE 159
SATURATION 107
Screen indicators 12, 122
SDI 124
SDI/HDMI 154
SDI/HDMI REC CONTROL
..... 155
SEL/SET 7
Self-diagnosis display 176
Shoe plate 27
Shooting 40
Shoulder strap 6, 8
SHUTTER 51
SHUTTER DISPLAY 160
Shutter speed 51
SIMUL/RELAY REC 42
Simultaneous recording 42
SLOT SEL 39
SLOW & QUICK 63
Slow & Quick Motion 63
Smartphone 88
Specifications 191
START/STOP
 Body 7
 Grip 10
STATUS CHECK 164
Status check 123
- STEADYSHOT 151
STREAMING 97, 163
Streaming 97
SUMMERTIME 165
SUPER SLOW MOTION 65
Super Slow Motion 65
Supplied items 19
SYSTEM menu 164
- T**
- TC FORMAT 162
TC MAKE 163
TC PRESET 112, 171
TC RUN 162
TC/UB DISPLAY 162
TC/UB SET menu 162
Telephoto 43
THUMBNAIL 7, 119
TONE 152
Trademark 197
Troubleshooting 168
TV 124
- U**
- UB PRESET 112
UB TIME REC 163
USB CONNECT 166
USB LUN SET 167
Using your camcorder abroad
..... 184
- V**
- Variable mode 53
VERSION DISPLAY 167
VF COLOR TEMP. 161
VF/LCD PANEL 161
VIDEO OUT 153
Viewfinder 35
 diopter adjustment dial
 35
VOLUME 155
- Volume 84, 121
- W**
- Warning indicators 176
Warning messages 177
WB OUTDOOR LEVEL 149
WB PRESET 149
WB SET 56
WB SHIFT 109
WB TEMP SET 149
White balance 55
WHT BAL 56
Wi-Fi function 87
Wi-Fi SET 163
Wide angle 43
Wired LAN 96
WIRED LAN SET 163
Wireless LAN 92
Wireless Remote Commander,
see Remote control
- X**
- XAVC HD 48, 186
XAVC QFHD 48, 186
XLR AGC LINK 156
XLR SET 156
- Z**
- ZEBRA 158, 171
Zebra 54
Zoom 43
ZOOM DISPLAY 160
Zoom lever 43
Zoom ring 44
ZOOM SET 150

Trademarks

- “XDCAM” logo is a trademark of Sony Corporation.
- “XAVC” and **XAVC** are registered trademarks of Sony Corporation.
- “AVCHD Progressive” and “AVCHD Progressive” logotype are trademarks of Panasonic Corporation and Sony Corporation.
- “Memory Stick,” , “Memory Stick Duo,” **MEMORY STICK DUO**, “Memory Stick PRO Duo,” **MEMORY STICK PRO DUO**, “Memory Stick PRO-HG Duo,” and “MagicGate” are trademarks of Sony Corporation.
- “BRAVIA” is a trademark of Sony Corporation.
- Dolby and the double-D symbol are trademarks of Dolby Laboratories.
- iPhone and iPad are trademarks of Apple Inc., registered in the U.S. and other countries.
- iOS is a registered trademark or trademark of Cisco Systems, Inc. and/or its affiliates in the United States and certain other countries.
- The terms HDMI and HDMI High-Definition Multimedia Interface, and the HDMI Logo are trademarks or registered trademarks of HDMI Licensing LLC in the United States and other countries.
- Intel, Intel Core, and Pentium are trademarks or registered trademarks of Intel Corporation or its subsidiaries in the United States and other countries.
- Android and Google Play are trademarks or registered trademarks of Google Inc.
- Wi-Fi, the Wi-Fi logo, and Wi-Fi Protected Setup are trademarks or registered trademarks of the Wi-Fi Alliance.
- The N-Mark is a trademark or registered trademark of NFC Forum, Inc. in the United States and in other countries.
- Adobe, the Adobe logo, and Adobe Acrobat are either registered trademarks or trademarks of Adobe Systems Incorporated in the United States and/or other countries.
- The SDXC logo is a trademark of SD-3C, LLC.

All other product names mentioned herein may be the trademarks or registered trademarks of their respective companies. Trademarked items are not indicated by © or ™ symbols in this manual.

Notes on the License

THIS PRODUCT IS LICENSED UNDER THE AVC PATENT PORTFOLIO LICENSE FOR THE PERSONAL USE OF A CONSUMER OR OTHER USES IN WHICH IT DOES NOT RECEIVE REMUNERATION TO
(i) ENCODE VIDEO IN COMPLIANCE WITH THE AVC STANDARD (“AVC VIDEO”) AND/OR

(ii) DECODE AVC VIDEO THAT WAS ENCODED BY A CONSUMER ENGAGED IN A PERSONAL ACTIVITY AND/OR WAS OBTAINED FROM A VIDEO PROVIDER LICENSED TO PROVIDE AVC VIDEO. NO LICENSE IS GRANTED OR SHALL BE IMPLIED FOR ANY OTHER USE. ADDITIONAL INFORMATION MAY BE OBTAINED FROM MPEG LA, L.L.C. SEE <[HTTP://WWW.MPEGLA.COM](http://www.mpegla.com)>

Software is installed in your camcorder. We provide this software based on the license agreements of the copyright owners. Based on requests by the owners of copyright of these software applications, we have an obligation to inform you of the following.

Licenses (in English) are recorded in the internal memory of your product. Establish a Mass Storage connection between the product and a computer to read licenses in the “PMHOME” - “LICENSE” folder.

On GNU GPL/LGPL applied software

The software that is eligible for the following GNU General Public License (hereinafter referred to as “GPL”) or GNU Lesser General Public License (hereinafter referred to as “LGPL”) are included in the product.

This informs you that you have a right to have access to, modify, and redistribute source code for these software programs under the conditions of the supplied GPL/LGPL.

Source code is provided on the web. Use the following URL to download it.

<http://oss.sony.net/Products/Linux/>

We would prefer you do not contact us about the contents of source code.

Licenses (in English) are recorded in the internal memory of your product. Establish a Mass Storage connection between the product and a computer to read licenses in the “PMHOME” - “LICENSE” folder.

